



Confidential for
Renesas Electronics
only



datasheet

PRODUCT SPECIFICATION

1/2.7" CMOS WXGA (1280 x 800) high dynamic range (HDR)
high definition (HD) image sensor

OV10635/OV10135

Copyright ©2017 OmniVision Technologies, Inc. All rights reserved.

This document is provided “as is” with no warranties whatsoever, including any warranty of merchantability, non-infringement, fitness for any particular purpose, or any warranty otherwise arising out of any proposal, specification, or sample.

OmniVision Technologies, Inc. and all its affiliates disclaim all liability, including liability for infringement of any proprietary rights, relating to the use of information in this document. No license, expressed or implied, by estoppel or otherwise, to any intellectual property rights is granted herein.

The information contained in this document is considered proprietary to OmniVision Technologies, Inc. and all its affiliates. This information may be distributed to individuals or organizations authorized by OmniVision Technologies, Inc. to receive said information. Individuals and/or organizations are not allowed to re-distribute said information.

Trademark Information

OmniVision and the OmniVision logo are registered trademarks of OmniVision Technologies, Inc. OmniPixel3-HS and a-CSP are trademarks of OmniVision Technologies, Inc.

All other trademarks used herein are the property of their respective owners.

CMOS WXGA (1280x800) high dynamic range (HDR) high definition (HD) image sensor

datasheet (a-CSP)
PRODUCT SPECIFICATION

version 2.4
november 2015

To learn more about OmniVision Technologies, visit www.ovt.com.

applications

- automotive
 - 360° view
 - occupant sensor
 - rear view camera
 - lane departure warning/ lane keep assist
 - blind spot detection
 - night vision
 - pedestrian detection
 - traffic sign recognition

ordering information

- **OV10635-N29Y-PB** (color, lead-free)
129-pin a-CSP™ packed in tray with protective film
- **OV10635-N29Y-RB** (color, lead-free)
129-pin a-CSP™ packed in tape & reel with protective film
- **OV10135-N29Y** (b&w sensor, lead-free)
129-pin a-CSP™ with protective film in tray



note The OV10635/OV10135 is qualified to AEC-Q100 grade-2 specifications

features

- support for image sizes: WXGA (1280x800), HD 720p (1280x720), WVGA (752x480), VGA (640x480), 600x400, CIF (352x288), QVGA (320x240)
- support for output formats: YUV and separated and combined RAW
- parallel DVP interface
- high sensitivity
- automatic exposure/gain
- horizontal and vertical windowing capability
- auto white balance control
- aperture/gamma correction
- serial camera control bus (SCCB) for register programming
- low power consumption
- external frame sync capability
- 50/60 Hz flicker cancellation
- defective pixel correction



note To reduce image artifacts from Infrared light, and provide the best image quality, OmniVision recommends an IR cut filter

key specifications (typical)

- **active array size:** 1280 x 800
- **power supply:**
 - analog: 3.14~3.47V
 - core: 1.425~1.575V
 - I/O: 1.7~3.47V
- **power requirements:**
 - active: 507 mW typical @ 3.3V AVDD, 1.5V DVDD, and 1.8V DOVDD
 - standby: 440 μW typical @ 3.3V AVDD, 1.5V DVDD, and 1.8V DOVDD
- **temperature range:** (see [table 8-2](#))
 - operating: -40°C to +105°C sensor ambient temperature (operating sensor ambient temperatures above +60°C may result in degraded image quality)
- **output interfaces:** 10-bit parallel DVP
- **output formats:** up to 18-bit combined raw, separated 10-bit raw, 8-/10-bit YUV422
- **lens size:** 1/2.7"
- **lens chief ray angle:** 9° (see [figure 10-2](#))
- **input clock frequency:** 6 ~ 27 MHz
- **scan mode:** progressive
- **shutter:** rolling shutter
- **maximum exposure interval:** 838 t_{ROW}
- **maximum image transfer rate:** 30 fps full resolution
- **sensitivity:** 3650 mV/Lux-sec
- **max S/N ratio:** 39 dB
- **dynamic range:** 115 dB
- **pixel size:** 4.2 μm x 4.2 μm
- **dark current:** 2.5mV/s @ 50°C junction temperature
- **image area:** 5510.4 μm x 3418.8 μm
- **package dimensions:** 7795 μm x 7145 μm



note OmniVision recommends a-CSP packages use underfill as part of camera assembly process.



note Register initialization sequence settings must be provided by OmniVision, see [section 7](#).

Confidential for
Renesas Electronics
only

table of contents

1	signal descriptions	1-1
2	system level description	2-1
2.1	overview	2-1
2.2	architecture	2-1
2.3	format and frame rate	2-4
2.4	I/O control	2-4
2.5	system clock control	2-6
2.6	serial camera control bus (SCCB) interface	2-7
2.6.1	data transfer protocol	2-7
2.6.2	message format	2-7
2.6.3	read / write operation	2-7
2.6.4	SCCB timing	2-10
2.7	standby	2-11
2.8	power on timing	2-11
2.9	system control	2-12
3	pixel array structure	3-1
4	image sensor core digital functions	4-1
4.1	mirror and flip	4-1
4.2	test pattern	4-2
4.2.1	color bar	4-2
4.2.2	square	4-3
4.2.3	random data	4-3
4.2.4	transparent effect	4-3
4.2.5	rolling bar effect	4-3
4.3	image cropping and windowing	4-5
4.4	AEC/AGC algorithms	4-7
4.4.1	position weight	4-7
4.4.2	exposure/gain control	4-14
4.5	black level calibration (BLC)	4-33
4.5.1	coarse and fine BLC	4-33
4.5.2	trigger methods	4-33

5 image sensor processor digital functions	5-1
5.1 DSP top level control	5-1
5.2 LENC	5-3
5.3 auto white balance (AWB)	5-6
5.3.1 simple AWB	5-8
5.3.2 CT AWB	5-8
5.3.3 AWB control	5-14
5.3.4 AWB stable range and gain range	5-15
5.4 de-noise (DNS)	5-15
5.5 color interpolation (CIP)	5-19
5.6 color matrix (CMX)	5-25
5.7 auto color saturation	5-31
5.8 combine	5-32
5.9 normalize	5-37
5.10 tone_mapping	5-38
5.11 windowing cropping and subsampling	5-42
5.12 OTP memory read/write	5-43
5.12.1 procedure to read OTP content	5-43
5.12.2 procedure to program OTP content	5-43
5.12.3 power supply requirement for OTP memory programming	5-43
5.13 group control	5-44
5.14 white/black pixel cancellation (WBC)	5-45
6 image sensor output interface digital functions	6-1
6.1 temperature sensor	6-1
6.1.1 temperature sensor calibration procedure	6-2
6.2 embedded line	6-2
6.3 DVP timing	6-3
6.3.1 DVP setup/hold time	6-6

7 register tables	7-1
7.1 system control [0x0100, 0x0103, 0x3000 - 0x3049]	7-1
7.2 analog control [0x3600 - 0x3603, 0x3610 - 0x3618, 0x3620 - 0x3636]	7-6
7.3 sensor control [0x3700 - 0x3710, 0x3712 - 0x374F]	7-7
7.4 timing control [0x3800 - 0x382B, 0x3832 - 0x3835, 0x3844, 0x3848 - 0x3849]	7-8
7.5 OTP control [0x3D00 - 0x3D11, 0x3D1F, 0x3D30 - 0x3D5F]	7-11
7.6 BLC function [0x4000 - 0x405B, 0xC4B7 - 0xC50F, 0x5B1C - 0x5D30]	7-14
7.7 AEC [0x3503, 0x3504, 0x5600 - 0x56EB, 0xC2ED - 0xC51B, 0x5A00 - 0x5C17]	7-25
7.8 ISP control [0x5000 - 0x500E, 0x503B - 0x503E, 0x5040 - 0x5044]	7-50
7.9 LENC control [0x5080 - 0x5098, 0x509C - 0x50B8]	7-53
7.10 white/black pixel cancellation [0x50C1 - 0x50ED, 0x5180 - 0x51A3]	7-56
7.11 AWB [0x5100 - 0x5718, 0xC4B8 - 0xC4DF, 0x5AB0 - 0x5D1B]	7-59
7.12 DNS control [0x5210 - 0x522F, 0x5238 - 0x5256]	7-72
7.13 CIP control [0x5280 - 0x52A1, 0x52C0 - 0x52E1]	7-75
7.14 CMX control [0xC318 - 0xC347]	7-81
7.15 low level filter (LLF) control [0x5380 - 0x538A]	7-87
7.16 combine [0x5400 - 0x542D, 0xC30C - 0xC4CB, 0x5A08 - 0x5A97, 0x5C18 - 0x5C6F]	7-88
7.17 normalize (NMLZ) control [0x5480 - 0x5A98, 0x5C71 - 0x5C78]	7-97
7.18 tone mapping (TMAP) [0x5500 - 0x5511, 0xC4E4 - 0xC4F9, 0x5A9C - 0x5CFB]	7-98
7.19 frame counter (FC) control [0x4200 - 0x4203]	7-107
7.20 format control [0x4300, 0x4302 - 0x4309]	7-108
7.21 VFIFO control [0x4600 - 0x4603, 0x4605 - 0x4613, 0x4620 - 0x4639]	7-109
7.22 digital video port (DVP) control [0x4700 - 0x470D]	7-111
7.23 temperature sensor [0x6700 - 0x6719, 0x3827, 0x6720 - 0x6721]	7-114
7.24 embedded line control [0x6800 - 0x6807]	7-115
7.25 group writer [0x6F00, 0x6F04 - 0x6F1F]	7-116
7.26 macro-code [0xD000 - 0xDFFF]	7-117
8 operating specifications	8-1
8.1 absolute maximum ratings	8-1
8.2 functional temperature	8-1
8.3 DC characteristics	8-2
8.4 AC characteristics	8-3
9 mechanical specifications	9-1
9.1 physical specifications	9-1
9.2 IR reflow specifications	9-3

10 optical specifications	10-1
10.1 sensor array center	10-1
10.2 lens chief ray angle (CRA)	10-2
10.3 spectrum response curve	10-4

Confidential for
Renesas Electronics
only

list of figures

figure 1-1	pin diagram	1-7
figure 2-1	OV10635/OV10135 block diagram	2-2
figure 2-2	OV10635/OV10135 reference schematic	2-3
figure 2-3	PLL control diagram	2-6
figure 2-4	message type	2-7
figure 2-5	SCCB single read from random location	2-8
figure 2-6	SCCB single read from current location	2-8
figure 2-7	SCCB sequential read from random location	2-8
figure 2-8	SCCB sequential read from current location	2-9
figure 2-9	SCCB single write to random location	2-9
figure 2-10	SCCB sequential write to random location	2-9
figure 2-11	SCCB interface timing	2-10
figure 2-12	power on timing diagram	2-11
figure 3-1	sensor array region color filter layout	3-1
figure 4-1	mirror and flip samples	4-1
figure 4-2	color bar types	4-2
figure 4-3	color, black and white square bars	4-3
figure 4-4	transparent effect	4-3
figure 4-5	rolling bar effect	4-3
figure 4-6	frame structure diagram	4-5
figure 4-7	position window diagram	4-8
figure 4-8	position weight diagram	4-12
figure 4-9	AEC/AGC target/range diagram	4-15
figure 5-1	LENC coefficient versus sensor gain	5-3
figure 5-2	RAW domain DNS - long	5-15
figure 5-3	RAW domain DNS - short	5-16
figure 5-4	CIP sharpen curve	5-19
figure 5-5	auto color saturation graph	5-31
figure 6-1	DVP timing diagram	6-3
figure 6-2	DVP setup/hold time diagram	6-6
figure 9-1	package specifications	9-1
figure 9-2	IR reflow ramp rate requirements	9-3

figure 10-1	sensor array center	10-1
figure 10-2	chief ray angle (CRA)	10-2
figure 10-3	spectrum response curve diagram	10-4

Confidential for
Renesas Electronics
only

list of tables

table 1-1	signal descriptions	1-1
table 1-2	configuration under various conditions	1-5
table 2-1	DVP supported formats and frame rates	2-4
table 2-2	driving capability and direction control for I/O pads	2-4
table 2-3	SCCB interface timing specifications	2-10
table 2-4	power on timing	2-11
table 2-5	system control registers	2-12
table 4-1	mirror and flip function control	4-1
table 4-2	test pattern registers	4-4
table 4-3	format related registers	4-6
table 4-4	position window control registers	4-8
table 4-5	AEC position weight registers	4-13
table 4-6	AEC target/range control registers	4-15
table 4-7	BLC control functions	4-33
table 5-1	DSP top registers	5-1
table 5-2	LENC control registers	5-3
table 5-3	AWB registers	5-7
table 5-4	AWB long calibration registers	5-8
table 5-5	AWB short calibration registers	5-11
table 5-6	AWB control registers	5-14
table 5-7	AWB range registers	5-15
table 5-8	DNS control registers	5-16
table 5-9	CIP control registers	5-19
table 5-10	CMX control registers	5-25
table 5-11	auto color saturation control registers	5-31
table 5-12	combine control registers	5-32
table 5-13	normalize control registers	5-37
table 5-14	tone_mapping registers	5-38
table 5-15	WINC control registers	5-42
table 5-16	group control registers	5-44
table 5-17	WBC control registers	5-45
table 6-1	TPM control	6-1

table 6-2	embedded line control	6-2
table 6-3	DVP timing specifications	6-3
table 6-4	DVP setup/hold time	6-6
table 7-1	system control registers	7-1
table 7-2	analog control registers	7-6
table 7-3	sensor control registers	7-7
table 7-4	timing control registers	7-8
table 7-5	OTP control registers	7-11
table 7-6	BLC function registers	7-14
table 7-7	AEC control registers	7-25
table 7-8	ISP control registers	7-50
table 7-9	LENC control registers	7-53
table 7-10	white/black pixel cancellation registers	7-56
table 7-11	AWB control registers	7-59
table 7-12	DNS control registers	7-72
table 7-13	CIP control registers	7-75
table 7-14	CMX control registers	7-81
table 7-15	LLF control registers	7-87
table 7-16	combine control registers	7-88
table 7-17	NMLZ control registers	7-97
table 7-18	TMAP control registers	7-98
table 7-19	FC control registers	7-107
table 7-20	format control registers	7-108
table 7-21	VFIFO control registers	7-109
table 7-22	DVP control registers	7-111
table 7-23	temperature sensor control (TPM)	7-114
table 7-24	embedded line control (EMB) registers	7-115
table 7-25	group writer registers	7-116
table 7-26	macro-code registers	7-117
table 8-1	absolute maximum ratings	8-1
table 8-2	functional temperature	8-1
table 8-3	DC characteristics (-30°C < T _J < 115°C)	8-2
table 8-4	AC characteristics (T _A = 25°C, VDD-A = 3.3V, VDD-IO = 1.8V)	8-3
table 8-5	timing characteristics	8-3
table 9-1	package dimensions	9-1

table 9-2	reflow conditions	9-3
table 10-1	CRA versus image height plot	10-2

Confidential for
Renesas Electronics
only

Confidential for
Renesas Electronics
only

1 signal descriptions

table 1-1 lists the signal descriptions and their corresponding pin numbers for the OV10635/OV10135 image sensor. The package information is shown in **section 9**.

table 1-1 signal descriptions (sheet 1 of 5)

pin number	signal name	pin type	description
A2	AVDD	power	3.3V power
A3	AGND	ground	analog ground
A4	SVDD	power	3.3V power
A5	DOGND	ground	I/O ground
A6	DOGND	ground	I/O ground
A7	SVDD	power	3.3V power
A8	SGND	ground	sensor array ground
A9	DOVDD	power	1.7 ~ 3.6V power
A10	DOGND	ground	I/O ground
A11	DEVDD	power	analog power
A12	SVDD	power	3.3V power
A13	VF4 ^a	reference	internal analog reference
B1	AVDD	power	3.3V power
B2	AGND	ground	analog ground
B3	AVDD	power	3.3V power
B4	SGND	ground	sensor array ground
B5	DOGND	ground	I/O ground
B6	DOGND	ground	I/O ground
B7	DOGND	ground	I/O ground
B8	DOGND	ground	I/O ground
B9	DOGND	ground	I/O ground
B10	DOGND	ground	I/O ground
B11	DOGND	ground	I/O ground
B12	SGND	ground	sensor array ground
B13	AGND	ground	analog ground

table 1-1 signal descriptions (sheet 2 of 5)

pin number	signal name	pin type	description
B14	AVDD	power	3.3V power
C1	AGND	ground	analog ground
C2	AVDD	power	3.3V power
C3	AGND	ground	analog ground
C4	DOGND	ground	I/O ground
C5	DOGND	ground	I/O ground
C6	DOGND	ground	I/O ground
C7	DOGND	ground	I/O ground
C8	DOGND	ground	I/O ground
C9	DOGND	ground	I/O ground
C10	DOGND	ground	I/O ground
C11	DOGND	ground	I/O ground
C12	VF ^a	reference	internal analog reference
C13	VH ^a	reference	internal analog reference
C14	AGND	ground	analog ground
D1	DOGND	ground	I/O ground
D2	DOGND	ground	I/O ground
D3	DOGND	ground	I/O ground
D4	DOGND	ground	I/O ground
D12	DOGND	ground	I/O ground
D13	DOGND	ground	I/O ground
D14	AVDD	power	3.3V power
E1	DOGND	ground	I/O ground
E2	DOGND	ground	I/O ground
E3	DOGND	ground	I/O ground
E4	DOGND	ground	I/O ground
E12	DOGND	ground	I/O ground
E13	EVDD	power	PLL digital power (connect to DVDD)
E14	PVDD	power	PLL analog power
F1	TM	input	test mode, active high

table 1-1 signal descriptions (sheet 3 of 5)

pin number	signal name	pin type	description
F2	DOGND	ground	I/O ground
F3	DOGND	ground	I/O ground
F4	DOGND	ground	I/O ground
F12	DOGND	ground	I/O ground
F13	XVCLK	input	system clock input
F14	EGND	ground	PLL ground
G1	AGND	ground	analog ground
G2	PWDN	input	input (active high with pull down resistor)
G3	DOGND	ground	I/O ground
G4	DOGND	ground	I/O ground
G12	DOGND	ground	I/O ground
G13	DGND	ground	ground for digital circuit
G14	DOVDD	power	1.7 ~ 3.6V power
H1	AVDD	power	3.3V power
H2	DOGND	ground	I/O ground
H3	DOGND	ground	I/O ground
H4	DOGND	ground	I/O ground
H12	DOGND	ground	I/O ground
H13	DOGND	ground	I/O ground
H14	DVDD	power	1.5V power
J1	TMB	input	test mode (active low)
J2	RESETB	input	reset input (active low with internal pull up resistor)
J3	DOGND	ground	I/O ground
J4	DOGND	ground	I/O ground
J12	DOGND	ground	I/O ground
J13	GPIO2/SID2	I/O	general purpose IO2 / SCCB address select 2
J14	GPIO3	I/O	general purpose IO3
K1	DVDD	power	1.5V power
K2	DGND	ground	ground for digital circuit
K3	FSIN	I/O	frame sync input

table 1-1 signal descriptions (sheet 4 of 5)

pin number	signal name	pin type	description
K4	DOGND	ground	I/O ground
K12	DOGND	ground	I/O ground
K13	DVDD	power	1.5V power
K14	DGND	ground	ground for digital circuit
L1	DOVDD	power	1.7 ~ 3.6V power
L2	SIOC	input	SCCB interface input clock
L3	DGND	ground	ground for digital circuit
L4	DOGND	ground	I/O ground
L5	DOGND	ground	I/O ground
L6	DOGND	ground	I/O ground
L7	DOGND	ground	I/O ground
L8	DOGND	ground	I/O ground
L9	DOGND	ground	I/O ground
L10	DOGND	ground	I/O ground
L11	DOGND	ground	I/O ground
L12	GPIO0/SID0	I/O	general purpose IO/ SCCB address select 0
L13	DOGND	ground	I/O ground
L14	DOVDD	power	1.7 ~ 3.6V power
M1	SIOD	I/O	SCCB interface data
M2	DOGND	ground	I/O ground
M3	D9	I/O	video data output[9]
M4	D7	I/O	video data output[7]
M5	D6	I/O	video data output[6]
M6	D4	I/O	video data output[4]
M7	DGND	ground	ground for digital circuit
M8	D3	I/O	video data output[3]
M9	D1	I/O	video data output[1]
M10	DOVDD	power	1.7 ~ 3.6V power
M11	PCLK	I/O	video output clock
M12	VSYNC	I/O	vertical signal video output

table 1-1 signal descriptions (sheet 5 of 5)

pin number	signal name	pin type	description
M13	DGND	ground	ground for digital circuit
M14	GPIO1/SID1	I/O	general purpose IO1/ SCCB address select 1
N2	DVDD	power	1.5V power
N3	D8	I/O	video data output[8]
N4	DOGND	ground	I/O ground
N5	DOVDD	power	1.7 ~ 3.6V power
N6	D5	I/O	video data output[5]
N7	DVDD	power	1.5V power
N8	DOVDD	power	1.7 ~ 3.6V power
N9	D2	I/O	video data output[2]
N10	D0	I/O	video data output[0]
N11	DOGND	ground	I/O ground
N12	HREF	I/O	video output horizontal signal
N13	DVDD	power	1.5V power

a. internal reference voltages require a 0.1 μ F capacitor to AGND

table 1-2 configuration under various conditions (sheet 1 of 2)

pin number	signal name	RESETB = 0	RESETB = 1 PWDN = 0	RESETB = 1 PWDN = 1
F1	TM	input	input	input
F13	XVCLK	input	input	input
G2	PWDN	input	input	input
J1	TMB	input	input	input
J2	RESETB	input	input	input
J13	GPIO2/SID2	input	input (configurable)	input (configurable)
J14	GPIO3	input	input (configurable)	input (configurable)
K3	FSIN	input	input	high-z
L2	SIOC	input	input	high-z
L12	GPIO0/SID0	input	input (configurable)	input (configurable)

table 1-2 configuration under various conditions (sheet 2 of 2)

pin number	signal name	RESETB = 0	RESETB = 1 PWDN = 0	RESETB = 1 PWDN = 1
M1	SIOD	open-drain	open-drain	open-drain
M3	D9	output	output (configurable)	output (configurable)
M4	D7	output	output (configurable)	output (configurable)
M5	D6	output	output (configurable)	output (configurable)
M6	D4	output	output (configurable)	output (configurable)
M8	D3	output	output (configurable)	output (configurable)
M9	D1	output	output (configurable)	output (configurable)
M11	PCLK	output	output (configurable)	output (configurable)
M12	VSYNC	output	output (configurable)	output (configurable)
M14	GPIO1/SID1	input	input (configurable)	input (configurable)
N3	D8	output	output (configurable)	output (configurable)
N6	D5	output	output (configurable)	output (configurable)
N9	D2	output	output (configurable)	output (configurable)
N10	D0	output	output (configurable)	output (configurable)
N12	HREF	output	output (configurable)	output (configurable)

figure 1-1 pin diagram

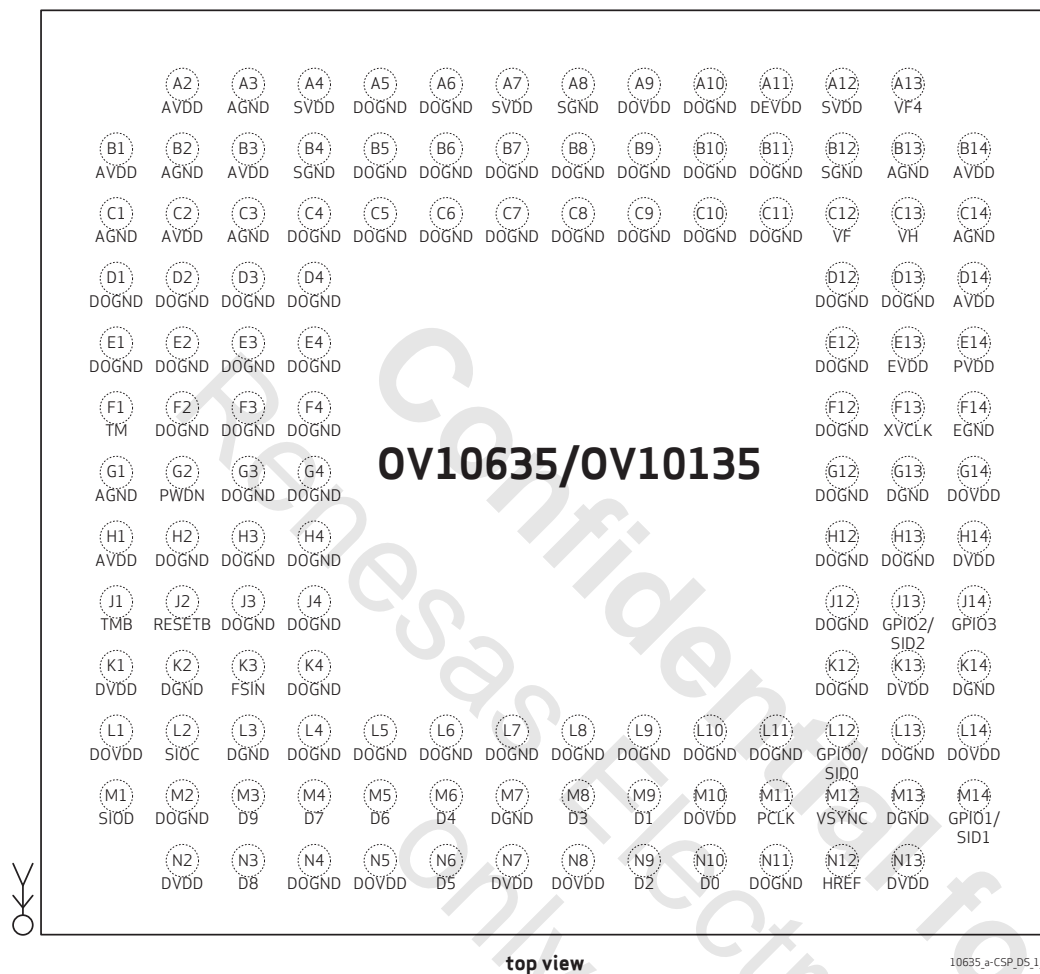

Confidential for
Renesas Electronics
only

2 system level description

2.1 overview

The OV10635 (color) and OV10135 (b&w) image sensors are low voltage, high performance 1/2.7-inch 1 Megapixel CMOS image sensors that provide the full functionality of a single chip 1280x800 camera using OmniPixel3-HS™ technology in a small footprint package. They provide full-frame, sub-sampled and windowed images in various formats via the control of the Serial Camera Control Bus (SCCB) interface.

The OV10635/OV10135 has an image array capable of operating at up to 30 frames per second (fps) in full resolution with complete user control over image quality, formatting and output data transfer. All required image processing functions, including exposure control, white balance, defective pixel canceling, etc., are programmable through the SCCB interface. In addition, OmniVision image sensors use proprietary sensor technology to improve image quality by reducing or eliminating common lighting/electrical sources of image contamination, such as fixed pattern noise, smearing, etc., to produce a clean, fully stable image.

2.2 architecture

The OV10635/OV10135 sensor core generates streaming pixel data at a constant frame rate, indicated by HREF, VSYNC, and PCLK.

The timing generator outputs clocks to access the rows of the imaging array, precharging and sampling the rows of the array sequentially. In the time between precharging and sampling a row, the charge in the pixels decrease with exposure to incident light. This is the exposure time in rolling shutter architecture.

The exposure time is controlled by adjusting the time interval between precharging and sampling. After the data of the pixels in the row has been sampled, it is processed through analog circuitry to correct the offset and multiply the data with corresponding gain. Following analog processing is the ADC.

figure 2-1 OV10635/OV10135 block diagram

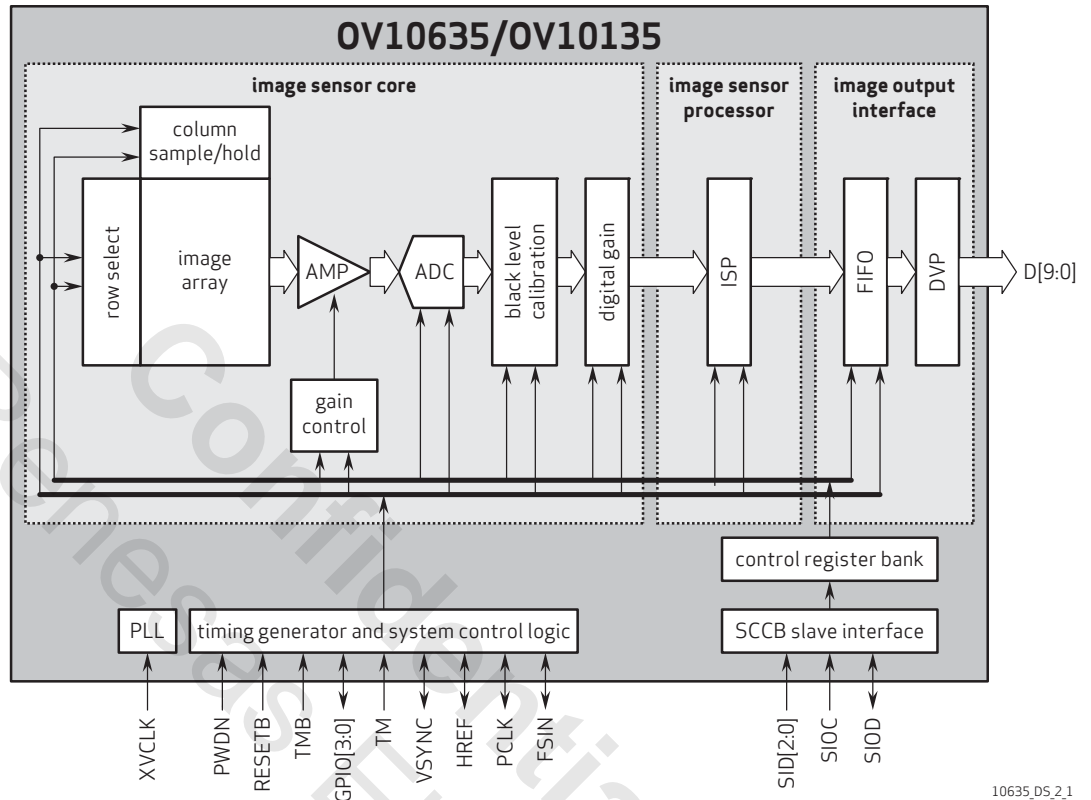

10635_DS_2_1

figure 2-2 OV10635/OV10135 reference schematic

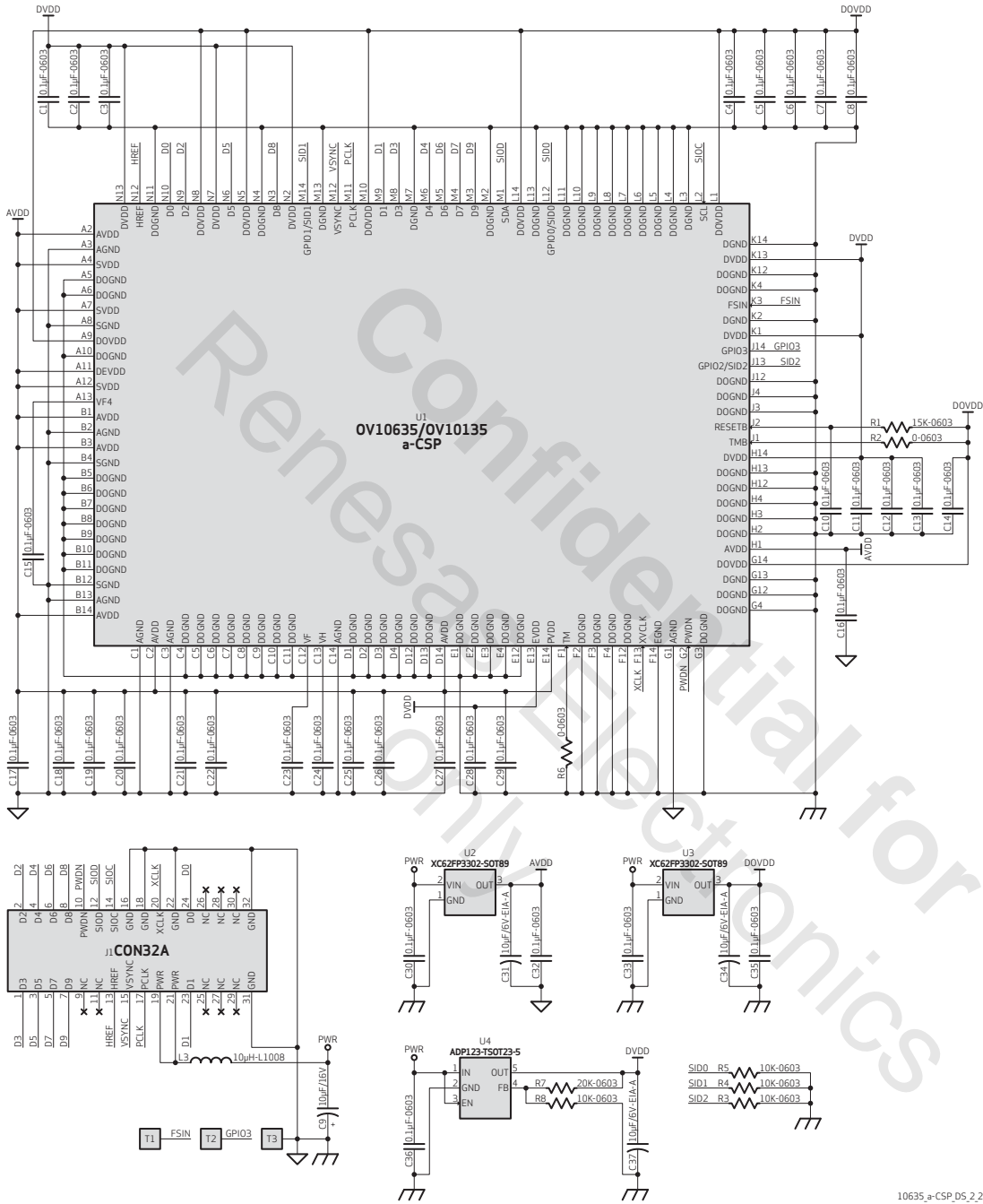

10635_a-CSP_DS_2.2

2.3 format and frame rate

The OV10635/OV10135 supports 8/10-bit YUV, up to 18-bit combined RAW and separated 10-bit RAW. For further information on the registers affecting windowing, cropping, and skipping (subsampling), see [section 4.3](#).

table 2-1 DVP supported formats and frame rates

format	resolution	frame rate	methodology
WXGA	1280 x 800	30 fps	full progressive
HD 720p	1280 x 720	30 fps	cropping
WVGA	752 x 480	30 fps	cropping
VGA	640 x 480	30 fps	cropping
640 x 400	640 x 400	60 fps	skipping, cropping
CIF	352 x 288	60 fps	skipping, cropping
QVGA	320 x 240	60 fps	skipping, cropping

2.4 I/O control

The OV10635/OV10135 I/O pad direction and driving capability can be easily adjusted. [table 2-2](#) lists the driving capability and direction control registers of the I/O pads.

table 2-2 driving capability and direction control for I/O pads (sheet 1 of 2)

function	register	R/W	description
output drive capability control	0x3011	RW	Bit[7:6]: output drive capability 00: 1x 01: 2x 10: 3x 11: 4x
D[9:0] I/O control	0x3000[1:0], 0x3001[7:0]	RW	input/output selection for the D[9:0] pins 0: input 1: output
D[9:0] output select	0x300E[1:0], 0x300F[7:0]	RW	output selection for the D[9:0] pins 0: video data output 1: register-controlled value, refer to registers {0x3008[1:0], 0x3009[7:0]} and {0x3008[1:0], 0x3001[7:0]}
D[9:0] output value	0x3008[1:0], 0x3009[7:0]	RW	D[9:0] output value

table 2-2 driving capability and direction control for I/O pads (sheet 2 of 2)

function	register	R/W	description
VSYNC I/O control	0x3002	RW	Bit[7]: input/output selection for the VSYNC pin 0: input 1: output
VSYNC output select	0x3010	RW	Bit[7]: output selection for the VSYNC pin 0: vertical sync output 1: register-controlled value, refer to register 0x300D[7] and 0x3002[7]
VSYNC output value	0x300D	RW	Bit[7]: VSYNC output value
HREF I/O control	0x3002	RW	Bit[6]: input/output selection for the HREF pin 0: input 1: output
HREF output select	0x3010	RW	Bit[6]: output selection for the HREF pin 0: horizontal reference output 1: register-controlled value, refer to register 0x300D[6] and 0x3002[6]
HREF output value	0x300D	RW	Bit[6]: HREF output value
PCLK I/O control	0x3002	RW	Bit[5]: input/output selection for the PCLK pin 0: input 1: output
PCLK output select	0x3010	RW	Bit[5]: output selection for the PCLK pin 0: pixel clock output 1: register-controlled value, refer to register 0x300D[5] and 0x3002[5]
PCLK output value	0x300D	RW	Bit[5]: PCLK output value

2.5 system clock control

The OV10635/OV10135 has an on-chip PLL which generates the maximum 96 MHz system clock from a 6~27 MHz input clock. A programmable clock divider is provided to generate different frequencies for the system. PLL adjustment should be applied while the sensor is in software standby mode to prevent image corruption or unstable performance. Real-time adjustment is not allowed.

figure 2-3 PLL control diagram

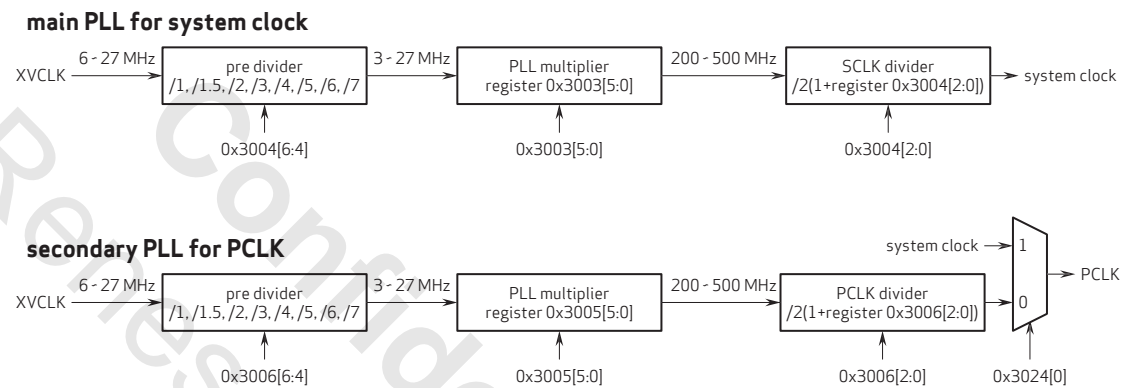

10635_DS_2.3

2.6 serial camera control bus (SCCB) interface

The Serial Camera Control Bus (SCCB) interface controls the image sensor operation. Refer to the *OmniVision Technologies Serial Camera Control Bus (SCCB) Specification* for detailed usage of the serial control port.

2.6.1 data transfer protocol

The data transfer of the OV10635/OV10135 follows the SCCB protocol.

2.6.2 message format

The OV10635/OV10135 supports the message format shown in **figure 2-4**. The 7-bit SCCB slave device default address is 0x30, the low 3 bits can be configured from pad GPIO[2:0]/SID[2:0], which is controlled by 0x300C[0]. The repeated START (Sr) condition is shown in **figure 2-5** and **figure 2-7**.

figure 2-4 message type

message type: 16-bit sub-address, 8-bit data, and 7-bit slave address

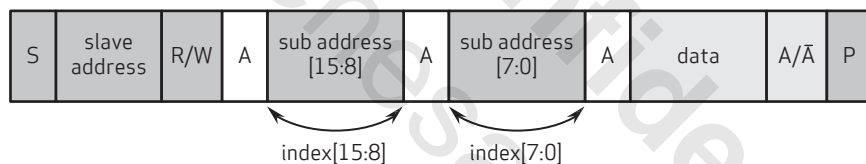

from slave to master

from master to slave

direction depends on operation

S START condition

P STOP condition

Sr repeated START condition

A acknowledge

Ā negative acknowledge

10635_DS_2_4

2.6.3 read / write operation

The OV10635/OV10135 supports four different read operations and two different write operations:

- a single read from random locations
- a sequential read from random locations
- a single read from current location
- a sequential read from current location
- single write to random locations
- sequential write starting from random location

The sub-address in the sensor automatically increases by one after each read/write operation.

In a single read from random locations, the master does a dummy write operation to desired sub-address, issues a repeated start condition and then addresses the camera again with a read operation. After acknowledging its slave address, the camera starts to output data onto the SIOD line as shown in **figure 2-5**. The master terminates the read operation by setting a negative acknowledge and stop condition.

figure 2-5 SCCB single read from random location

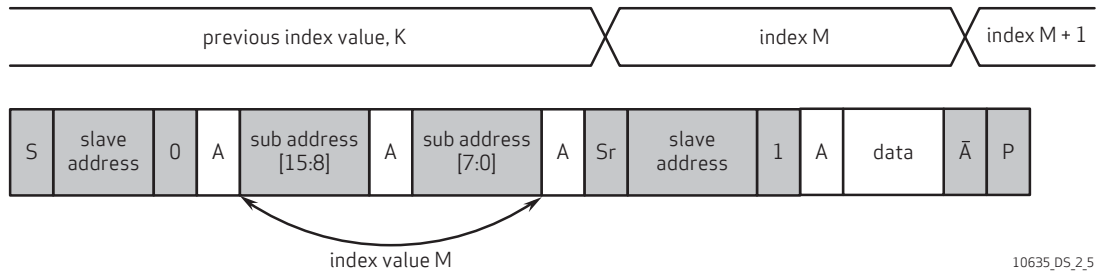

If the host addresses the camera with read operation directly without the dummy write operation, the camera responds by setting the data from last used sub-address to the SIOD line as shown in **figure 2-6**. The master terminates the read operation by setting a negative acknowledge and stop condition.

figure 2-6 SCCB single read from current location

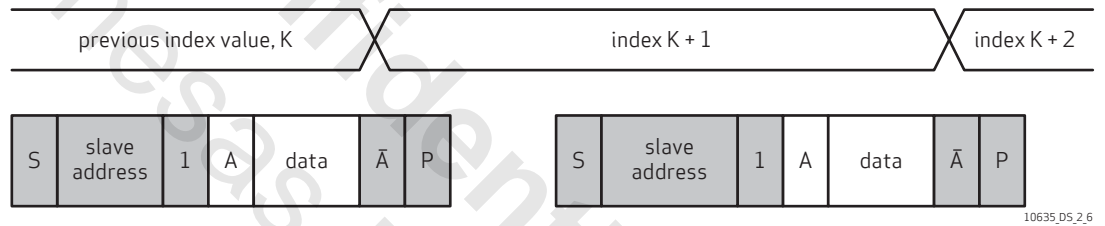

The sequential read from a random location is illustrated in **figure 2-7**. The master does a dummy write to the desired sub-address, issues a repeated start condition after acknowledge from slave and addresses the slave again with read operation. If a master issues an acknowledge after receiving data, it acts as a signal to the slave that the read operation shall continue from the next sub-address. When master has read the last data byte, it issues a negative acknowledge and stop condition.

figure 2-7 SCCB sequential read from random location

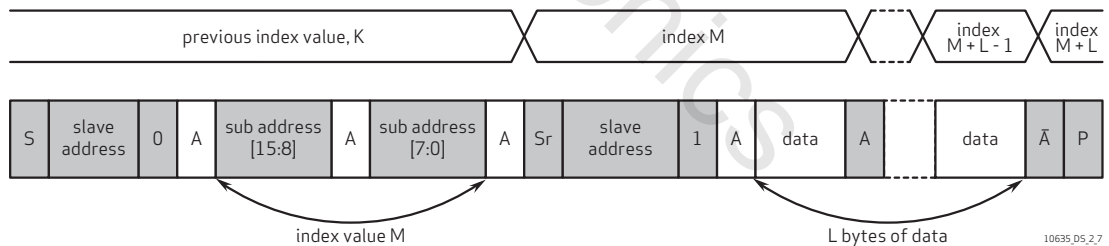

The sequential read from current location is similar to a sequential read from a random location. The only exception is that there is no dummy write operation, as shown in **figure 2-8**. The master terminates the read operation by setting a negative acknowledge and stop condition.

figure 2-8 SCCB sequential read from current location

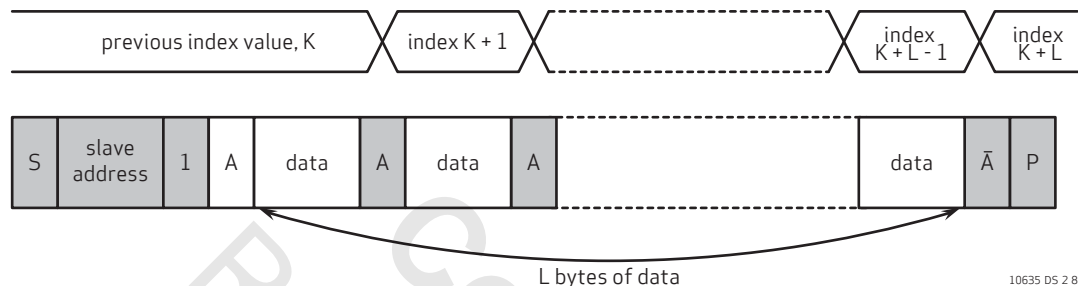

The write operation to a random location is illustrated in **figure 2-9**. The master issues a write operation to the slave, sets the sub-address and data correspondingly after the slave has acknowledged. The write operation is terminated with a stop condition from the master.

figure 2-9 SCCB single write to random location

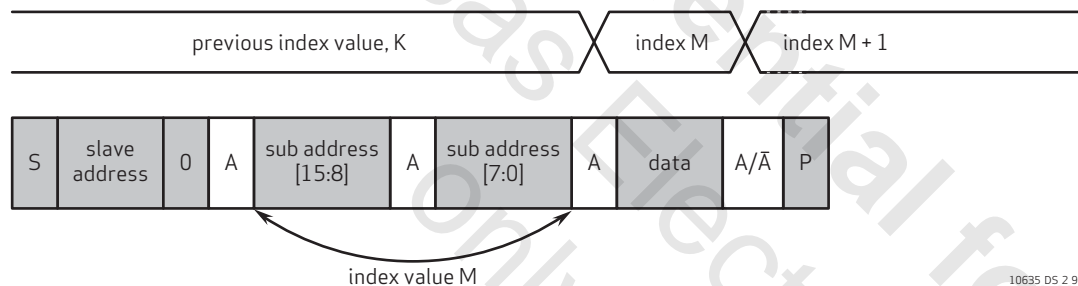

The sequential write is illustrated in **figure 2-10**. The slave automatically increments the sub-address after each data byte. The sequential write operation is terminated with stop condition from the master.

figure 2-10 SCCB sequential write to random location

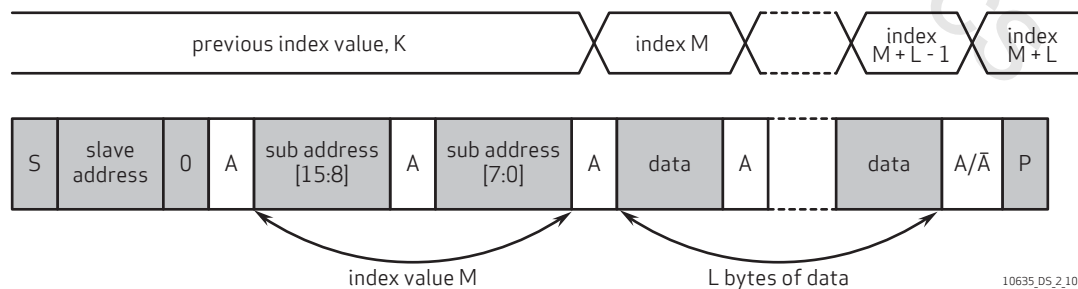

2.6.4 SCCB timing

figure 2-11 SCCB interface timing

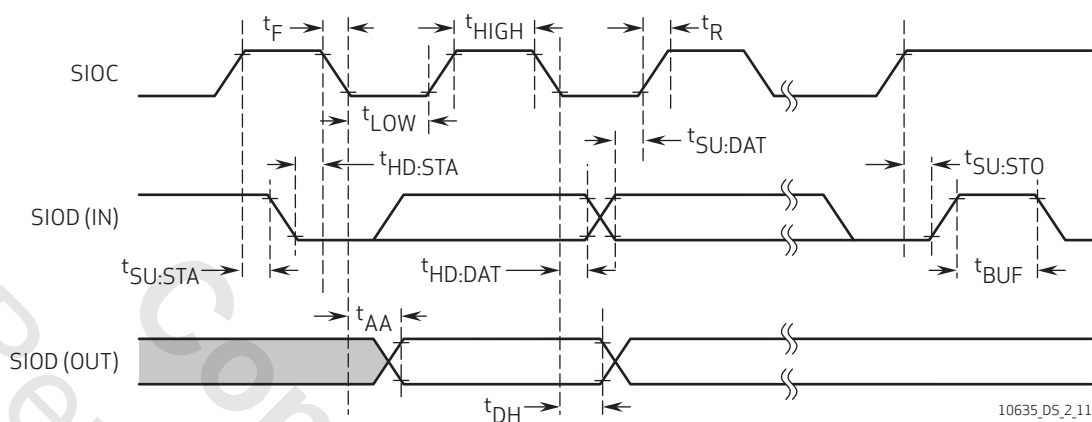

10635_DS_2_11

table 2-3 SCCB interface timing specifications^{ab}

symbol	parameter	min	typ	max	unit
f_{SIOC}	clock frequency			400	kHz
t_{LOW}	clock low period	1.3			μs
t_{HIGH}	clock high period	0.6			μs
t_{AA}	SIOC low to data out valid	0.1		0.9	μs
t_{BUF}	bus free time before new start	1.3			μs
$t_{HD:STA}$	start condition hold time	0.6			μs
$t_{SU:STA}$	start condition setup time	0.6			μs
$t_{HD:DAT}$	data in hold time	0			μs
$t_{SU:DAT}$	data in setup time	0.1			μs
$t_{SU:STO}$	stop condition setup time	0.6			μs
t_R, t_F	SCCB rise/fall times			0.3	μs
t_{DH}	data out hold time	0.05			μs

- SCCB timing is based on 400kHz mode
- timing measurement shown at the beginning of the rising edge or the end of the falling edge signifies 30%, timing measurement shown in the middle of the rising/falling edge signifies 50%, timing measurement shown at the end of rising edge or the beginning of the falling edge signifies 70%

2.7 standby

To initiate hardware standby mode, the PWDN pin must be tied to high. When this occurs, the OV10635/OV10135 internal device clock is halted and all internal counters are reset and registers are maintained.

2.8 power on timing

figure 2-12 power on timing diagram

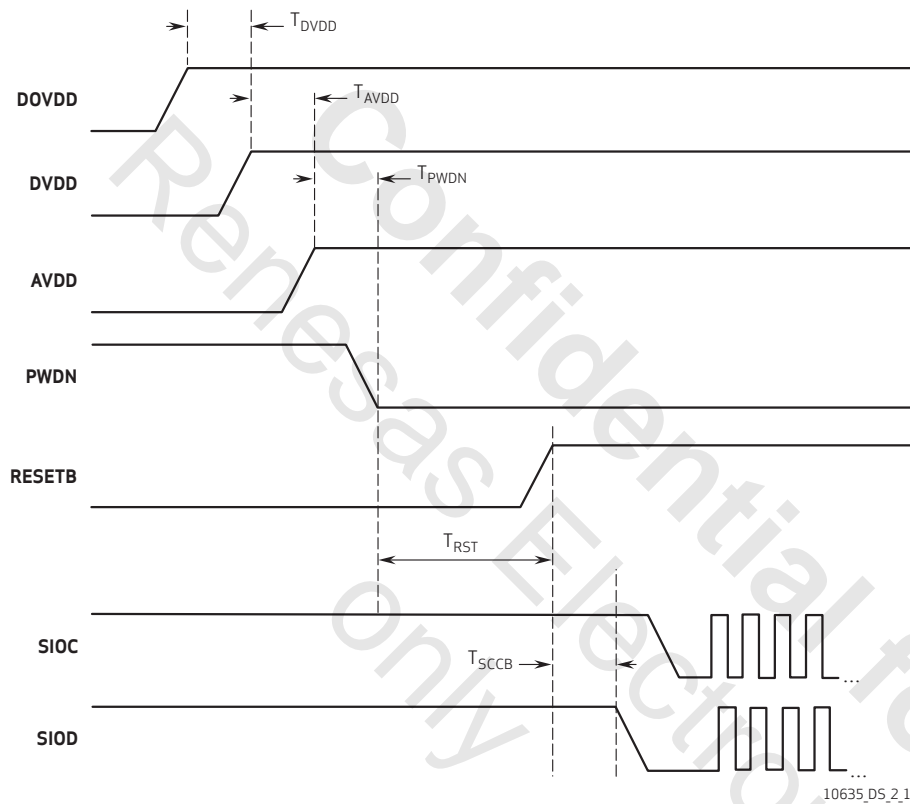

table 2-4 power on timing

parameter	min	max	unit
T_{DVDD}	>0	10	ms
T_{AVDD}	>0	n/a	ms
T_{PWDN}	>1	n/a	ms
T_{RST}	>200	n/a	μ s
T_{SCCB}	>2048	n/a	XVCLK cycles

2.9 system control

table 2-5 system control registers

address	register name	default value	R/W	description
0x0100	STREAM MODE	0x00	RW	Bit[7:1]: Not used Bit[0]: Turn on video stream after power up, always set to "1" 0: Not used 1: Stream on
0x0103	SOFTWARE RESET	0x00	RW	Software Reset will Auto Clear by Itself to 0x00

Confidential for
Renesas Electronics
only

3 pixel array structure

The OV10635/OV10135 sensor has an image array of 1312 columns by 828 rows. **figure 3-1** shows a cross-section of the image sensor array.

The color filters are arranged in a Bayer pattern. The primary color BG/GR array is arranged in line-alternating fashion. Of the 828 rows, 814 rows are active rows and can be output. The other rows are used for black level calibration and interpolation.

The sensor array design is based on a read-out system with line-by-line transfer and an electronic shutter with a synchronous pixel read-out scheme.

figure 3-1 sensor array region color filter layout

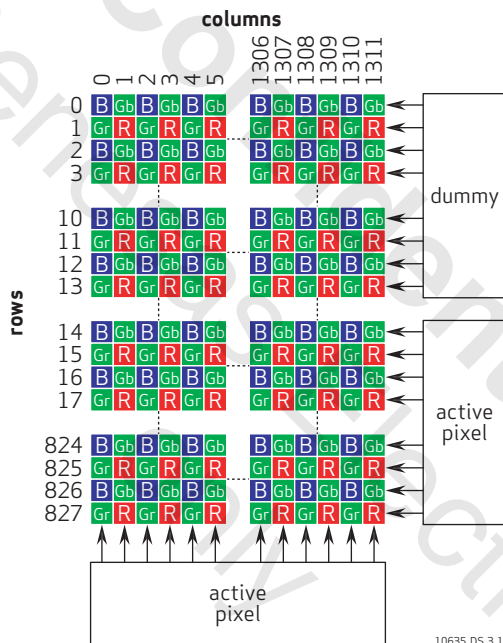

10635_05_3_1

Confidential for
Renesas Electronics
only

4 image sensor core digital functions

4.1 mirror and flip

The OV10635/OV10135 provides mirror mode, which reverses the sensor data read-out order horizontally, and flip mode which reverses it vertically (see [figure 4-1](#)).

figure 4-1 mirror and flip samples

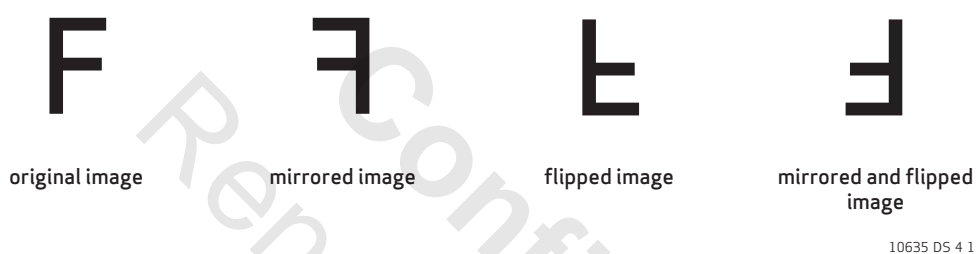

table 4-1 mirror and flip function control^a

function	register	description
mirror	0x381D	Bit[1:0]: mirror ON/OFF select 00: horizontal mirror OFF 01: not allowed 10: not allowed 11: horizontal mirror ON
flip	0x381C	Bit[7:6]: flip ON/OFF select 00: vertical flip OFF 01: not allowed 10: not allowed 11: vertical flip ON

a. when mirror mode is on, register 0x6900[0] needs to be set to 0x01 in order to ensure correct color output

4.2 test pattern

For testing purposes, the OV10635/OV10135 offers one type of analog test pattern and three types of digital test patterns. The analog test pattern is a color bar overlaid on an image, which can be enabled by register 0x370A[2]. The digital test patterns include color bar, square and random data. The OV10635/OV10135 also offers two digital effects for the test patterns: transparent effect and rolling bar effect. The digital test pattern function is enabled by register 0x503D[7] and the pattern is selected by register 0x503E[1:0].

The digital test pattern passes through the pipeline. To get a consistent output pattern, register 0x5000 must be set to 0x78 to turn off some of the ISP blocks and register 0x3042 must be set to 0xF9 after the software reset and before enabling the test pattern.

4.2.1 color bar

There are four types of color bars shown in **figure 4-2**.

figure 4-2 color bar types



10635_DS_4.2

4.2.2 square

There are two types of square test patterns: color square and black-white square.

figure 4-3 color, black and white square bars

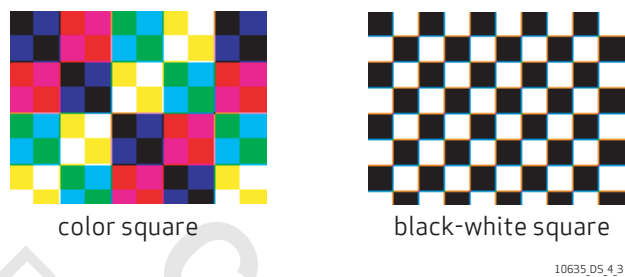

4.2.3 random data

There are two types of random data test patterns: frame-changing and frame-fixed random data.

4.2.4 transparent effect

figure 4-4 is an example which shows a transparent color bar image.

figure 4-4 transparent effect



4.2.5 rolling bar effect

figure 4-5 is an example which shows a rolling bar on color bar image.

figure 4-5 rolling bar effect



table 4-2 test pattern registers

address	register name	default value	R/W	description
0x370A	SENSOR REG0A	0x00	RW	Bit[2]: Analog color bar enable 0: Disable 1: Enable
0x503D	ISP CTRL3D	0x00	RW	Bit[7]: Digital test pattern enable 0: Disable 1: Enable Bit[5:4]: Color bar type (see figure 4-2) Bit[2]: Rolling horizontal bar in color bar test pattern 0: Disable rolling bar 1: Enable rolling bar Bit[1:0]: Debug control Changing this value is not allowed
0x503E	ISP CTRL3E	0x00	RW	Bit[7:4]: Seed of random number Initial seed for random data pattern Bit[3]: B&W square test pattern enable 0: Output square is color square 1: Output square is black-white square Bit[2]: Transparent enable mode 0: Disable 1: Enable Bit[1:0]: Test pattern type 00: Color bar 01: Random data 10: Square 11: Not allowed

Renesas Confidential for
only Electronics

4.3 image cropping and windowing

An image cropping area is defined by four parameters: H_crop_start , H_crop_end , V_crop_start , V_crop_end ; windowing area is defined by four parameters, horizontal start (H_win_off), horizontal width (H_output_size), vertical start (V_win_off), and vertical height (V_output_size). By properly setting the parameters, any portion within the sensor array can be cropped as a visible area. Windowing is achieved by simply masking off the pixels outside of the window; thus, the original timing is not affected. Also, it will not conflict with the flip and mirror functions. The selected window size must be equal to or smaller than the crop size.

The OV10635/OV10135 can:

- support any size vertical crop
- support three size horizontal crop: 1312, 768 and 656
- support HDR mode
- support non-HDR mode
- support mirror and flip mode
- support any size windowing

figure 4-6 frame structure diagram

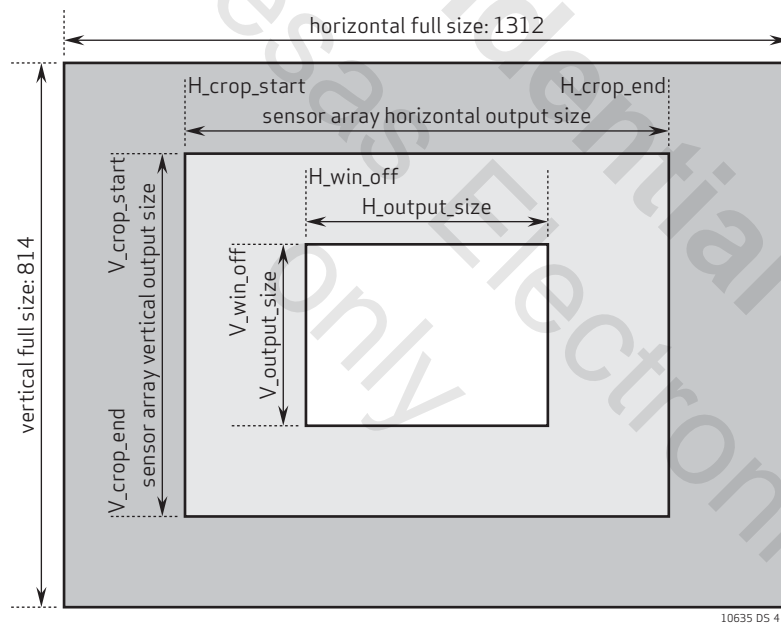

VTS is adjusted by registers (0x6E42[7:0], 0x6E43[7:0]). The reference initialization settings must be used for these two registers to be valid.

table 4-3 format related registers (sheet 1 of 2)

address	default value	R/W	description
0x3621	0x03	RW	Bit[4:3]: Horizontal crop mode select 00: Full size 01: Horizontal crop to 768 10: Horizontal crop to 656 11: Not used Bit[2:0]: Analog delay option
0x3802	0x00	RW	Vertical Crop Start Address High Byte
0x3803	0x00	RW	Vertical Crop Start Address Low Byte
0x3806	0x03	RW	Vertical Crop End Address High Byte
0x3807	0x28	RW	Vertical Crop End Address Low Byte
0x3808	0x05	RW	DVP Horizontal Output Size High Byte
0x3809	0x00	RW	DVP Horizontal Output Size Low Byte
0x380A	0x03	RW	DVP Vertical Output Size High Byte
0x380B	0x20	RW	DVP Vertical Output Size Low Byte
0x380C	0x07	RW	Line Length High Byte
0x380D	0x70	RW	Line Length Low Byte
0x380E	0x03	RW	Frame Length High Byte
0x380F	0x48	RW	Frame Length Low Byte
0x3810	0x00	RW	Horizontal ISP Window Offset High Byte
0x3811	0x00	RW	Horizontal ISP Window Offset Low Byte
0x3812	0x00	RW	Vertical ISP Window Offset High Byte
0x3813	0x00	RW	Vertical ISP Window Offset Low Byte
0x381C	0x00	RW	Bit[0]: Vertical sub-sample in array
0x5005	0x08	RW	Bit[7]: Vertical sub-sample in ISP Bit[0]: VAP enable
0x3007	0x01	RW	Bit[3:0]: DVP PCLK divider Used when ISP horizontal subsample
0x4600	0x04	RW	Bit[2]: VFIFO 2 bytes input 0: Raw10 mode 1: Other mode

table 4-3 format related registers (sheet 2 of 2)

address	default value	R/W	description
0x4300	0xF8	RW	Bit[7:4]: Output format select 0x3: YUV mode 0xF: RAW mode Others: Not allowed Bit[3:0]: pix_order_ctrl 1000: YUYV 1001: YVYU 1010: UYVY 1011: VYUY

4.4 AEC/AGC algorithms

In the OV10635/OV10135, the exposure/gain control is designed to adjust the weighted frame average to a user defined range. The weight of each pixel includes three parts: position weight, combination weight and luminance weight. Instead of using the whole frame, the statistic window can be defined manually with the left-top corner {0x5601[2:0], 0x5602}, {0x5603[1:0], 0x5604}, width {0x5605[2:0], 0x5606} and height {0x5607[1:0], 0x5608}. The pixels outside of the window will not be included in the weighted average.

There are three target modes: AA, AB and ABC mode. This is defined by the target mode register 0xC450[1:0].

The AEC/AGC algorithms support HDR mode and non-HDR mode. Register 0xC454[0] must be set to 1 for non-HDR mode and 0 for HDR mode.

In non-HDR mode, the sensor only uses one sub-pixel. In HDR mode, the AEC/AGC needs to determine the exposure and the gain for the two sub-pixels. It supports auto ratio mode, fixed ratio mode and geometric proportion mode.

Auto ratio mode means the long exposure/short exposure ratio changes automatically according to the scene. It supports all modes (AA,AB and ABC). To enable auto ratio mode, the fixed ratio mode register 0xC456[0] and the geometric proportion mode register 0xC457[0] must be set to 0.

Fixed ratio mode means the long exposure/short exposure ratio is fixed regardless of the scene. It supports all modes (AA, AB and ABC). To enable fixed ratio mode, register 0xC456[0] should be set to 1. The fixed ratio can be set by register 0xC490. In this mode, the geometric proportion mode register 0xC457[0] should be set to 0.

Geometric proportion mode works only in AB or ABC modes. This means that the relationship between the stable range of AB or ABC frame is fixed. The fixed relationship can be adjusted by registers 0xC492 and 0xC493. In geometric proportion mode, the register 0xC457[0] must be set to be 1.

4.4.1 position weight

The position weight is decided by the position of the pixel, which also includes two independent parts: the windowing weight and the region of interest (ROI) weight. The windowing weight function divides the statistic window into 13 windows as shown in [figure 4-7](#) and each window has a weight defined by one of registers 0x562E~0x5647. Also, the size and position of the center 3×3 windows can be defined with registers 0x5609~0x5618. The ROI weight is determined

by whether the pixel is within the ROI region which is defined with the registers 0x5619~0x5628. The weight of pixels, which are in ROI region is defined with register 0x562A (for long exposure channel) or 0x562C (for short exposure channel). The weight of other pixels is defined with register 0x562B (for long exposure channel) and 0x562D (for short exposure channel). The long ROI shift (0x5629[5:3]) and short ROI shift (0x5629[2:0]) control the precision of the long ROI weight and the short ROI weight, separately. The weight given to a window is relative to the other windows. Thus, a window weighted "4" has four times the weight as one weighted "1". The default is that all windows are weighted "1", and thus, all are weighted evenly.

figure 4-7 position window diagram

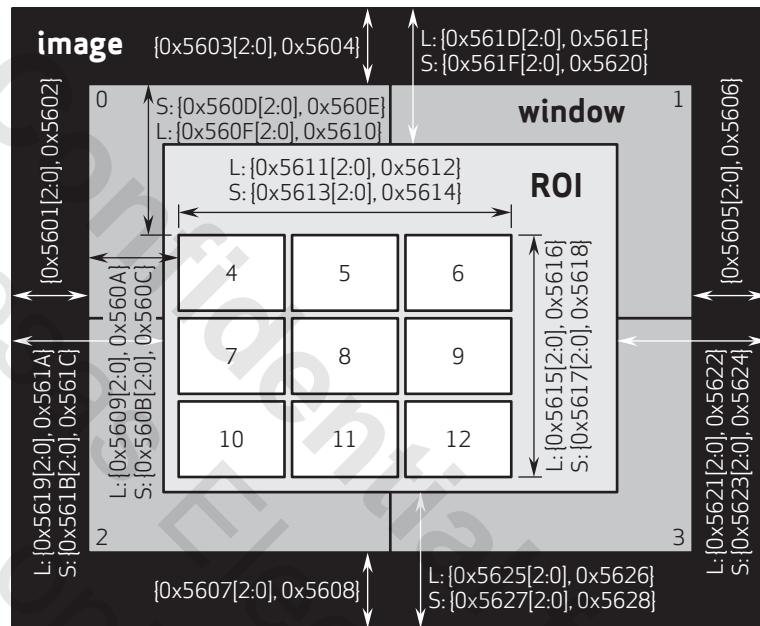

10635_DS_4.7

table 4-4 position window control registers (sheet 1 of 5)

address	register name	default value	R/W	description
0x5600	AEC CTRL00	0x01	RW	Bit[7:2]: Not used Bit[1:0]: Sampling 0x: 2 10: 4 11: 8
0x5601	AEC CTRL01	0x00	RW	Bit[7:3]: Not used Bit[2:0]: Statwinleft[10:8] Horizontal start point of outer 4-zone statistic window

table 4-4 position window control registers (sheet 2 of 5)

address	register name	default value	R/W	description
0x5602	AEC CTRL02	0x00	RW	Bit[7:0]: Statwinleft[7:0] Horizontal start point of outer 4-zone statistic window
0x5603	AEC CTRL03	0x00	RW	Bit[7:2]: Not used Bit[1:0]: Statwintop[9:8] Vertical start point of outer 4-zone statistic window
0x5604	AEC CTRL04	0x00	RW	Bit[7:0]: Statwintop[7:0] Vertical start point for statistic image
0x5605	AEC CTRL05	0x00	RW	Bit[7:3]: Not used Bit[2:0]: Statwinright[10:8] Horizontal end point of outer 4-zone statistic window
0x5606	AEC CTRL06	0x00	RW	Bit[7:0]: Statwinright[7:0] Horizontal end point of outer 4-zone statistic window
0x5607	AEC CTRL07	0x00	RW	Bit[7:2]: Not used Bit[1:0]: Statwinbottom[9:8] Vertical end point of outer 4-zone statistic window
0x5608	AEC CTRL08	0x00	RW	Bit[7:0]: Statwinbottom Vertical end point of outer 4-zone statistic window
0x5609	AEC CTRL09	0x00	RW	Bit[7:3]: Not used Bit[2:0]: winleft_l[10:8] Horizontal start point of inner 9-zone window long exposure sub-pixel
0x560A	AEC CTRL0A	0x64	RW	Bit[7:0]: winleft_l Horizontal start point of inner 9-zone window long exposure sub-pixel
0x560B	AEC CTRL0B	0x00	RW	Bit[7:3]: Not used Bit[2:0]: winleft_s[10:8] Horizontal start point of inner 9-zone window short exposure sub-pixel
0x560C	AEC CTRL0C	0x64	RW	Bit[7:0]: winleft_s[7:0] Horizontal start point of inner 9-zone window short exposure sub-pixel
0x560D	AEC CTRL0D	0x00	RW	Bit[7:2]: Not used Bit[1:0]: wintop_l[9:8] Vertical start point of inner 9-zone window long exposure sub-pixel

table 4-4 position window control registers (sheet 3 of 5)

address	register name	default value	R/W	description
0x560E	AEC CTRL0E	0x4B	RW	Bit[7:0]: wintop_l[7:0] Vertical start point of inner 9-zone window long exposure sub-pixel
0x560F	AEC CTRL0F	0x00	RW	Bit[7:2]: Not used Bit[1:0]: wintop_s[9:8] Vertical start point of inner 9-zone window short exposure sub-pixel
0x5610	AEC CTRL10	0x4B	RW	Bit[7:0]: wintop_s[7:0] Vertical start point of inner 9-zone window short exposure sub-pixel
0x5611	AEC CTRL11	0x00	RW	Bit[7:3]: Not used Bit[2:0]: winwidth_l[10:8] Horizontal width of inner 9-zone window long exposure sub-pixel
0x5612	AEC CTRL12	0xC8	RW	Bit[7:0]: winwidth_l[7:0] Horizontal width of inner 9-zone window long exposure sub-pixel
0x5613	AEC CTRL13	0x00	RW	Bit[7:3]: Not used Bit[2:0]: winwidth_s[10:8] Horizontal width of inner 9-zone window short exposure sub-pixel
0x5614	AEC CTRL14	0xC8	RW	Bit[7:0]: winwidth_s[7:0] Horizontal width of inner 9-zone window short exposure sub-pixel
0x5615	AEC CTRL15	0x00	RW	Bit[7:2]: Not used Bit[1:0]: winheight_l[9:8] Vertical width of inner 9-zone window long exposure sub-pixel
0x5616	AEC CTRL16	0x96	RW	Bit[7:0]: winheight_l[7:0] Vertical width of inner 9-zone window long exposure sub-pixel
0x5617	AEC CTRL17	0x00	RW	Bit[7:2]: Not used Bit[1:0]: winheight_s[9:8] Vertical width of inner 9-zone window long exposure sub-pixel
0x5618	AEC CTRL18	0x96	RW	Bit[7:0]: winheight_s[7:0] Vertical width of inner 9-zone window long exposure sub-pixel
0x5619	AEC CTRL19	0x00	RW	Bit[7:3]: Not used Bit[2:0]: roi_left_l[10:8] Horizontal start point for ROI for long exposure sub-pixel

table 4-4 position window control registers (sheet 4 of 5)

address	register name	default value	R/W	description
0x561A	AEC CTRL1A	0x00	RW	Bit[7:0]: roi_left_l[7:0] Horizontal start point for ROI for long exposure sub-pixel
0x561B	AEC CTRL1B	0x00	RW	Bit[7:3]: Not used Bit[2:0]: roi_left_s[10:8] Horizontal start point for ROI for short exposure sub-pixel
0x561C	AEC CTRL1C	0x00	RW	Bit[7:0]: roi_left_s[7:0] Horizontal start point for ROI for short exposure sub-pixel
0x561D	AEC CTRL1D	0x00	RW	Bit[7:2]: Not used Bit[1:0]: roi_top_l[9:8] Vertical start point for ROI for long exposure sub-pixel
0x561E	AEC CTRL1E	0x00	RW	Bit[7:0]: roi_top_l[7:0] Vertical start point for ROI for long exposure sub-pixel
0x561F	AEC CTRL1F	0x00	RW	Bit[7:2]: Not used Bit[1:0]: roi_top_s[9:8] Vertical start point for ROI for short exposure sub-pixel
0x5620	AEC CTRL20	0x00	RW	Bit[7:0]: roi_top_s[7:0] Vertical start point for ROI for short exposure sub-pixel
0x5621	AEC CTRL21	0x00	RW	Bit[7:3]: Not used Bit[2:0]: roi_right_l[10:8] Horizontal end point for ROI for long exposure sub-pixel
0x5622	AEC CTRL22	0x00	RW	Bit[7:0]: roi_right_l[7:0] Horizontal end point for ROI for long exposure sub-pixel
0x5623	AEC CTRL23	0x00	RW	Bit[7:3]: Not used Bit[2:0]: roi_right_s[10:8] Horizontal end point for ROI for short exposure sub-pixel
0x5624	AEC CTRL24	0x00	RW	Bit[7:0]: roi_right_s[7:0] Horizontal end point for ROI for short exposure sub-pixel
0x5625	AEC CTRL25	0x00	RW	Bit[7:2]: Not used Bit[1:0]: roi_bottom_l[9:8] Vertical end point for ROI for long exposure sub-pixel

table 4-4 position window control registers (sheet 5 of 5)

address	register name	default value	R/W	description
0x5626	AEC CTRL26	0x00	RW	Bit[7:0]: roi_bottom_l[7:0] Vertical end point for ROI for long exposure sub-pixel
0x5627	AEC CTRL27	0x00	RW	Bit[7:2]: Not used Bit[1:0]: roi_bottom_s[9:8] Vertical end point for ROI for short exposure sub-pixel
0x5628	AEC CTRL28	0x00	RW	Bit[7:0]: roi_bottom_s[7:0] Vertical end point for ROI for short exposure sub-pixel
0x5629	AEC CTRL29	0x00	RW	Bit[7:6]: Not used Bit[5:3]: r_roishift_l Bit[2:0]: r_roishift_s

figure 4-8 position weight diagram

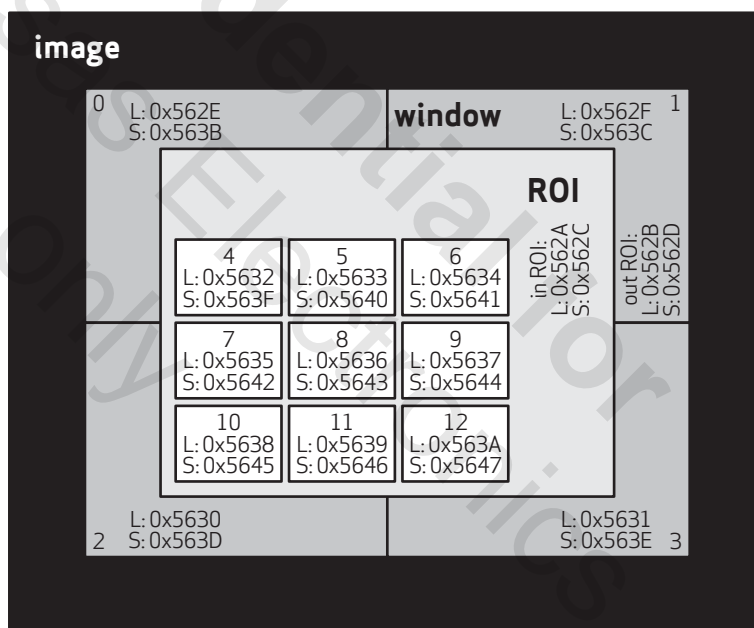

10635_DS_4.8

table 4-5 AEC position weight registers (sheet 1 of 2)

address	register name	default value	R/W	description
0x3621	ANA_ARRAY1	0x03	RW	Bit[4:3]: Horizontal crop mode select 00: Full size 01: Horizontal crop to 768 10: Horizontal crop to 656 11: Not used Bit[2:0]: Analog delay option
0x562A	AEC CTRL2A	0x01	RW	ROIweightl0 for Long Exposure Sub-pixel
0x562B	AEC CTRL2B	0x01	RW	ROIweightl1 for Long Exposure Sub-pixel
0x562C	AEC CTRL2C	0x01	RW	ROIweights0 for Short Exposure Sub-pixel
0x562D	AEC CTRL2D	0x01	RW	ROIweights1 for Short Exposure Sub-pixel
0x562E	AEC CTRL2E	0x01	RW	Weightl0 for Long Exposure Sub-pixel
0x562F	AEC CTRL2F	0x01	RW	Weightl1 for Long Exposure Sub-pixel
0x5630	AEC CTRL30	0x01	RW	Weightl2 for Long Exposure Sub-pixel
0x5631	AEC CTRL31	0x01	RW	Weightl3 for Long Exposure Sub-pixel
0x5632	AEC CTRL32	0x01	RW	Weightl4 for Long Exposure Sub-pixel
0x5633	AEC CTRL33	0x01	RW	Weightl5 for Long Exposure Sub-pixel
0x5634	AEC CTRL34	0x01	RW	Weightl6 for Long Exposure Sub-pixel
0x5635	AEC CTRL35	0x01	RW	Weightl7 for Long Exposure Sub-pixel
0x5636	AEC CTRL36	0x01	RW	Weightl8 for Long Exposure Sub-pixel
0x5637	AEC CTRL37	0x01	RW	Weightl9 for Long Exposure Sub-pixel
0x5638	AEC CTRL38	0x01	RW	Weightla for Long Exposure Sub-pixel
0x5639	AEC CTRL39	0x01	RW	Weightlb for Long Exposure Sub-pixel
0x563A	AEC CTRL3A	0x01	RW	Weightlc for Long Exposure Sub-pixel
0x563B	AEC CTRL3B	0x01	RW	Weights0 for Short Exposure Sub-pixel
0x563C	AEC CTRL3C	0x01	RW	Weights1 for Short Exposure Sub-pixel
0x563D	AEC CTRL3D	0x01	RW	Weights2 for Short Exposure Sub-pixel
0x563E	AEC CTRL3E	0x01	RW	Weights3 for Short Exposure Sub-pixel
0x563F	AEC CTRL3F	0x01	RW	Weights4 for Short Exposure Sub-pixel
0x5640	AEC CTRL40	0x01	RW	Weights5 for Short Exposure Sub-pixel
0x5641	AEC CTRL41	0x01	RW	Weights6 for Short Exposure Sub-pixel
0x5642	AEC CTRL42	0x01	RW	Weights7 for Short Exposure Sub-pixel
0x5643	AEC CTRL43	0x01	RW	Weights8 for Short Exposure Sub-pixel

table 4-5 AEC position weight registers (sheet 2 of 2)

address	register name	default value	R/W	description
0x5644	AEC CTRL44	0x01	RW	Weights9 for Short Exposure Sub-pixel
0x5645	AEC CTRL45	0x01	RW	Weightsa for Short Exposure Sub-pixel
0x5646	AEC CTRL46	0x01	RW	Weightsb for Short Exposure Sub-pixel
0x5647	AEC CTRL47	0x01	RW	Weightsc for Short Exposure Sub-pixel

4.4.2 exposure/gain control

Both long and short exposure are controlled by the same algorithm, which estimates the new exposure based on the weighted average of current frame. Long exposure can change freely in the whole range. Short exposure, however, is limited by the new estimated dynamic range and long exposure.

The AEC/AGC adjustment step is calculated by the distance between current weighted average and the target. When the current weighted average is far from the stable range, the exposure will adjust by big steps to quickly bring the image to stable range. When the current weighted average is close to the stable range, the exposure will adjust by small steps to avoid oscillating.

In the OV10635/OV10135, the exposure time and gain changes every two frames. At the end of first frame, the new exposure time and gain will be estimated and the exposure time registers will be updated afterward. The gain registers will be updated at the end of the second frame. So, the third frame will be the result of new exposure and gain.

figure 4-9 AEC/AGC target/range diagram

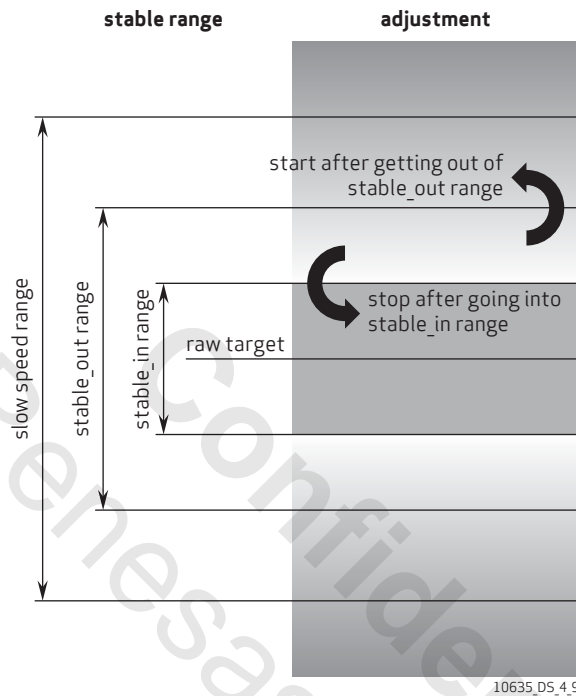

table 4-6 AEC target/range control registers (sheet 1 of 18)

address	register name	default value	R/W	description
0x5648	AEC CTRL48	0x01	RW	Minwl for Long Exposure Sub-pixel
0x5649	AEC CTRL49	0x01	RW	Minws for Short Exposure Sub-pixel
0x564A	AEC CTRL4A	0x00	RW	Bit[7:2]: Not used Bit[1:0]: Maxwl[9:8] for long exposure sub-pixel
0x564B	AEC CTRL4B	0x20	RW	Bit[7:0]: Maxwl[7:0] for long exposure sub-pixel
0x564C	AEC CTRL4C	0x01	RW	Bit[7:2]: Not used Bit[1:0]: Maxws[9:8] for short exposure sub-pixel
0x564D	AEC CTRL4D	0x00	RW	Bit[7:0]: Maxws[7:0] for short exposure sub-pixel
0x566C	AEC CTRL6C	0x00	RW	Bit[0]: his_en

table 4-6 AEC target/range control registers (sheet 2 of 18)

address	register name	default value	R/W	description
0x566D	AEC CTRL6D	0x00	RW	Bit[7:0]: his_addr
0x566E	AEC CTRL6E	–	R	Bit[6:0]: his_data[14:8]
0x566F	AEC CTRL6F	–	R	Bit[7:0]: his_data[7:0]
0x56D0	AEC CTRLD0	0x00	RW	Bit[2:0]: r_man_en
0x56D1	AEC CTRLD1	0x00	RW	Bit[1:0]: cameragain_l_m[9:8]
0x56D2	AEC CTRLD2	0x10	RW	Bit[7:0]: cameragain_l_m[7:0]
0x56D3	AEC CTRLD3	0x00	RW	Bit[1:0]: cameragain_s_m[9:8]
0x56D4	AEC CTRLD4	0x10	RW	Bit[7:0]: cameragain_s_m[7:0]
0x56D5	AEC CTRLD5	0x00	RW	Bit[7:0]: exp_l_m[31:24]
0x56D6	AEC CTRLD6	0x00	RW	Bit[7:0]: exp_l_m[23:16]
0x56D7	AEC CTRLD7	0x00	RW	Bit[7:0]: exp_l_m[15:8]
0x56D8	AEC CTRLD8	0x00	RW	Bit[7:0]: exp_l_m[7:0]
0x56D9	AEC CTRLD9	0x00	RW	Bit[7:0]: exp_s_m[31:24]
0x56DA	AEC CTRLDA	0x00	RW	Bit[7:0]: exp_s_m[23:16]
0x56DB	AEC CTRLDB	0x00	RW	Bit[7:0]: exp_s_m[15:8]
0x56DC	AEC CTRLDC	0x00	RW	Bit[7:0]: exp_s_m[7:0]
0x56DF	AEC CTRLDF	0x02	RW	Bit[2:0]: digigain_l_m[10:8]
0x56E0	AEC CTRL E0	0x00	RW	Bit[7:0]: digigain_l_m[7:0]
0x56E1	AEC CTRL E1	0x02	RW	Bit[2:0]: digigain_s_m[10:8]
0x56E2	AEC CTRL E2	0x00	RW	Bit[7:0]: digigain_s_m[7:0]
0x56E3	AEC CTRL E3	0x00	RW	Bit[0]: exp_ctrl
0x56E4	AEC CTRL E4	0x00	RW	Bit[3:0]: exp_l_f[11:8]
0x56E5	AEC CTRL E5	0x00	RW	Bit[7:0]: exp_l_f[7:0]
0x56E6	AEC CTRL E6	0x00	RW	Bit[7:4]: Not used Bit[3:0]: exp_s_f[11:8]
0x56E7	AEC CTRL E7	0x00	RW	Bit[7:0]: exp_s_f[7:0]
0x56E8	AEC CTRL E8	0x00	RW	Bit[7:1]: Not used Bit[0]: snrgain_l_m[8]
0x56E9	AEC CTRL E9	0x00	RW	Bit[7:0]: snrgain_l_m[7:0]

table 4-6 AEC target/range control registers (sheet 3 of 18)

address	register name	default value	R/W	description
0x56EA	AEC CTRLA	0x00	RW	Bit[7:1]: Not used Bit[0]: snrgain_s_m[8]
0x56EB	AEC CTRLB	0x00	RW	Bit[7:0]: snrgain_s_m[7:0]
0xC2ED	NON-HDR MODE AT HIGH TEMPERATURES	0x00	RW	Bit[7:1]: Not used Bit[0]: Non-HDR mode at high temperatures Set to 0 if HDR mode is on. Set to 1 if non-HDR mode is on. This register value will be automatically initialized by sensor after powering up.
0xC2F0	S_MANUAL_EXP11	–	RW	Bit[7:0]: manual_expo11[15:8] This register value will be automatically initialized by sensor after powering up. Default value is random.
0xC2F1	S_MANUAL_EXP11	–	RW	Bit[7:0]: manual_expo11[7:0] This register value will be automatically initialized by sensor after powering up. Default value is random.
0xC2F2	S_MANUAL_EXP12	–	RW	Bit[7:0]: manual_expo12[15:8] This register value will be automatically initialized by sensor after powering up. Default value is random.
0xC2F3	S_MANUAL_EXP12	–	RW	Bit[7:0]: manual_expo12[7:0] This register value will be automatically initialized by sensor after powering up. Default value is random.
0xC2F4	S_MANUAL_EXP21	–	RW	Bit[7:0]: manual_expo21[15:8] This register value will be automatically initialized by sensor after powering up. Default value is random.
0xC2F5	S_MANUAL_EXP21	–	RW	Bit[7:0]: manual_expo21[7:0] This register value will be automatically initialized by sensor after powering up. Default value is random.

table 4-6 AEC target/range control registers (sheet 4 of 18)

address	register name	default value	R/W	description
0xC2F6	S_MANUAL_EXP22	–	RW	Bit[7:0]: manual_expo22[15:8] This register value will be automatically initialized by sensor after powering up. Default value is random.
0xC2F7	S_MANUAL_EXP22	–	RW	Bit[7:0]: manual_expo22[7:0] This register value will be automatically initialized by sensor after powering up. Default value is random.
0xC2F8	S_MANUAL_EXP31	0x34	RW	Bit[7:0]: manual_expo31[15:8] This register value will be automatically initialized by sensor after powering up. Default value is random.
0xC2F9	S_MANUAL_EXP31	–	RW	Bit[7:0]: manual_expo31[7:0] This register value will be automatically initialized by sensor after powering up. Default value is random.
0xC2FA	S_MANUAL_EXP32	–	RW	Bit[7:0]: manual_expo32[15:0] This register value will be automatically initialized by sensor after powering up. Default value is random.
0xC2FB	S_MANUAL_EXP22	–	RW	Bit[7:0]: manual_expo32[7:0] This register value will be automatically initialized by sensor after powering up. Default value is random.
0xC2FC	S_MANUAL_GAIN11	–	RW	Bit[7:0]: manual_gain11[15:8] This register value will be automatically initialized by sensor after powering up. Default value is random.
0xC2FD	S_MANUAL_GAIN11	–	RW	Bit[7:0]: manual_gain11[7:0] This register value will be automatically initialized by sensor after powering up. Default value is random.
0xC2FE	S_MANUAL_GAIN12	–	RW	Bit[7:0]: manual_gain12[15:8] This register value will be automatically initialized by sensor after powering up. Default value is random.

table 4-6 AEC target/range control registers (sheet 5 of 18)

address	register name	default value	R/W	description
0xC2FF	S_MANUAL_GAIN12	–	RW	Bit[7:0]: manual_gain12[7:0] This register value will be automatically initialized by sensor after powering up. Default value is random.
0xC300	S_MANUAL_GAIN21	–	RW	Bit[7:0]: manual_gain21[15:8] This register value will be automatically initialized by sensor after powering up. Default value is random.
0xC301	S_MANUAL_GAIN21	–	RW	Bit[7:0]: manual_gain21[7:0] This register value will be automatically initialized by sensor after powering up. Default value is random.
0xC302	S_MANUAL_GAIN22	–	RW	Bit[7:0]: manual_gain22[15:8] This register value will be automatically initialized by sensor after powering up. Default value is random.
0xC303	S_MANUAL_GAIN22	–	RW	Bit[7:0]: manual_gain22[7:0] This register value will be automatically initialized by sensor after powering up. Default value is random.
0xC304	S_MANUAL_GAIN31	–	RW	Bit[7:0]: manual_gain31[15:8] This register value will be automatically initialized by sensor after powering up. Default value is random.
0xC305	S_MANUAL_GAIN31	–	RW	Bit[7:0]: manual_gain31[7:0] This register value will be automatically initialized by sensor after powering up. Default value is random.
0xC306	S_MANUAL_GAIN32	–	RW	Bit[7:0]: manual_gain32[15:8] This register value will be automatically initialized by sensor after powering up. Default value is random.
0xC307	S_MANUAL_GAIN32	–	RW	Bit[7:0]: manual_gain32[7:0] This register value will be automatically initialized by sensor after powering up. Default value is random.

table 4-6 AEC target/range control registers (sheet 6 of 18)

address	register name	default value	R/W	description
0xC308	S_MANUAL_EN	–	RW	<p>Bit[7:1]: Not used Bit[0]: manual_en 0: Disable 1: Enable</p> <p>When register value is 0x00, it means function is disabled; all other values mean function is enabled. This register value must be initialized by user and must not be removed from start up sequence. Default value is random.</p>
0xC309	S_MANUAL_MODE	–	RW	<p>Bit[7:3]: Not used Bit[2]: targetc_manual_en 0: Disable 1: Enable Bit[1]: targetb_manual_en 0: Disable 1: Enable Bit[0]: targeta_manual_en 0: Disable 1: Enable</p> <p>This register value must be initialized by user and must not be removed from start up sequence. Default value is random.</p>
0xC30A	S_MANUAL_DONE	–	RW	<p>Bit[7:2]: Not used Bit[1:0]: manual_done 00: Write protected 01: Write valid once 10: Write valid always</p> <p>This register value must be initialized by user and must not be removed from start up sequence. Default value is random.</p>
0xC450	TARGET_NUM	–	RW	<p>Bit[7:2]: Not used Bit[1:0]: Target number 01: AA mode 10: AB mode 11: ABC mode</p> <p>This register value must be initialized by user and must not be removed from start up sequence. Default value is random.</p>
0xC452	LS_SENS_RATIO_1	–	RW	<p>Bit[7:0]: L/S sensitivity ratio[15:8]</p> <p>This register value must be initialized by user and must not be removed from start up sequence. Default value is random.</p>

table 4-6 AEC target/range control registers (sheet 7 of 18)

address	register name	default value	R/W	description
0xC453	LS_SENS_RATIO_2	–	RW	<p>Bit[7:0]: L/S sensitivity ratio[7:0]</p> <p>This register value must be initialized by user and must not be removed from start up sequence. Default value is random.</p>
0xC454	NONHDR_EN	–	RW	<p>Bit[7:1]: Not used Bit[0]: Non-HDR mode 0: Disable 1: Enable</p> <p>When register value is 0x00, it means function is disabled; all other values mean function is enabled. This register value must be initialized by user and must not be removed from start up sequence. Default value is random.</p>
0xC456	FIXED_RATIO_EN	–	RW	<p>Bit[7:1]: Not used Bit[0]: Fixed ratio mode 0: Disable 1: Enable</p> <p>When register value is 0x00, it means function is disabled; all other values mean function is enabled. This register value must be initialized by user and must not be removed from start up sequence. Default value is random.</p>
0xC457	GP_MODE_EN	–	RW	<p>Bit[7:1]: Not used Bit[0]: Geometric proportion mode 0: Disable 1: Enable</p> <p>When register value is 0x00, it means function is disabled; all other values mean function is enabled. This register value must be initialized by user and must not be removed from start up sequence. Default value is random.</p>
0xC458	NIGHT_MODE_EN	–	RW	<p>Bit[7:1]: Not used Bit[0]: Night mode 0: Disable 1: Enable</p> <p>When register value is 0x00, it means function is disabled; all other values mean function is enabled. This register value must be initialized by user and must not be removed from start up sequence. Default value is random.</p>

table 4-6 AEC target/range control registers (sheet 8 of 18)

address	register name	default value	R/W	description
0xC459	NIGHT_MODE_CTRL	–	RW	<p>Bit[7:1]: Not used Bit[0]: Only insert frame when in night mode 0: Disable 1: Enable</p> <p>When register value is 0x00, it means function is disabled; all other values mean function is enabled. This register value must be initialized by user and must not be removed from start up sequence. Default value is random.</p>
0xC45A	FRACTAL_EXP_EN	–	RW	<p>Bit[7:1]: Not used Bit[0]: Allow fractal exposure 0: Disable 1: Enable</p> <p>When register value is 0x00, it means function is disabled; all other values mean function is enabled. This register value will be automatically initialized by sensor after powering up. Default value is random.</p>
0xC45B	NONLINEAR_GAIN_EN	–	RW	<p>Bit[7:1]: Not used Bit[0]: Debug only</p> <p>This register value must be initialized by user and must not be removed from start up sequence. Default value is random.</p>
0xC45C	MANU_GAMMA_EN	–	RW	<p>Bit[7:1]: Not used Bit[0]: Manual gamma mode 0: Disable 1: Enable</p> <p>When register value is 0x00, it means function is disabled; all other values mean function is enabled. This register value must be initialized by user and must not be removed from start up sequence. Default value is random.</p>
0xC45E	BAND_FILTER_FLAG	–	RW	<p>Bit[7:2]: Not used Bit[1:0]: Light source type 00: Frequency is zero or very high 01: 60Hz 10: 50Hz 11: Not valid</p> <p>This register value must be initialized by user and must not be removed from start up sequence. Default value is random.</p>

table 4-6 AEC target/range control registers (sheet 9 of 18)

address	register name	default value	R/W	description
0xC45F	BAND_FILTER_EN	–	RW	<p>Bit[7:1]: Not used Bit[0]: Banding filter 0: Disable 1: Enable</p> <p>When register value is 0x00, it means function is disabled; all other values mean function is enabled. This register value must be initialized by user and must not be removed from start up sequence. Default value is random.</p>
0xC460	BAND_FILTER_SHORT	–	RW	<p>Bit[7:1]: Not used Bit[0]: Short banding filter 0: Disable 1: Enable</p> <p>When register value is 0x00, it means function is disabled; all other values mean function is enabled. This register value must be initialized by user and must not be removed from start up sequence. Default value is random.</p>
0xC461	LESS_1BAND_EN	–	RW	<p>Bit[7:1]: Not used Bit[0]: Less than one band exposure mode 0: Disable 1: Enable</p> <p>When register value is 0x00, it means function is disabled; all other values mean function is enabled. This register value must be initialized by user and must not be removed from start up sequence. Default value is random.</p>
0xC462	LESS_1BAND_SHORT	–	RW	<p>Bit[7:1]: Not used Bit[0]: Less than one band exposure for short 0: Disable 1: Enable</p> <p>When register value is 0x00, it means function is disabled; all other values mean function is enabled. This register value must be initialized by user and must not be removed from start up sequence. Default value is random.</p>
0xC464	LOG_TARGET_11	–	RW	<p>Bit[7:0]: Log target 1[15:8]</p> <p>This register value must be initialized by user and must not be removed from start up sequence. Default value is random.</p>

table 4-6 AEC target/range control registers (sheet 10 of 18)

address	register name	default value	R/W	description
				Bit[7:0]: Log target 1[7:0]
0xC465	LOG_TARGET_12	–	RW	This register value must be initialized by user and must not be removed from start up sequence. Default value is random.
				Bit[7:0]: Log target 2[15:8]
0xC466	LOG_TARGET_21	–	RW	This register value must be initialized by user and must not be removed from start up sequence. Default value is random.
				Bit[7:0]: Log target 2[7:0]
0xC467	LOG_TARGET_22	–	RW	This register value must be initialized by user and must not be removed from start up sequence. Default value is random.
				Bit[7:0]: Log target 3[15:8]
0xC468	LOG_TARGET_31	–	RW	This register value must be initialized by user and must not be removed from start up sequence. Default value is random.
				Bit[7:0]: Log target 3[7:0]
0xC469	LOG_TARGET_32	–	RW	This register value must be initialized by user and must not be removed from start up sequence. Default value is random.
				Target of Raw Data for Long 1
0xC46A	TARGET_LONG_1	–	RW	This register value must be initialized by user and must not be removed from start up sequence. Default value is random.
				Target of Raw Data for Long 2
0xC46B	TARGET_LONG_2	–	RW	This register value must be initialized by user and must not be removed from start up sequence. Default value is random.
				Target of Raw Data for Long 3
0xC46C	TARGET_LONG_3	–	RW	This register value must be initialized by user and must not be removed from start up sequence. Default value is random.
				Target of Raw Data for Short 1
0xC46D	TARGET_SHORT_1	–	RW	This register value must be initialized by user and must not be removed from start up sequence. Default value is random.

table 4-6 AEC target/range control registers (sheet 11 of 18)

address	register name	default value	R/W	description
0xC46E	TARGET_SHORT_2	–	RW	Target of Raw Data for Short 2 This register value must be initialized by user and must not be removed from start up sequence. Default value is random.
0xC46F	TARGET_SHORT_3	–	RW	Target of Raw Data for Short 3 This register value must be initialized by user and must not be removed from start up sequence. Default value is random.
0xC470	SLOW_RANGE_LONG	–	RW	Slow Range for Long Exposure This register value will be automatically initialized by sensor after powering up. Default value is random.
0xC471	SLOW_RANGE_SHORT	–	RW	Slow Range for Short Exposure This register value will be automatically initialized by sensor after powering up. Default value is random.
0xC472	STABLE_RANGE_IN	–	RW	Range Become Stable from Unstable This register value will be automatically initialized by sensor after powering up. Default value is random.
0xC473	STABLE_RANGE_OUT	–	RW	Range Become Unstable from Stable This register value will be automatically initialized by sensor after powering up. Default value is random.
0xC474	FAST_STEP_LONG	–	RW	Fast AEC Adjustment Step for Long Exposure This register value will be automatically initialized by sensor after powering up. Default value is random.
0xC475	FAST_STEP_SHORT	–	RW	Fast AEC Adjustment Step for Short Exposure This register value will be automatically initialized by sensor after powering up. Default value is random.
0xC476	SLOW_STEP_LONG	–	RW	Slow AEC Adjustment Step for Long Exposure This register value will be automatically initialized by sensor after powering up. Default value is random.

table 4-6 AEC target/range control registers (sheet 12 of 18)

address	register name	default value	R/W	description
0xC477	SLOW_STEP_SHORT	–	RW	Slow AEC Adjustment Step for Short Exposure This register value will be automatically initialized by sensor after powering up. Default value is random.
0xC478	MAX_FAST_RATIO	–	RW	Max Fast Adjustment Ratio This register value will be automatically initialized by sensor after powering up. Default value is random.
0xC479	MAX_SLOW_RATIO	–	RW	Max Slow Adjustment Ratio This register value will be automatically initialized by sensor after powering up. Default value is random.
0xC47C	MAX_SHORT_LE_1	–	RW	Bit[7:0]: Max short light exposure[31:24] This register value must be initialized by user and must not be removed from start up sequence. Default value is random.
0xC47D	MAX_SHORT_LE_2	–	RW	Bit[7:0]: Max short light exposure[23:16] This register value must be initialized by user and must not be removed from start up sequence. Default value is random.
0xC47E	MAX_SHORT_LE_3	–	RW	Bit[7:0]: Max short light exposure[15:8] This register value must be initialized by user and must not be removed from start up sequence. Default value is random.
0xC47F	MAX_SHORT_LE_4	–	RW	Bit[7:0]: Max short light exposure[7:0] This register value must be initialized by user and must not be removed from start up sequence. Default value is random.
0xC480	MAX_GAIN_LONG_1	–	RW	Bit[7:2]: Not used Bit[1:0]: Max gain for long[9:8] This register value must be initialized by user and must not be removed from start up sequence. Default value is random.

table 4-6 AEC target/range control registers (sheet 13 of 18)

address	register name	default value	R/W	description
0xC481	MAX_GAIN_LONG_2	–	RW	Bit[7:0]: Max gain for long[7:0] This register value must be initialized by user and must not be removed from start up sequence. Default value is random.
0xC482	MAX_GAIN_SHORT_1	–	RW	Bit[7:2]: Not used Bit[1:0]: Max gain for short[9:8] This register value must be initialized by user and must not be removed from start up sequence. Default value is random.
0xC483	MAX_GAIN_SHORT_1	–	RW	Bit[7:0]: Max gain for short[7:0] This register value must be initialized by user and must not be removed from start up sequence. Default value is random.
0xC484	MIN_GAIN_LONG_1	–	RW	Bit[7:2]: Not used Bit[1:0]: Min gain for long[9:8] This register value must be initialized by user and must not be removed from start up sequence. Default value is random.
0xC485	MIN_GAIN_LONG_2	–	RW	Bit[7:0]: Min gain for long[7:0] This register value must be initialized by user and must not be removed from start up sequence. Default value is random.
0xC486	MIN_GAIN_SHORT_1	–	RW	Bit[7:2]: Not used Bit[1:0]: Min gain for short[9:8] This register value must be initialized by user and must not be removed from start up sequence. Default value is random.
0xC487	MIN_GAIN_SHORT_2	–	RW	Bit[7:0]: Min gain for short[7:0] This register value must be initialized by user and must not be removed from start up sequence. Default value is random.
0xC488	MAX_EXP_LONG_1	–	RW	Bit[7:0]: Max exposure for long[15:8] This register value must be initialized by user and must not be removed from start up sequence. Default value is random.

table 4-6 AEC target/range control registers (sheet 14 of 18)

address	register name	default value	R/W	description
0xC489	MAX_EXP_LONG_2	–	RW	Bit[7:0]: Max exposure for long[7:0] This register value must be initialized by user and must not be removed from start up sequence. Default value is random.
0xC48A	MAX_EXP_SHORT_1	–	RW	Bit[7:0]: Max exposure for short[15:8] This register value must be initialized by user and must not be removed from start up sequence. Default value is random.
0xC48B	MAX_EXP_SHORT_2	–	RW	Bit[7:0]: Max exposure for short[7:0] This register value must be initialized by user and must not be removed from start up sequence. Default value is random.
0xC48C	MIN_EXP_LONG_1	–	RW	Bit[7:0]: Min exposure for long[15:8] This register value must be initialized by user and must not be removed from start up sequence. Default value is random.
0xC48D	MIN_EXP_LONG_2	–	RW	Bit[7:0]: Min exposure for long[7:0] This register value must be initialized by user and must not be removed from start up sequence. Default value is random.
0xC48E	MIN_EXP_SHORT_1	–	RW	Bit[7:0]: Min exposure for short[15:8] This register value must be initialized by user and must not be removed from start up sequence. Default value is random.
0xC48F	MIN_EXP_SHORT_2	–	RW	Bit[7:0]: Min exposure for short[7:0] This register value must be initialized by user and must not be removed from start up sequence. Default value is random.
0xC490	FIXED_RATIO	–	RW	Fixed Ratio, Value+1 This register value must be initialized by user and must not be removed from start up sequence. Default value is random.
0xC492	GP_MODE_RATIO_B2A	–	RW	B/A Ratio in Gp Mode This register value must be initialized by user and must not be removed from start up sequence. Default value is random.

table 4-6 AEC target/range control registers (sheet 15 of 18)

address	register name	default value	R/W	description
				C/A Ratio in Gp Mode
0xC493	GP_MODE_RATIO_C2A	–	RW	This register value must be initialized by user and must not be removed from start up sequence. Default value is random.
				Bit[7:0]: Min gamma list 1[15:8]
0xC498	MIN_GAMMA_LIST_11	–	RW	This register value must be initialized by user and must not be removed from start up sequence. Default value is random.
				Bit[7:0]: Min gamma list 1[7:0]
0xC499	MIN_GAMMA_LIST_12	–	RW	This register value must be initialized by user and must not be removed from start up sequence. Default value is random.
				Bit[7:0]: Min gamma list 2[15:8]
0xC49A	MIN_GAMMA_LIST_21	–	RW	This register value must be initialized by user and must not be removed from start up sequence. Default value is random.
				Bit[7:0]: Min gamma list 2[7:0]
0xC49B	MIN_GAMMA_LIST_22	–	RW	This register value must be initialized by user and must not be removed from start up sequence. Default value is random.
				Bit[7:0]: Min gamma list 3[15:8]
0xC49C	MIN_GAMMA_LIST_31	–	RW	This register value must be initialized by user and must not be removed from start up sequence. Default value is random.
				Bit[7:0]: Min gamma list 3[7:0]
0xC49D	MIN_GAMMA_LIST_32	–	RW	This register value must be initialized by user and must not be removed from start up sequence. Default value is random.
				Bit[7:0]: Max gamma list 1[15:8]
0xC49E	MAX_GAMMA_LIST_11	–	RW	This register value must be initialized by user and must not be removed from start up sequence. Default value is random.
				Bit[7:0]: Max gamma list 1[7:0]
0xC49F	MAX_GAMMA_LIST_12	–	RW	This register value must be initialized by user and must not be removed from start up sequence. Default value is random.

table 4-6 AEC target/range control registers (sheet 16 of 18)

address	register name	default value	R/W	description
0xC4A0	MAX_GAMMA_LIST_21	–	RW	Bit[7:0]: Max gamma list 2[15:8] This register value must be initialized by user and must not be removed from start up sequence. Default value is random.
0xC4A1	MAX_GAMMA_LIST_22	–	RW	Bit[7:0]: Max gamma list 2[7:0] This register value must be initialized by user and must not be removed from start up sequence. Default value is random.
0xC4A2	MAX_GAMMA_LIST_31	–	RW	Bit[7:0]: Max gamma list 3[15:8] This register value must be initialized by user and must not be removed from start up sequence. Default value is random.
0xC4A3	MAX_GAMMA_LIST_32	–	RW	Bit[7:0]: Max gamma list 3[7:0] This register value must be initialized by user and must not be removed from start up sequence. Default value is random.
0xC4A4	DR_LIST_11	–	RW	Bit[7:0]: Dynamic range list 1[15:8] This register value must be initialized by user and must not be removed from start up sequence. Default value is random.
0xC4A5	DR_LIST_12	–	RW	Bit[7:0]: Dynamic range list 1[7:0] This register value must be initialized by user and must not be removed from start up sequence. Default value is random.
0xC4A6	DR_LIST_21	–	RW	Bit[7:0]: Dynamic range list 2[15:8] This register value must be initialized by user and must not be removed from start up sequence. Default value is random.
0xC4A7	DR_LIST_22	–	RW	Bit[7:0]: Dynamic range list 2[7:0] This register value must be initialized by user and must not be removed from start up sequence. Default value is random.
0xC4A8	DR_LIST_31	–	RW	Bit[7:0]: Dynamic range list 3[15:8] This register value must be initialized by user and must not be removed from start up sequence. Default value is random.

table 4-6 AEC target/range control registers (sheet 17 of 18)

address	register name	default value	R/W	description
0xC4A9	DR_LIST_32	–	RW	Bit[7:0]: Dynamic range list 3[7:0] This register value must be initialized by user and must not be removed from start up sequence. Default value is random.
0xC4AA	BAND_VALUE_60HZ_1	–	RW	Bit[7:0]: Band filter value for 60Hz[15:8] This register value must be initialized by user and must not be removed from start up sequence. Default value is random.
0xC4AB	BAND_VALUE_60HZ_2	–	RW	Bit[7:0]: Band filter value for 60Hz[7:0] This register value must be initialized by user and must not be removed from start up sequence. Default value is random.
0xC4AC	BAND_VALUE_50HZ_1	–	RW	Bit[7:0]: Band filter value for 50Hz[15:8] This register value must be initialized by user and must not be removed from start up sequence. Default value is random.
0xC4AD	BAND_VALUE_50HZ_2	–	RW	Bit[7:0]: Band filter value for 50Hz[7:0] This register value must be initialized by user and must not be removed from start up sequence. Default value is random.
0xC4B1	MIN_DR_RATIO	–	RW	Min Dynamic Ratio This register value will be automatically initialized by sensor after powering up. Default value is random.
0xC4B2	MAX_DR_RATIO_1	–	RW	Bit[7:0]: Max dynamic ratio[15:8] This register value will be automatically initialized by sensor after powering up. Default value is random.
0xC4B3	MAX_DR_RATIO_2	–	RW	Bit[7:0]: Max dynamic ratio[7:0] This register value will be automatically initialized by sensor after powering up. Default value is random.
0xC514	SENSOR_CLK_RATIO_1	–	RW	Bit[7:0]: Sensor clock ratio[15:8] This register value must be initialized by user and must not be removed from start up sequence. Default value is random.

table 4-6 AEC target/range control registers (sheet 18 of 18)

address	register name	default value	R/W	description
0xC515	SENSOR_CLK_RATIO_2	–	RW	Bit[7:0]: Sensor clock ratio[7:0] This register value must be initialized by user and must not be removed from start up sequence. Default value is random.
0xC518	VTS_ADDR_1	–	RW	Bit[7:0]: VTS[15:8] This register value must be initialized by user and must not be removed from start up sequence. Default value is random.
0xC519	VTS_ADDR_2	–	RW	Bit[7:0]: VTS[7:0] This register value must be initialized by user and must not be removed from start up sequence. Default value is random.
0x5A00~ 0x5C17	AEC_R	–	R	Debug Information for AEC Control

Renesas Confidential for
only
Electronics

4.5 black level calibration (BLC)

In order to maximize the ADC range, and thus, the SNR, the OV10635/OV10135 compensates for the black level of active pixels by using optically shielded pixels. There are coarse and fine BLC calibrations that, when used together, can compensate for very large offsets with a high degree of accuracy.

4.5.1 coarse and fine BLC

Dark current changes with temperature. At very high temperature, the dark current level may be out of the fine BLC range. The coarse BLC cancels the majority of the dark current to make sure the remaining dark current is within the range of the fine BLC compensation. The fine BLC then performs the final subtraction of the optically black pixels from the active pixels.

4.5.2 trigger methods

Coarse BLC and fine BLC are initiated by any of the following conditions:

- image sensor soft or hard reset
- changes in either gain or exposure
- change in temperature
- change in data output format

BLC can also be manually triggered by setting the register 0x4003[7] from 0 to 1.

table 4-7 BLC control functions (sheet 1 of 3)

address	register name	default value	R/W	description
0x4000	BLC CTRL00	0x09	RW	Bit[7:4]: Not used Bit[3:1]: Chip debug Bit[0]: BLC enable 0: Disable 1: Enable
0x4001	START LINE	0x04	RW	Bit[7:5]: Not used Bit[4:0]: Start line Start line for calculating normal offsets
0x4002	BLC CTRL02	0xC5	RW	Bit[7]: Trigger BLC when format changes 0: Change of format will not trigger BLC 1: Change of format will trigger BLC Bit[6]: BLC manual mode enable 0: Use manual offsets for BLC 1: Use calculated offsets for BLC Bit[5:0]: rest_frame_num Number indicates how many frames BLC will be updated continuously when BLC is reset

table 4-7 BLC control functions (sheet 2 of 3)

address	register name	default value	R/W	description
0x4003	BLC CTRL03	0x08	RW	Bit[7]: BLC manual trigger BLC will update manual_frame_num frames continuously. Refer to register BLC CTRL03[5:0] when this register changes from 0 to 1 Bit[6]: BLC freeze 0: BLC running 1: BLC freeze Bit[5:0]: manual_frame_num Number of frames BLC will be updated continuously when BLC is manually triggered by register BLC CTRL03[7]
0x4004	LINE NUM	0x08	RW	Bit[7:5]: Not used Bit[4:0]: line_num Line number specifies black lines used in offsets calculation
0x4008	LONG BLC TARGET	–	R	Bit[7:0]: Target black level for long exposure channel BLC target for long exposure channel
0x4009	SHORT BLC TARGET	–	R	Bit[7:0]: Target black level for short exposure channel BLC target for short exposure channel
0x4050~ 0x4051	BLC CTRL5	–	RW	BLC Control Changing these registers is not allowed

table 4-7 BLC control functions (sheet 3 of 3)

address	register name	default value	R/W	description
0x4055	BLC CTRL55	0xFF	RW	Bit[7]: Debug control Changing this value is not allowed
				Bit[6]: BLC temperature trigger enable for short exposure channel 0: Temperature change does not trigger BLC 1: Temperature change triggers BLC
				Bit[5]: BLC exposure trigger enable for short exposure channel 0: Exposure change does not trigger BLC 1: Exposure change triggers BLC
				Bit[4]: BLC gain trigger enable for short exposure channel 0: Gain change does not trigger BLC 1: Gain change triggers BLC
				Bit[3]: Debug control Changing this value is not allowed
				Bit[2]: BLC temperature trigger enable for long exposure channel 0: Temperature change does not trigger BLC 1: Temperature change triggers BLC
				Bit[1]: BLC exposure trigger enable for long exposure channel 0: Exposure change does not trigger BLC 1: Exposure change triggers BLC
				Bit[0]: BLC gain trigger enable for long exposure channel 0: Gain change does not trigger BLC 1: Gain change triggers BLC

Confidential for
Renesas Electronics
only

5 image sensor processor digital functions

5.1 DSP top level control

The DSP top level control registers allow enabling and disabling of individual DSP blocks. However, the user must be very careful as each image format requires specific blocks. Provided reference settings should always be used as a guideline.

table 5-1 DSP top registers (sheet 1 of 2)

address	register name	default value	R/W	description
0x5000	ISP RW00	0xFF	RW	Bit[7]: Color matrix enable Bit[6]: Color interpolation enable Bit[5]: Denoise enable Bit[4]: white defect pixel correction enable Bit[3]: Black defect pixel correction enable Bit[2]: AWB statistic enable Bit[1]: AWB gain enable Bit[0]: Lens shading correction enable
0x5001	ISP RW01	0xBF	RW	Bit[7]: Data and its weight synchronization enable Bit[6]: Black/white mode enable Bit[5]: Dark level filter enable Bit[4]: Buffer control enable Bit[3]: AEC enable Bit[2]: Tone mapping enable Bit[1]: Normalize enable Bit[0]: Long-short combination enable
0x5002	ISP RW02	0x7E	RW	Bit[7]: OTP manual offset enable Bit[6]: OTP function enable Bit[5]: Inter frame calculation Bit[4]: CT AWB function enable Bit[3]: Digital gain enable Bit[2]: Window border cut enable Bit[1]: Dithering enable Bit[0]: Chip debug
0x5004	ISP RW04	0x14	RW	Bit[7:5]: Not used Bit[4]: Auto window enable 0: Manually set image window for DSP blocks 1: Automatically handle image window Bit[3]: Not used Bit[2:0]: Dummy line number for ISP

table 5-1 DSP top registers (sheet 2 of 2)

address	register name	default value	R/W	description
0x5005	ISP RW05	0x08	RW	Bit[7]: Vertical subsampling enable 0: Disable 1: Enable Bit[6]: Lens shading correction center option 0: Manually set by register 1: Automatically set based on image window Bit[5]: Output row in drop mode of subsampling 0: First row 1: Second row Bit[4]: Output column in drop mode of subsampling 0: First pair 1: Second pair Bit[3]: Average enable in non-drop mode of subsampling 0: Sum 1: Average Bit[2]: Green/Y channel subsampling mode 0: Non-drop 1: Drop Bit[1]: RB/UV channel subsampling mode 0: Non-drop 1: Drop Bit[0]: Subsampling mode enable 0: Full resolution 1: Subsampling

Renesas Confidential for
only Electronics

5.2 LENC

The lens correction (LENC) algorithm compensates for the illumination drop off in the corners due to the lens. Based on the radius of each pixel to the lens, the algorithm calculates a gain for each pixel and then corrects each pixel with the calculated gain to compensate for the light distribution due to the lens curvature.

The LENC register settings are calculated from a lens correction tool developed by OmniVision and run with the specific lens used on the application.

figure 5-1 LENC coefficient versus sensor gain

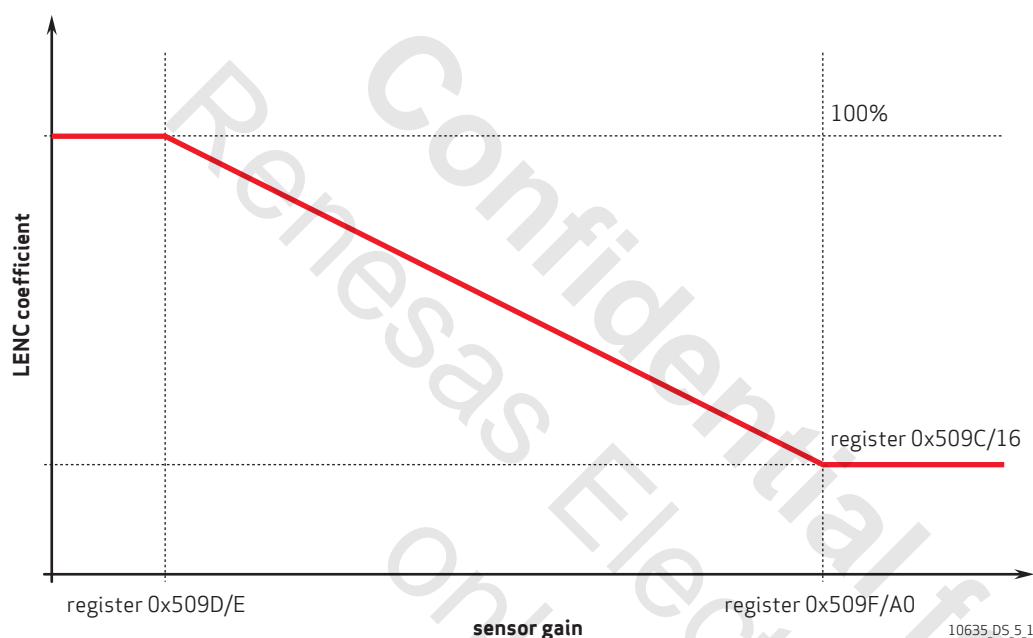

LENC gain is fixed by default. Register 0x5080[5] turns on the gain adaptive LENC.

table 5-2 LENC control registers (sheet 1 of 4)

address	register name	default value	R/W	description
0x5080	LENC CTRL0	0x10	RW	Bit[7]: Not used Bit[6]: Gain manual mode enable 0: Use auto gain 1: Use manual gain set by user Bit[5]: Auto LENC switch enable 0: LENC gain is fixed 1: LENC gain adjusts according to sensor gain Bit[4:0]: Manual gain input

table 5-2 LENC control registers (sheet 2 of 4)

address	register name	default value	R/W	description
0x5081	LENC CTRL1	0x00	RW	Bit[7:3]: Not used Bit[2:0]: long_red_x0[10:8]
0x5082	LENC CTRL2	0x00	RW	Bit[7:0]: long_red_x0[7:0]
0x5083	LENC CTRL3	0x00	RW	Bit[7:2]: Not used Bit[1:0]: long_red_y0[9:8]
0x5084	LENC CTRL4	0x00	RW	Bit[7:0]: long_red_y0[7:0]
0x5085	LENC CTRL5	0x00	RW	Bit[7]: Not used Bit[6:0]: long_red_a1
0x5086	LENC CTRL6	0x01	RW	Bit[7:4]: Not used Bit[3:0]: long_red_a2
0x5087	LENC CTRL7	0x00	RW	Bit[7]: long_red_sign Bit[6:0]: long_red_b1
0x5088	LENC CTRL8	0x01	RW	Bit[7:4]: Not used Bit[3:0]: long_red_b2
0x5089	LENC CTRL9	0x00	RW	Bit[7:3]: Not used Bit[2:0]: long_grn_x0[10:8]
0x508A	LENC CTRL10	0x00	RW	Bit[7:0]: long_grn_x0[7:0]
0x508B	LENC CTRL11	0x00	RW	Bit[7:2]: Not used Bit[1:0]: long_grn_y0[9:8]
0x508C	LENC CTRL12	0x00	RW	Bit[7:0]: long_grn_y0[7:0]
0x508D	LENC CTRL13	0x00	RW	Bit[7]: Not used Bit[6:0]: long_grn_a1
0x508E	LENC CTRL14	0x01	RW	Bit[7:4]: Not used Bit[3:0]: long_grn_a2
0x508F	LENC CTRL15	0x00	RW	Bit[7]: long_grn_sign Bit[6:0]: long_grn_b1
0x5090	LENC CTRL16	0x01	RW	Bit[7:4]: Not used Bit[3:0]: long_grn_b2
0x5091	LENC CTRL17	0x00	RW	Bit[7:3]: Not used Bit[2:0]: long_blu_x0[10:8]
0x5092	LENC CTRL18	0x00	RW	Bit[7:0]: long_blu_x0[7:0]
0x5093	LENC CTRL19	0x00	RW	Bit[7:2]: Not used Bit[1:0]: long_blu_y0[9:8]
0x5094	LENC CTRL20	0x00	RW	Bit[7:0]: long_blu_y0[7:0]
0x5095	LENC CTRL21	0x00	RW	Bit[7]: Not used Bit[6:0]: long_blu_a1

table 5-2 LENC control registers (sheet 3 of 4)

address	register name	default value	R/W	description
0x5096	LENC CTRL22	0x01	RW	Bit[7:4]: Not used Bit[3:0]: long_blu_a2
0x5097	LENC CTRL23	0x0	RW	Bit[7]: long_blu_sign Bit[6:0]: long_blu_b1
0x5098	LENC CTRL24	0x01	RW	Bit[7:4]: Not used Bit[3:0]: long_blu_b2
0x509C	LENC CTRL28	0x00	RW	Bit[7:5]: Not used Bit[4:0]: Min LENC gain
0x509D	LENC CTRL29	0x00	RW	Bit[7:2]: Not used Bit[1:0]: Gain threshold1[9:8] (must less than 0x200)
0x509E	LENC CTRL30	0x00	RW	Bit[7:0]: Gain threshold1[7:0]
0x509F	LENC CTRL31	0x00	RW	Bit[7:2]: Not used Bit[1:0]: Gain threshold2[9:8] (must less than 0x200)
0x50A0	LENC CTRL32	0x00	RW	Bit[7:0]: Gain threshold2[7:0]
0x50A1	LENC CTRL33	0x00	RW	Bit[7:3]: Not used Bit[2:0]: short_red_x0[10:8]
0x50A2	LENC CTRL34	0x00	RW	Bit[7:0]: short_red_x0[7:0]
0x50A3	LENC CTRL35	0x00	RW	Bit[7:2]: Not used Bit[1:0]: short_red_y0[9:8]
0x50A4	LENC CTRL36	0x00	RW	Bit[7:0]: short_red_y0[7:0]
0x50A5	LENC CTRL37	0x00	RW	Bit[7]: Not used Bit[6:0]: short_red_a1
0x50A6	LENC CTRL38	0x01	RW	Bit[7:4]: Not used Bit[3:0]: short_red_a2
0x50A7	LENC CTRL39	0x00	RW	Bit[7]: short_red_sign Bit[6:0]: short_red_b1
0x50A8	LENC CTRL40	0x01	RW	Bit[7:4]: Not used Bit[3:0]: short_red_b2
0x50A9	LENC CTRL41	0x00	RW	Bit[7:3]: Not used Bit[2:0]: short_grn_x0[10:8]
0x50AA	LENC CTRL42	0x00	RW	Bit[7:0]: short_grn_x0[7:0]
0x50AB	LENC CTRL43	0x00	RW	Bit[7:2]: Not used Bit[1:0]: short_grn_y0[9:8]
0x50AC	LENC CTRL44	0x00	RW	Bit[7:0]: short_grn_y0[7:0]
0x50AD	LENC CTRL45	0x00	RW	Bit[7]: Not used Bit[6:0]: short_grn_a1

table 5-2 LENC control registers (sheet 4 of 4)

address	register name	default value	R/W	description
0x50AE	LENC CTRL46	0x01	RW	Bit[7:4]: Not used Bit[3:0]: short_grn_a2
0x50AF	LENC CTRL47	0x00	RW	Bit[7]: short_grn_sign Bit[6:0]: short_grn_b1
0x50B0	LENC CTRL48	0x01	RW	Bit[7:4]: Not used Bit[3:0]: short_grn_b2
0x50B1	LENC CTRL49	0x00	RW	Bit[7:3]: Not used Bit[2:0]: short_blu_x0[10:8]
0x50B2	LENC CTRL50	0x00	RW	Bit[7:0]: short_blu_x0[7:0]
0x50B3	LENC CTRL51	0x00	RW	Bit[7:2]: Not used Bit[1:0]: short_blu_y0[9:8]
0x50B4	LENC CTRL52	0x00	RW	Bit[7:0]: short_blu_y0[7:0]
0x50B5	LENC CTRL53	0x00	RW	Bit[7]: Not used Bit[6:0]: short_blu_a1
0x50B6	LENC CTRL54	0x01	RW	Bit[7:4]: Not used Bit[3:0]: short_blu_a2
0x50B7	LENC CTRL55	0x00	RW	Bit[7]: short_blu_sign Bit[6:0]: short_blu_b1
0x50B8	LENC CTRL56	0x01	RW	Bit[7:4]: Not used Bit[3:0]: short_blu_b2

5.3 auto white balance (AWB)

The raw R, G, and B values of a white object detected by an image sensor vary with the spectrum of the light source. The light source spectrum is usually described by "color temperature". The white balance process applies different gains to each color channel to make the white object appear white in the image.

The OV10635 builds the AWB algorithm to automatically adjust the gain of each channel to achieve white balance. There are two kinds of AWB: Color Temperature (CT) based AWB and simple gray world AWB. CT AWB is based on the color temperature of the scene, which is based on G/R and G/B ratios. Simple AWB calculates the gains based on scene simple statistics of the final image.

For OV10635, AWB gets two sets of statistics separately from long and short channels. It can work in four modes: separated mode, long channel mode, short channel mode and combination mode. In separated mode, the two channels may apply different AWB gain. In other modes, they apply same AWB gain. Based on the two sets of statistics, the AWB will estimate two sets of AWB gain at first. In long or short channel mode, the two channels apply one of the two sets. In combination mode, a weighted average of the two sets of statistics is used to estimate the AWB gain. In separate mode, the two channels will apply the two sets of AWB gain respectively.

table 5-3 AWB registers (sheet 1 of 2)

address	register name	default value	R/W	description
0x5000	ISP_RW00	0xFF	RW	Bit[2]: AWB statistics enable 0: Disable 1: Enable Bit[1]: AWB gain enable 0: Disable 1: Enable
0x5120	ISP_CTRL01	0x00	RW	Bit[0]: White balance (WB) mode select 0: Auto mode 1: Manual mode
0xC4B8	CT_AWB_EN	–	RW	Bit[0]: Select AWB algorithms 0: Select simple WB 1: Select advanced WB When register value is 0x00, it means function is disabled; all other values mean function is enabled. This register value must be initialized by user and must not be removed from start up sequence. Default value is random.
0x5100	GAIN_AWB_CTRL0	0x00	RW	Bit[7:2]: Not used Bit[1:0]: manual_gain_b_long[9:8]
0x5101	GAIN_AWB_CTRL1	0x80	RW	Bit[7:0]: manual_gain_b_long[7:0]
0x5102	GAIN_AWB_CTRL2	0x00	RW	Bit[7:2]: Not used Bit[1:0]: manual_gain_gb_long[9:8]
0x5103	GAIN_AWB_CTRL3	0x80	RW	Bit[7:0]: manual_gain_gb_long[7:0]
0x5104	GAIN_AWB_CTRL4	0x00	RW	Bit[7:2]: Not used Bit[1:0]: manual_gain_gr_long[9:8]
0x5105	GAIN_AWB_CTRL5	0x80	RW	Bit[7:0]: manual_gain_gr_long[7:0]
0x5106	GAIN_AWB_CTRL6	0x00	RW	Bit[7:2]: Not used Bit[1:0]: manual_gain_r_long[9:8]
0x5107	GAIN_AWB_CTRL7	0x80	RW	Bit[7:0]: manual_gain_r_long[7:0]
0x5110	GAIN_AWB_CTRL16	0x00	RW	Bit[7:2]: Not used Bit[1:0]: manual_gain_b_short[9:8]
0x5111	GAIN_AWB_CTRL17	0x80	RW	Bit[7:0]: manual_gain_b_short[7:0]
0x5112	GAIN_AWB_CTRL18	0x00	RW	Bit[7:2]: Not used Bit[1:0]: manual_gain_gb_short[9:8]
0x5113	GAIN_AWB_CTRL19	0x80	RW	Bit[7:0]: manual_gain_gb_short[7:0]
0x5114	GAIN_AWB_CTRL20	0x00	RW	Bit[7:2]: Not used Bit[1:0]: manual_gain_gr_short[9:8]
0x5115	GAIN_AWB_CTRL21	0x80	RW	Bit[7:0]: manual_gain_gr_short[7:0]

table 5-3 AWB registers (sheet 2 of 2)

address	register name	default value	R/W	description
0x5116	GAIN AWB CTRL22	0x00	RW	Bit[7:2]: Not used Bit[1:0]: manual_gain_r_short[9:8]
0x5117	GAIN AWB CTRL23	0x80	RW	Bit[7:0]: manual_gain_r_short[7:0]

5.3.1 simple AWB

Simple AWB algorithm is based on the gray world assumption, meaning the sensor will make the R, G and B average of all pixels equal to each other by adjusting the gain of each color channel.

5.3.2 CT AWB

CT AWB algorithm adjusts R, G and B gain based on the color temperature of the ambient light. It will make the R, G and B channel average of gray pixels equal to each other by adjusting the gain of each color channel. To identify the gray pixels over the color temperature range, the characteristics of a gray object must be calibrated first using the target lens.

table 5-4 AWB long calibration registers (sheet 1 of 4)

address	register name	default value	R/W	description
0x5586	AWB_M_RNG	0x10	RW	Bit[7:0]: AWB_M_RNG[7:0] Tolerance of AWB_M_X and AWB_M_Y in middle color temperature range. Too small of a tolerance results in unstable AWB, while too great of a tolerance results in inaccurate AWB.
0x5587	AWB_L_XRNG	0x10	RW	Bit[7:0]: AWB_L_XRNG[7:0] Tolerance of AWB_L_X in low color temperature range, where AWB_L_X is X characteristics of gray object in low color temperature range. Too small of a tolerance results in unstable AWB, while too great of a tolerance results in inaccurate AWB. Typical value ranges from 0x08~0x18.

table 5-4 AWB long calibration registers (sheet 2 of 4)

address	register name	default value	R/W	description
0x5588	AWB_H_YRNG	0x10	RW	<p>Bit[7:0]: AWB_H_YRNG[7:0] Tolerance of AWB_H_Y in low color temperature range, where AWB_H_Y is Y characteristics of gray object in high color temperature range.</p> <p>Too small of a tolerance results in unstable AWB, while too great of a tolerance results in inaccurate white balance. Typical value ranges from 0x08~0x10.</p>
0x5589	AWB_M_X	0x40	RW	<p>Bit[7:0]: AWB_M_X[7:0] X characteristics of gray object in middle color temperature range.</p> <p>When AWB_M_X increases, gray will shift toward blue in low color temperature light, or red in high color temperature light. When AWB_M_X decreases, gray will shift toward yellow in low color temperature light, or cyan in high color temperature light. If AWB_M_X is too big or too small, AWB algorithm may fail to identify gray object and result is not stable and unpredictable.</p>
0x558A	AWB_M_Y	0x40	RW	<p>Bit[7:0]: AWB_M_Y[7:0] Y characteristics of gray object in middle color temperature range.</p> <p>When AWB_M_Y increases, gray will shift toward blue in low color temperature light, or red in high color temperature light. When AWB_M_Y decreases, gray will shift toward yellow in low color temperature light, or cyan in high color temperature light. If AWB_M_Y is too big or too small, AWB algorithm will fail to identify gray object and result is not stable and unpredictable.</p>

table 5-4 AWB long calibration registers (sheet 3 of 4)

address	register name	default value	R/W	description
0x558B	AWB_L_K	0x00	RW	<p>Bit[7:0]: AWB_L_K K characteristics of gray object in low color temperature range</p> <p>When AWB_L_K increases/decreases, gray color will slightly shift toward yellow/blue, respectively, in low color temperature range. In general, AWB_L_K should be no less than 0x80</p>
0x558C	AWB_H_K	0x00	RW	<p>Bit[7:0]: AWB_H_K K characteristics of gray object in high color temperature range</p> <p>When AWB_H_K increases/decreases, gray color will slightly shift toward cyan/red, respectively, in high color temperature range.</p>
0x558D	AWB_H_LMT	0x00	RW	<p>Bit[7:0]: AWB_H_LMT[7:0] Lower limit of AWB_H_X, where AWB_H_X is X characteristics of gray object in high color temperature range.</p> <p>Smaller AWB_H_LMT covers greater upper limit of color temperature; however, it also results in less accurate white balance</p>
0x558E	AWB_L_LMT	0x00	RW	<p>Bit[7:0]: AWB_L_LMT[7:0] Lower limit of AWB_L_Y, where AWB_L_Y is Y characteristics of gray object in low color temperature range.</p> <p>Smaller AWB_L_LMT covers smaller lower limit of color temperature; however, it also results in less accurate white balance.</p>
0x558F	AWB_DBG1	0x20	RW	<p>Bit[7:0]: AWB_DBG1 Debug control register, not effective in normal usage</p>
0x5590	AWB_DBG2	0x20	RW	<p>Bit[7:0]: AWB_DBG2 Debug control register, not effective in normal usage</p>

table 5-4 AWB long calibration registers (sheet 4 of 4)

address	register name	default value	R/W	description
0x5591	AWB_DATA_ULMT	0xFF	RW	Bit[7:0]: AWB_DATA_ULMT Pixels with output value greater than AWB_DATA_ULMT are excluded in AWB statistics
0x5592	AWB_DATA_LLMT	0x00	RW	Bit[7:0]: AWB_DATA_LLMT Pixels with output value smaller than AWB_DATA_LLMT are excluded in AWB statistics

table 5-5 AWB short calibration registers (sheet 1 of 3)

address	register name	default value	R/W	description
0x559F	AWB_M_RNG	0x10	RW	Bit[7:0]: AWB_M_RNG[7:0] Tolerance of AWB_M_X and AWB_M_Y in middle color temperature range Too small of a tolerance results in unstable AWB, while too great of a tolerance results in inaccurate AWB.
0x55A0	AWB_L_XRNG	0x10	RW	Bit[7:0]: AWB_L_XRNG[7:0] Tolerance of AWB_L_X in low color temperature range, where AWB_L_X is X characteristics of gray object in low color temperature range. Too small of a tolerance results in unstable AWB, while too great of a tolerance results in inaccurate AWB. Typical value ranges from 0x08~0x18.
0x55A1	AWB_H_YRNG	0x10	RW	Bit[7:0]: AWB_H_YRNG[7:0] Tolerance of AWB_H_Y in low color temperature range, where AWB_H_Y is Y characteristics of gray object in high color temperature range. Too small of a tolerance results in unstable AWB, while too great of a tolerance results in inaccurate white balance. Typical value ranges from 0x08~0x10.

table 5-5 AWB short calibration registers (sheet 2 of 3)

address	register name	default value	R/W	description
0x55A2	AWB_M_X	0x40	RW	<p>Bit[7:0]: AWB_M_X[7:0] X characteristics of gray object in middle color temperature range.</p> <p>When AWB_M_X increases, gray will shift toward blue in low color temperature light, or red in high color temperature light. When AWB_M_X decreases, gray will shift toward yellow in low color temperature light, or cyan in high color temperature light. If AWB_M_X is too big or too small, AWB algorithm may fail to identify gray object and result is not stable and unpredictable.</p>
0x55A3	AWB_M_Y	0x40	RW	<p>Bit[7:0]: AWB_M_Y[7:0] Y characteristics of gray object in middle color temperature range.</p> <p>When AWB_M_Y increases, gray will shift toward blue in low color temperature light, or red in high color temperature light. When AWB_M_Y decreases, gray will shift toward yellow in low color temperature light, or cyan in high color temperature light. If AWB_M_Y is too big or too small, AWB algorithm will fail to identify gray object and result is not stable and unpredictable.</p>
0x55A4	AWB_L_K	0x00	RW	<p>Bit[7:0]: AWB_L_K K characteristics of gray object in low color temperature range.</p> <p>When AWB_L_K increases/decreases, gray color will slightly shift toward yellow/blue, respectively, in low color temperature range. In general, AWB_L_K should be no less than 0x80.</p>
0x55A5	AWB_H_K	0x00	RW	<p>Bit[7:0]: AWB_H_K K characteristics of gray object in high color temperature range.</p> <p>When AWB_H_K increases/decreases, gray color will slightly shift toward cyan/red, respectively, in high color temperature range.</p>

table 5-5 AWB short calibration registers (sheet 3 of 3)

address	register name	default value	R/W	description
0x55A6	AWB_H_LMT	0x00	RW	<p>Bit[7:0]: AWB_H_LMT[7:0] Lower limit of AWB_H_X, where AWB_H_X is X characteristics of gray object in high color temperature range.</p> <p>Smaller AWB_H_LMT covers greater upper limit of color temperature; however, it also results in less accurate white balance</p>
0x55A7	AWB_L_LMT	0x00	RW	<p>Bit[7:0]: AWB_L_LMT[7:0] Lower limit of AWB_L_Y, where AWB_L_Y is Y characteristics of gray object in low color temperature range.</p> <p>Smaller AWB_L_LMT covers smaller lower limit of color temperature; however, it also results in less accurate white balance.</p>
0x55A8	AWB_DBG1	0x20	RW	<p>Bit[7:0]: AWB_DBG1 Debug control register, not effective in normal usage</p>
0x55A9	AWB_DBG2	0x20	RW	<p>Bit[7:0]: AWB_DBG2 Debug control register, not effective in normal usage</p>
0x55AA	AWB_DATA_ULMT	0xFF	RW	<p>Bit[7:0]: AWB_DATA_ULMT Pixels with output value greater than AWB_DATA_ULMT are excluded in AWB statistics</p>
0x55AB	AWB_DATA_LLMT	0x00	RW	<p>Bit[7:0]: AWB_DATA_LLMT Pixels with output value smaller than AWB_DATA_LLMT are excluded in AWB statistics</p>

5.3.3 AWB control

table 5-6 AWB control registers

address	register name	default value	R/W	description
0x5581	AWB CT CTRL1	0x5B	RW	Bit[7:4]: Not used Bit[3:2]: Scale of AWB_L_K and AWB_H_K for long exposure. It is usually set to 2'b01 00: 2x 01: 4x 10: 8x 11: Not allowed Bit[1:0]: AWB debug mode Changing these registers is not recommended.
0x5583	AWB CT CTRL3	0x10	RW	Bit[7:6]: Scale of AWB_L_K and AWB_H_K for short exposure, it is usually set to 2'b01 00: 2x 01: 4x 10: 8x 11: Not allowed Bit[4]: Fast adjustment enable in simple AWB mode 0: Disable, AWB speed is slow 1: Enable, AWB adjustment is fast for fast scene change Bit[3:2]: AWB statistics window selection 00: Full image 01: Exclude 8 rows and columns at each image boundary 10: Exclude 1/8 of total rows and columns at each image boundary 11: Exclude 1/4 of total rows and columns at each image boundary Bit[1:0]: AWB debug control Changing these registers is not recommended.

5.3.4 AWB stable range and gain range

The R, G and B gain can be further limited by register MAX_AWB_GAIN.

table 5-7 AWB range registers

address	register name	default value	R/W	description
0xC2E6	MAX_AWB_GAIN1	–	RW	Bit[7:0]: Maximum gain MSB of R/G/B channel This register value will be automatically initialized by sensor after powering up. Default value is random.
0xC2E7	MAX_AWB_GAIN2	–	RW	Bit[7:0]: Maximum gain LSB of R/G/B channel This register value will be automatically initialized by sensor after powering up. Default value is random.

5.4 de-noise (DNS)

The DNS block uses a low pass filter to remove white noise in each color channel and white noise between Gb and Gr. Control parameters are separated for long and short exposures. A difference below the threshold is treated as noise and will be smoothed. A difference above the threshold is treated as an edge and will be preserved. The low pass filter is adaptive to the gain value.

figure 5-2 RAW domain DNS - long

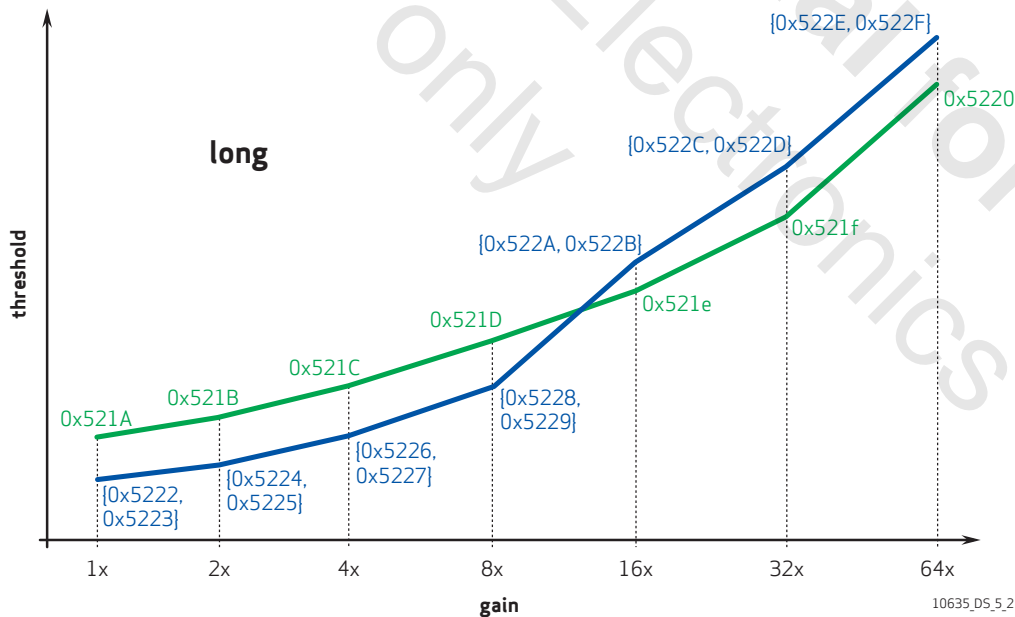

figure 5-3 RAW domain DNS - short

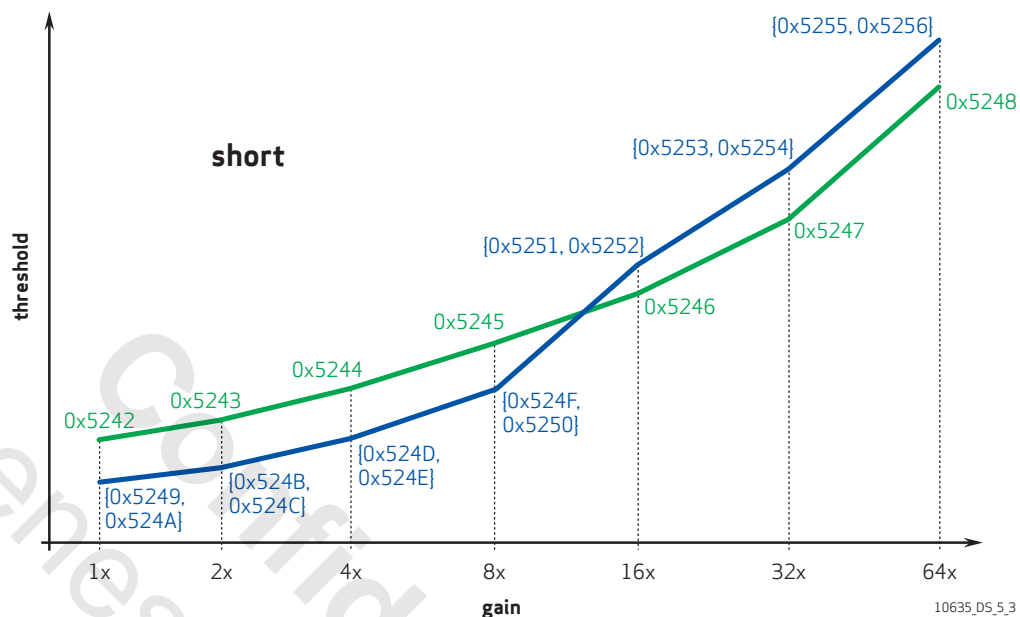

table 5-8 DNS control registers (sheet 1 of 4)

address	register name	default value	R/W	description
0x5000	ISP RW00	0xFF	RW	Bit[5]: dns_en
0x5210	DNS CTRL10	0x04	RW	Bit[7:4]: Not used Bit[3:0]: noise_y_a for long exposure sub-pixel
0x5211	DNS CTRL11	0x08	RW	Bit[7:5]: Not used Bit[4:0]: noise_uv_a for long exposure sub-pixel
0x5212	DNS CTRL12	0x00	RW	Bit[7:1]: Not used Bit[0]: dns_manual for long exposure sub-pixel
0x5213	DNS CTRL13	0x02	RW	Bit[7:0]: noise_y for long exposure sub-pixel
0x5214	DNS CTRL14	0x00	RW	Bit[7:1]: Not used Bit[0]: noise_u[8] for long exposure sub-pixel
0x5215	DNS CTRL15	0x02	RW	Bit[7:0]: noise_u[7:0] for long exposure sub-pixel
0x5216	DNS CTRL16	0x00	RW	Bit[7:1]: Not used Bit[0]: noise_v[8] for long exposure sub-pixel
0x5217	DNS CTRL17	0x02	RW	Bit[7:0]: noise_v[7:0] for long exposure sub-pixel
0x5218	DNS CTRL18	0x06	RW	Bit[7:0]: dns_edgethre for long exposure sub-pixel

table 5-8 DNS control registers (sheet 2 of 4)

address	register name	default value	R/W	description
0x5219	DNS CTRL19	0x04	RW	Bit[7:4]: Not used Bit[3]: Reserved Bit[2:0]: dns_gbgr_extra[2:0] for long exposure sub-pixel
0x521A	DNS CTRL20	0x02	RW	Bit[7:0]: noise_y_list_0 for long exposure sub-pixel
0x521B	DNS CTRL21	0x04	RW	Bit[7:0]: noise_y_list_1 for long exposure sub-pixel
0x521C	DNS CTRL22	0x08	RW	Bit[7:0]: noise_y_list_2 for long exposure sub-pixel
0x521D	DNS CTRL23	0x14	RW	Bit[7:0]: noise_y_list_3 for long exposure sub-pixel
0x521E	DNS CTRL24	0x1E	RW	Bit[7:0]: noise_y_list_4 for long exposure sub-pixel
0x521F	DNS CTRL25	0x28	RW	Bit[7:0]: noise_y_list_5 for long exposure sub-pixel
0x5220	DNS CTRL26	0x32	RW	Bit[7:0]: noise_y_list_6_l for long exposure sub-pixel
0x5222	DNS CTRL28	0x00	RW	Bit[7:1]: Not used Bit[0]: noise_uv_list_0[8] for long exposure sub-pixel
0x5223	DNS CTRL29	0x02	RW	Bit[7:0]: noise_uv_list_0[7:0] for long exposure sub-pixel
0x5224	DNS CTRL30	0x00	RW	Bit[7:1]: Not used Bit[0]: noise_uv_list_1[8] for long exposure sub-pixel
0x5225	DNS CTRL31	0x04	RW	Bit[7:0]: noise_uv_list_1[7:0] for long exposure sub-pixel
0x5226	DNS CTRL32	0x00	RW	Bit[7:1]: Not used Bit[0]: noise_uv_list_2[8] for long exposure sub-pixel
0x5227	DNS CTRL33	0x0C	RW	Bit[7:0]: noise_uv_list_2[7:0] for long exposure sub-pixel
0x5228	DNS CTRL34	0x00	RW	Bit[7:1]: Not used Bit[0]: noise_uv_list_3[8] for long exposure sub-pixel
0x5229	DNS CTRL35	0x28	RW	Bit[7:0]: noise_uv_list_3[7:0] for long exposure sub-pixel
0x522A	DNS CTRL36	0x00	RW	Bit[7:1]: Not used Bit[0]: noise_uv_list_4[8] for long exposure sub-pixel
0x522B	DNS CTRL37	0x32	RW	Bit[7:0]: noise_uv_list_4[7:0] for long exposure sub-pixel
0x522C	DNS CTRL38	0x00	RW	Bit[7:1]: Not used Bit[0]: noise_uv_list_5[8] for long exposure sub-pixel
0x522D	DNS CTRL39	0x3C	RW	Bit[7:0]: noise_uv_list_5[7:0] for long exposure sub-pixel
0x522E	DNS CTRL40	0x00	RW	Bit[7:1]: Not used Bit[0]: noise_uv_list_6[8] for long exposure sub-pixel
0x522F	DNS CTRL41	0x4C	RW	Bit[7:0]: noise_uv_list_6[7:0] for long exposure sub-pixel
0x5238	DNS CTRL50	0x04	RW	Bit[7:4]: Not used Bit[3:0]: noise_y_a for short exposure sub-pixel

table 5-8 DNS control registers (sheet 3 of 4)

address	register name	default value	R/W	description
0x5239	DNS CTRL51	0x08	RW	Bit[7:5]: Not used Bit[4:0]: noise_uv_a for short exposure sub-pixel
0x523A	DNS CTRL52	0x00	RW	Bit[7:1]: Not used Bit[0]: dns_manual for short exposure sub-pixel
0x523B	DNS CTRL53	0x02	RW	Bit[7:0]: noise_y for short exposure sub-pixel
0x523C	DNS CTRL54	0x00	RW	Bit[7:1]: Not used Bit[0]: noise_u[8] for short exposure sub-pixel
0x523D	DNS CTRL55	0x02	RW	Bit[7:0]: noise_u[7:0] for short exposure sub-pixel
0x523E	DNS CTRL56	0x00	RW	Bit[7:1]: Not used Bit[0]: noise_v[8] for short exposure sub-pixel
0x523F	DNS CTRL57	0x02	RW	Bit[7:0]: noise_v[7:0] for short exposure sub-pixel
0x5240	DNS CTRL58	0x06	RW	Bit[7:0]: dns_edgethre for short exposure sub-pixel
0x5241	DNS CTRL59	0x04	RW	Bit[7:4]: Not used Bit[3]: Reserved Bit[2:0]: dns_gbgr_extra[2:0] for short exposure sub-pixel
0x5242	DNS CTRL60	0x02	RW	Bit[7:0]: noise_y_list_0 for short exposure sub-pixel
0x5243	DNS CTRL61	0x04	RW	Bit[7:0]: noise_y_list_1 for short exposure sub-pixel
0x5244	DNS CTRL62	0x08	RW	Bit[7:0]: noise_y_list_2 for short exposure sub-pixel
0x5245	DNS CTRL63	0x14	RW	Bit[7:0]: noise_y_list_3 for short exposure sub-pixel
0x5246	DNS CTRL64	0x1E	RW	Bit[7:0]: noise_y_list_4 for short exposure sub-pixel
0x5247	DNS CTRL65	0x28	RW	Bit[7:0]: noise_y_list_5 for short exposure sub-pixel
0x5248	DNS CTRL66	0x32	RW	Bit[7:0]: noise_y_list_6 for short exposure sub-pixel
0x5249	DNS CTRL67	0x00	RW	Bit[7:1]: Not used Bit[0]: noise_uv_list_0[8] for short exposure sub-pixel
0x524A	DNS CTRL68	0x02	RW	Bit[7:0]: noise_uv_list_0[7:0] for short exposure sub-pixel
0x524B	DNS CTRL69	0x00	RW	Bit[7:1]: Not used Bit[0]: noise_uv_list_1[8] for short exposure sub-pixel
0x524C	DNS CTRL70	0x04	RW	Bit[7:0]: noise_uv_list_1[7:0] for short exposure sub-pixel
0x524D	DNS CTRL71	0x00	RW	Bit[7:1]: Not used Bit[0]: noise_uv_list_2[8] for short exposure sub-pixel
0x524E	DNS CTRL72	0x0C	RW	Bit[7:0]: noise_uv_list_2[7:0] for short exposure sub-pixel
0x524F	DNS CTRL73	0x00	RW	Bit[7:1]: Not used Bit[0]: noise_uv_list_3[8] for short exposure sub-pixel
0x5250	DNS CTRL74	0x28	RW	Bit[7:0]: noise_uv_list_3[7:0] for short exposure sub-pixel

table 5-8 DNS control registers (sheet 4 of 4)

address	register name	default value	R/W	description
0x5251	DNS CTRL75	0x00	RW	Bit[7:1]: Not used Bit[0]: noise_uv_list_4[8] for short exposure sub-pixel
0x5252	DNS CTRL76	0x32	RW	Bit[7:0]: noise_uv_list_4[7:0] for short exposure sub-pixel
0x5253	DNS CTRL77	0x00	RW	Bit[7:1]: Not used Bit[0]: noise_uv_list_5[8] for short exposure sub-pixel
0x5254	DNS CTRL78	0x3C	RW	Bit[7:0]: noise_uv_list_5[7:0] for short exposure sub-pixel
0x5255	DNS CTRL79	0x00	RW	Bit[7:1]: Not used Bit[0]: noise_uv_list_6[8] for short exposure sub-pixel
0x5256	DNS CTRL80	0x4C	RW	Bit[7:0]: noise_uv_list_6[7:0] for short exposure sub-pixel

5.5 color interpolation (CIP)

CIP block interpolates raw R,G,B pixels to RGB space. It also contains the sharpen function.

figure 5-4 CIP sharpen curve

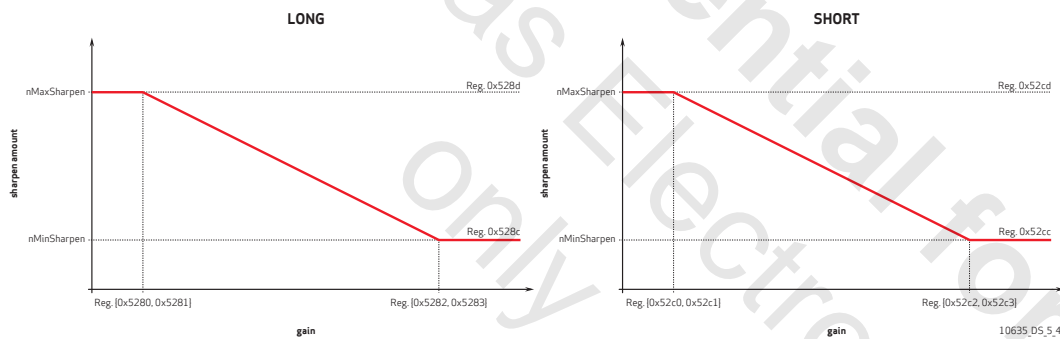

table 5-9 CIP control registers (sheet 1 of 6)

address	register name	default value	R/W	description
0x5000	ISP RW00	1'b1	RW	Bit[6]: cip_en
0x5280	CIP CTRL00	0x00	RW	Bit[1:0]: min_gain[9:8] for long exposure Min_gain is used in CIP_start module and is used to judge in which range current sensor is in

table 5-9 CIP control registers (sheet 2 of 6)

address	register name	default value	R/W	description
0x5281	CIP_CTRL01	0x10	RW	Bit[7:0]: min_gain[7:0] for long exposure Min_gain is used in CIP_start module and is used to judge in which range current sensor is in
0x5282	CIP_CTRL02	0x00	RW	Bit[1:0]: max_gain[9:8] for long exposure Max_gain is used in CIP_start module and is used to judge in which range current sensor is in
0x5283	CIP_CTRL03	0x80	RW	Bit[7:0]: max_gain[7:0] for long exposure Max_gain is used in CIP_start module and is used to judge in which range current sensor is in
0x5284	CIP_CTRL04	0x00	RW	Bit[0]: min_noise[8] for long exposure Min_noise is used for calculating int_noise in auto mode
0x5285	CIP_CTRL05	0x10	RW	Bit[7:0]: min_noise[7:0] for long exposure Min_noise is used for calculating int_noise in auto mode
0x5286	CIP_CTRL06	0x01	RW	Bit[1:0]: noise_slope[9:8] for long exposure Slope value used for calculating int_noise in auto mode
0x5287	CIP_CTRL07	0x00	RW	Bit[7:0]: noise_slope[7:0] for long exposure Slope value used for calculating int_noise in auto mode
0x5288	CIP_CTRL08	0x10	RW	Bit[7:0]: unsharpen_mask0 for long exposure UnSharpenMask0 used in some filters as multipliers
0x5289	CIP_CTRL09	0x30	RW	Bit[7:0]: unsharpen_mask1 for long exposure UnSharpenMask0 used in some filters as multipliers
0x528A	CIP_CTRL0A	0x10	RW	Bit[1]: man_en for long exposure Enable manual mode Bit[0]: anti_aliasing for long exposure Enable anti-aliasing
0x528B	CIP_CTRL0B	0x02	RW	Bit[3:0]: combine_alpha[3:0] for long exposure Combine coefficients for U, V and H components
0x528C	CIP_CTRL0C	0x00	RW	Bit[4:0]: min_sharpen[4:0] for long exposure Min_sharpen is used for sharpen_p calculation in auto mode
0x528D	CIP_CTRL0D	0x10	RW	Bit[5:0]: max_sharpen[5:0] for long exposure Max_sharpen is used for sharpen_p calculation in auto mode

table 5-9 CIP control registers (sheet 3 of 6)

address	register name	default value	R/W	description
0x528E	CIP_CTRL0E	0x10	RW	Bit[5:0]: min_sharpen_tp[5:0] for long exposure Min_sharpen_tp is used for sharpen_tp computation in auto mode
0x528F	CIP_CTRL0F	0x60	RW	Bit[7:0]: max_sharpen_tp[7:0] for long exposure Max_sharpen_tp is used for sharpen_tp calculation in auto mode
0x5290	CIP_CTRL10	0x20	RW	Bit[5:0]: min_sharpen_tm[5:0] for long exposure Min_sharpen_tm is used for sharpen_tm calculation in auto mode
0x5291	CIP_CTRL11	0x60	RW	Bit[7:0]: max_sharpen_tm[7:0] for long exposure Max_sharpen_tm is used for sharpen_tm calculation in auto mode
0x5292	CIP_CTRL12	0x40	RW	Bit[7:0]: sharpen_tya[7:0] for long exposure Threshold used for function of adaptive sharpen
0x5293	CIP_CTRL13	0x10	RW	Bit[4:0]: sharpen_alpha[4:0] for long exposure Sharpen_alpha is used for calculating sharpen_m after sharpen_p is obtained
0x5294	CIP_CTRL14	0x06	RW	Bit[5:0]: mthre[5:0] for long exposure Threshold for medium frequency signals
0x5295	CIP_CTRL15	0x08	RW	Bit[5:0]: hthre[5:0] for long exposure Threshold for high frequency signals
0x5297	CIP_CTRL17	0x06	RW	Bit[3:0]: hfreq_coef[3:0] for long exposure Coefficients for high frequency signals
0x5298	CIP_CTRL18	0x00	RW	Bit[1:0]: efreq_coef[1:0] for long exposure Coefficients for E frequency signals
0x5299	CIP_CTRL19	0x08	RW	Bit[5:0]: lthre[5:0] for long exposure Threshold for low frequency signals
0x529A	CIP_CTRL1A	0x00	RW	Bit[1:0]: man_int_noise[9:8] for long exposure Int_noise is input only in manual mode and is used as threshold in some filters
0x529B	CIP_CTRL1B	0x30	RW	Bit[7:0]: man_int_noise[7:0] for long exposure Int_noise is input only in manual mode and is used as threshold in some filters
0x529C	CIP_CTRL1C	0x00	RW	Bit[0]: man_inv_noise[8] for long exposure Inv_noise is input only in manual mode and is used as threshold in some filters
0x529D	CIP_CTRL1D	0x55	RW	Bit[7:0]: man_inv_noise[7:0] for long exposure Inv_noise is input only in manual mode and is used as threshold in some filters

table 5-9 CIP control registers (sheet 4 of 6)

address	register name	default value	R/W	description
0x529E	CIP CTRL1E	0x08	RW	Bit[5:0]: man_sharpen_p[5:0] for long exposure Sharpen_p is input only in manual mode and is used for function of adaptive sharpen
0x529F	CIP CTRL1F	0x08	RW	Bit[6:0]: man_sharpen_m[6:0] for long exposure Sharpen_m is input only in manual mode and is used for function of adaptive sharpen
0x52A0	CIP CTRL20	0x06	RW	Bit[7:0]: man_sharpen_tp[7:0] for long exposure Sharpen_tp is input only in manual mode and is used for function of adaptive sharpen
0x52A1	CIP CTRL21	0x08	RW	Bit[7:0]: man_sharpen_tm[7:0] for long exposure Sharpen_tm is input only in manual mode and is used for function of adaptive sharpen
0x52C0	CIP CTRL40	0x00	RW	Bit[1:0]: min_gain[9:8] for short exposure Min_gain is used in CIP_start module and is used to judge in which range current sensor is in
0x52C1	CIP CTRL41	0x10	RW	Bit[7:0]: min_gain[7:0] for short exposure Min_gain is used in CIP_start module and is used to judge in which range current sensor is in
0x52C2	CIP CTRL42	0x00	RW	Bit[1:0]: max_gain[9:8] for short exposure Max_gain is used in CIP_start module and is used to judge in which range current sensor is in
0x52C3	CIP CTRL43	0x80	RW	Bit[7:0]: max_gain[7:0] for short exposure Max_gain is used in CIP_start module and is used to judge in which range current sensor is in
0x52C4	CIP CTRL44	0x00	RW	Bit[0]: min_noise[8] for short exposure Min_noise used for calculating int_noise in auto mode
0x52C5	CIP CTRL45	0x10	RW	Bit[7:0]: min_noise[7:0] for short exposure Min_noise used for calculating int_noise in auto mode
0x52C6	CIP CTRL46	0x01	RW	Bit[1:0]: noise_slope[9:8] for short exposure Slope value used for calculating int_noise in auto mode
0x52C7	CIP CTRL47	0x00	RW	Bit[7:0]: noise_slope[7:0] for short exposure Slope value used for calculating int_noise in auto mode
0x52C8	CIP CTRL48	0x10	RW	Bit[7:0]: unsharpen_mask0 for short exposure UnSharpenMask0 used in some filters as multipliers

table 5-9 CIP control registers (sheet 5 of 6)

address	register name	default value	R/W	description
0x52C9	CIP CTRL49	0x30	RW	Bit[7:0]: unsharpen_mask1 for short exposure UnSharpenMask0 used in some filters as multipliers
0x52CA	CIP CTRL4A	0x01	RW	Bit[1]: man_en for short exposure Enable manual mode Bit[0]: anti_aliasing for short exposure Enable anti-aliasing
0x52CB	CIP CTRL4B	0x02	RW	Bit[3:0]: combine_alpha[3:0] for short exposure Combine coefficients for U, V and H components
0x52CC	CIP CTRL4C	0x00	RW	Bit[4:0]: min_sharpen[4:0] for short exposure Min_sharpen is used for sharpen_p calculation in auto mode
0x52CD	CIP CTRL4D	0x00	RW	Bit[5:0]: max_sharpen[5:0] for short exposure Max_sharpen is used for sharpen_p calculation in auto mode
0x52CE	CIP CTRL4E	0x10	RW	Bit[5:0]: min_sharpen_tp[5:0] for short exposure Min_sharpen_tp is used for sharpen_tp calculation in auto mode
0x52CF	CIP CTRL4F	0x60	RW	Bit[7:0]: max_sharpen_tp[7:0] for short exposure Max_sharpen_tp is used for sharpen_tp calculation in auto mode
0x52D0	CIP CTRL50	0x20	RW	Bit[5:0]: min_sharpen_tm[5:0] for short exposure Min_sharpen_tm is used for sharpen_tm calculation in auto mode
0x52D1	CIP CTRL51	0x60	RW	Bit[7:0]: max_sharpen_tm[7:0] for short exposure Max_sharpen_tm is used for sharpen_tm calculation in auto mode
0x52D2	CIP CTRL52	0x40	RW	Bit[7:0]: sharpen_tya[7:0] for short exposure Threshold used for function of adaptive sharpen
0x52D3	CIP CTRL53	0x10	RW	Bit[4:0]: sharpen_alpha[4:0] for short exposure Sharpen_alpha is used for calculating sharpen_m after sharpen_p is obtained
0x52D4	CIP CTRL54	0x06	RW	Bit[5:0]: mthre[5:0] for short exposure Threshold for medium frequency signals
0x52D5	CIP CTRL55	0x08	RW	Bit[5:0]: hthre[5:0] for short exposure Threshold for high frequency signals
0x52D7	CIP CTRL57	0x06	RW	Bit[3:0]: hfreq_coef[3:0] for short exposure Coefficients for high frequency signals
0x52D8	CIP CTRL58	0x00	RW	Bit[1:0]: efreq_coef[1:0] for short exposure Coefficients for E frequency signals

table 5-9 CIP control registers (sheet 6 of 6)

address	register name	default value	R/W	description
0x52D9	CIP CTRL59	0x08	RW	Bit[5:0]: lthre[5:0] for short exposure Threshold for low frequency signals
0x52DA	CIP CTRL5A	0x00	RW	Bit[1:0]: man_int_noise[9:8] for short exposure Int_noise is input only in manual mode and is used as threshold in some filters
0x52DB	CIP CTRL5B	0x30	RW	Bit[7:0]: man_int_noise[7:0] for short exposure Int_noise is input only in manual mode and is used as threshold in some filters
0x52DC	CIP CTRL5C	0x00	RW	Bit[0]: man_inv_noise[8] for short exposure Inv_noise is input only in manual mode and is used as threshold in some filters
0x52DD	CIP CTRL5D	0x55	RW	Bit[7:0]: man_inv_noise[7:0] for short exposure Inv_noise is input only in manual mode and is used as threshold in some filters
0x52DE	CIP CTRL5E	0x08	RW	Bit[5:0]: man_sharpen_p[5:0] for short exposure Sharpen_p is input only in manual mode and is used for function of adaptive sharpen
0x52DF	CIP CTRL5F	0x08	RW	Bit[6:0]: man_sharpen_m[6:0] for short exposure Sharpen_m is input only in manual mode and is used for function of adaptive sharpen
0x52E0	CIP CTRL60	0x06	RW	Bit[7:0]: man_sharpen_tp[7:0] for short exposure Sharpen_tp is input only in manual mode and is used for function of adaptive sharpen
0x52E1	CIP CTRL61	0x08	RW	Bit[7:0]: man_sharpen_tm[7:0] for short exposure Sharpen_tm is input only in manual mode and is used for function of adaptive sharpen

5.6 color matrix (CMX)

The main purpose of color matrix (CMX) is color correction. There is generally no need to change these register values.

$$\begin{bmatrix} \{0xC318, 0xC319\} & \{0xC31A, 0xC31B\} & \{0xC31C, 0xC31D\} \\ \{0xC31E, 0xC31F\} & \{0xC320, 0xC321\} & \{0xC322, 0xC323\} \\ \{0xC324, 0xC325\} & \{0xC326, 0xC327\} & \{0xC328, 0xC329\} \\ \{0xC32A, 0xC32B\} & \{0xC32C, 0xC32D\} & \{0xC32E, 0xC32F\} \end{bmatrix} = 256 \times \begin{bmatrix} 0.114 & 0.587 & 0.299 \\ 0.5 & -0.331 & -0.169 \\ -0.056 & 0.278 & -0.222 \\ -0.081 & -0.419 & 0.5 \end{bmatrix} \times [\text{CCM}] \text{ long}$$

$$\begin{bmatrix} \{0xC330, 0xC331\} & \{0xC332, 0xC333\} & \{0xC334, 0xC335\} \\ \{0xC336, 0xC337\} & \{0xC338, 0xC339\} & \{0xC33A, 0xC33B\} \\ \{0xC33C, 0xC33D\} & \{0xC33E, 0xC33F\} & \{0xC340, 0xC341\} \\ \{0xC342, 0xC343\} & \{0xC344, 0xC345\} & \{0xC346, 0xC347\} \end{bmatrix} = 256 \times \begin{bmatrix} 0.114 & 0.587 & 0.299 \\ 0.5 & -0.331 & -0.169 \\ -0.056 & -0.278 & -0.222 \\ -0.081 & -0.419 & 0.5 \end{bmatrix} \times [\text{CCM}] \text{ short}$$

table 5-10 CMX control registers (sheet 1 of 6)

address	register name	default value	R/W	description
0x5000	ISP_CTRL00	0x01	RW	Bit[7]: cmx_en 0: Disable CMX 1: Enable CMX
				Bit[7:0]: Long color matrix 1[15:8]
0xC318	COLOR_MATRIX_L_1_1	-	RW	This register value must be initialized by user and must not be removed from start up sequence. Default value is random.
				Bit[7:0]: Long color matrix 1[7:0]
0xC319	COLOR_MATRIX_L_1_2	-	RW	This register value must be initialized by user and must not be removed from start up sequence. Default value is random.
				Bit[7:0]: Long color matrix 2[15:8]
0xC31A	COLOR_MATRIX_L_2_1	-	RW	This register value must be initialized by user and must not be removed from start up sequence. Default value is random.
				Bit[7:0]: Long color matrix 2[7:0]
0xC31B	COLOR_MATRIX_L_2_2	-	RW	This register value must be initialized by user and must not be removed from start up sequence. Default value is random.
				Bit[7:0]: Long color matrix 3[15:8]
0xC31C	COLOR_MATRIX_L_3_1	-	RW	This register value must be initialized by user and must not be removed from start up sequence. Default value is random.

table 5-10 CMX control registers (sheet 2 of 6)

address	register name	default value	R/W	description
0xC31D	COLOR_MATRIX_L_3_2	–	RW	Bit[7:0]: Long color matrix 3[7:0] This register value must be initialized by user and must not be removed from start up sequence. Default value is random.
0xC31E	COLOR_MATRIX_L_4_1	–	RW	Bit[7:0]: Long color matrix 4[15:8] This register value must be initialized by user and must not be removed from start up sequence. Default value is random.
0xC31F	COLOR_MATRIX_L_4_2	–	RW	Bit[7:0]: Long color matrix 4[7:0] This register value must be initialized by user and must not be removed from start up sequence. Default value is random.
0xC320	COLOR_MATRIX_L_5_1	–	RW	Bit[7:0]: Long color matrix 5[15:8] This register value must be initialized by user and must not be removed from start up sequence. Default value is random.
0xC321	COLOR_MATRIX_L_5_2	–	RW	Bit[7:0]: Long color matrix 5[7:0] This register value must be initialized by user and must not be removed from start up sequence. Default value is random.
0xC322	COLOR_MATRIX_L_6_1	–	RW	Bit[7:0]: Long color matrix 6[15:8] This register value must be initialized by user and must not be removed from start up sequence. Default value is random.
0xC323	COLOR_MATRIX_L_6_2	–	RW	Bit[7:0]: Long color matrix 6[7:0] This register value must be initialized by user and must not be removed from start up sequence. Default value is random.
0xC324	COLOR_MATRIX_L_7_1	–	RW	Bit[7:0]: Long color matrix 7[15:8] This register value must be initialized by user and must not be removed from start up sequence. Default value is random.
0xC325	COLOR_MATRIX_L_7_2	–	RW	Bit[7:0]: Long color matrix 7[7:0] This register value must be initialized by user and must not be removed from start up sequence. Default value is random.

table 5-10 CMX control registers (sheet 3 of 6)

address	register name	default value	R/W	description
0xC326	COLOR_MATRIX_L_8_1	–	RW	Bit[7:0]: Long color matrix 8[15:8] This register value must be initialized by user and must not be removed from start up sequence. Default value is random.
0xC327	COLOR_MATRIX_L_8_2	–	RW	Bit[7:0]: Long color matrix 8[7:0] This register value must be initialized by user and must not be removed from start up sequence. Default value is random.
0xC328	COLOR_MATRIX_L_9_1	–	RW	Bit[7:0]: Long color matrix 9[15:8] This register value must be initialized by user and must not be removed from start up sequence. Default value is random.
0xC329	COLOR_MATRIX_L_9_2	–	RW	Bit[7:0]: Long color matrix 9[7:0] This register value must be initialized by user and must not be removed from start up sequence. Default value is random.
0xC32A	COLOR_MATRIX_L_10_1	–	RW	Bit[7:0]: Long color matrix 10[15:8] This register value must be initialized by user and must not be removed from start up sequence. Default value is random.
0xC32B	COLOR_MATRIX_L_10_2	–	RW	Bit[7:0]: Long color matrix 10[7:0] This register value must be initialized by user and must not be removed from start up sequence. Default value is random.
0xC32C	COLOR_MATRIX_L_11_1	–	RW	Bit[7:0]: Long color matrix 11[15:8] This register value must be initialized by user and must not be removed from start up sequence. Default value is random.
0xC32D	COLOR_MATRIX_L_11_2	–	RW	Bit[7:0]: Long color matrix 11[7:0] This register value must be initialized by user and must not be removed from start up sequence. Default value is random.
0xC32E	COLOR_MATRIX_L_12_1	–	RW	Bit[7:0]: Long color matrix 12[15:8] This register value must be initialized by user and must not be removed from start up sequence. Default value is random.

table 5-10 CMX control registers (sheet 4 of 6)

address	register name	default value	R/W	description
0xC32F	COLOR_MATRIX_L_12_2	–	RW	Bit[7:0]: Long color matrix 12[7:0] This register value must be initialized by user and must not be removed from start up sequence. Default value is random.
0xC330	COLOR_MATRIX_S_1_1	–	RW	Bit[7:0]: Short color matrix 1[15:8] This register value must be initialized by user and must not be removed from start up sequence. Default value is random.
0xC331	COLOR_MATRIX_S_1_2	–	RW	Bit[7:0]: Short color matrix 1[7:0] This register value must be initialized by user and must not be removed from start up sequence. Default value is random.
0xC332	COLOR_MATRIX_S_2_1	–	RW	Bit[7:0]: Short color matrix 2[15:8] This register value must be initialized by user and must not be removed from start up sequence. Default value is random.
0xC333	COLOR_MATRIX_S_2_2	–	RW	Bit[7:0]: Short color matrix 2[7:0] This register value must be initialized by user and must not be removed from start up sequence. Default value is random.
0xC334	COLOR_MATRIX_S_3_1	–	RW	Bit[7:0]: Short color matrix 3[15:8] This register value must be initialized by user and must not be removed from start up sequence. Default value is random.
0xC335	COLOR_MATRIX_S_3_2	–	RW	Bit[7:0]: Short color matrix 3[7:0] This register value must be initialized by user and must not be removed from start up sequence. Default value is random.
0xC336	COLOR_MATRIX_S_4_1	–	RW	Bit[7:0]: Short color matrix 4[15:8] This register value must be initialized by user and must not be removed from start up sequence. Default value is random.
0xC337	COLOR_MATRIX_S_4_2	–	RW	Bit[7:0]: Short color matrix 4[7:0] This register value must be initialized by user and must not be removed from start up sequence. Default value is random.

table 5-10 CMX control registers (sheet 5 of 6)

address	register name	default value	R/W	description
0xC338	COLOR_MATRIX_S_5_1	–	RW	Bit[7:0]: Short color matrix 5[15:8] This register value must be initialized by user and must not be removed from start up sequence. Default value is random.
0xC339	COLOR_MATRIX_S_5_2	–	RW	Bit[7:0]: Short color matrix 5[7:0] This register value must be initialized by user and must not be removed from start up sequence. Default value is random.
0xC33A	COLOR_MATRIX_S_6_1	–	RW	Bit[7:0]: Short color matrix 6[15:8] This register value must be initialized by user and must not be removed from start up sequence. Default value is random.
0xC33B	COLOR_MATRIX_S_6_2	–	RW	Bit[7:0]: Short color matrix 6[7:0] This register value must be initialized by user and must not be removed from start up sequence. Default value is random.
0xC33C	COLOR_MATRIX_S_7_1	–	RW	Bit[7:0]: Short color matrix 7[15:8] This register value must be initialized by user and must not be removed from start up sequence. Default value is random.
0xC33D	COLOR_MATRIX_S_7_2	–	RW	Bit[7:0]: Short color matrix 7[7:0] This register value must be initialized by user and must not be removed from start up sequence. Default value is random.
0xC33E	COLOR_MATRIX_S_8_1	–	RW	Bit[7:0]: Short color matrix 8[15:8] This register value must be initialized by user and must not be removed from start up sequence. Default value is random.
0xC33F	COLOR_MATRIX_S_8_2	–	RW	Bit[7:0]: Short color matrix 8[7:0] This register value must be initialized by user and must not be removed from start up sequence. Default value is random.
0xC340	COLOR_MATRIX_S_9_1	–	RW	Bit[7:0]: Short color matrix 9[15:8] This register value must be initialized by user and must not be removed from start up sequence. Default value is random.

table 5-10 CMX control registers (sheet 6 of 6)

address	register name	default value	R/W	description
0xC341	COLOR_MATRIX_S_9_2	–	RW	Bit[7:0]: Short color matrix 9[7:0] This register value must be initialized by user and must not be removed from start up sequence. Default value is random.
0xC342	COLOR_MATRIX_S_10_1	–	RW	Bit[7:0]: Short color matrix 10[15:8] This register value must be initialized by user and must not be removed from start up sequence. Default value is random.
0xC343	COLOR_MATRIX_S_10_2	–	RW	Bit[7:0]: Short color matrix 10[7:0] This register value must be initialized by user and must not be removed from start up sequence. Default value is random.
0xC344	COLOR_MATRIX_S_11_1	–	RW	Bit[7:0]: Short color matrix 11[15:8] This register value must be initialized by user and must not be removed from start up sequence. Default value is random.
0xC345	COLOR_MATRIX_S_11_2	–	RW	Bit[7:0]: Short color matrix 11[7:0] This register value must be initialized by user and must not be removed from start up sequence. Default value is random.
0xC346	COLOR_MATRIX_S_12_1	–	RW	Bit[7:0]: Short color matrix 12[15:8] This register value must be initialized by user and must not be removed from start up sequence. Default value is random.
0xC347	COLOR_MATRIX_S_12_2	–	RW	Bit[7:0]: Short color matrix 12[7:0] This register value must be initialized by user and must not be removed from start up sequence. Default value is random.

5.7 auto color saturation

The auto color saturation block can adjust the color saturation level based on the sensor gain. Thus, in low light, when the gain setting is high, the color saturation can be reduced to effectively reduce spatial noise in the scene (i.e., resulting image will lose some color saturation but will be less noisy). In bright conditions, when gain is low and noise is also relatively low, the color saturation will be at a high level.

figure 5-5 auto color saturation graph

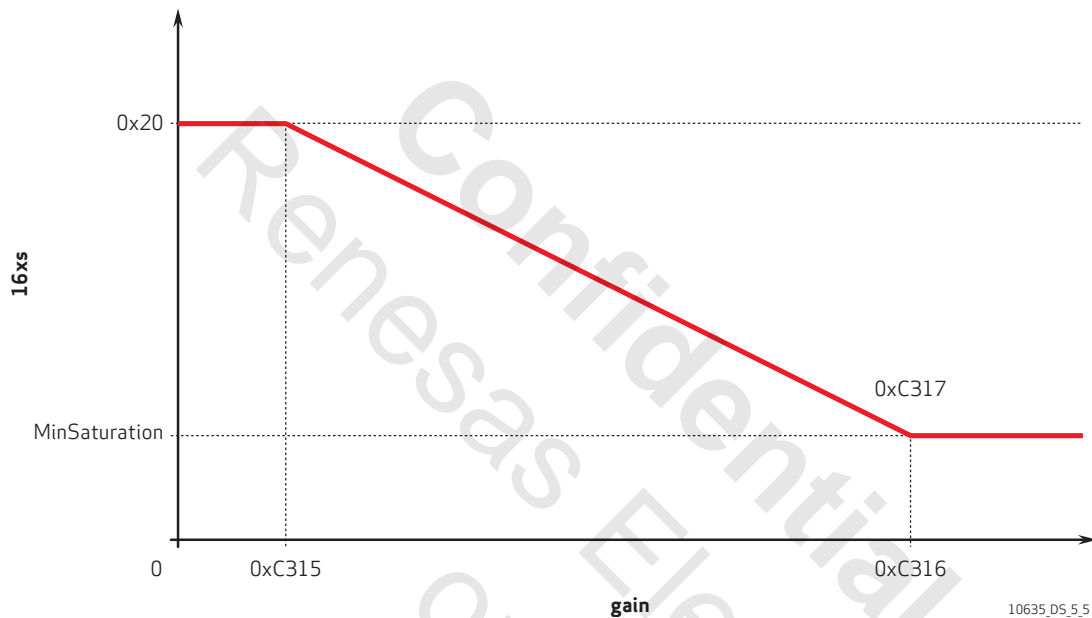

table 5-11 auto color saturation control registers (sheet 1 of 2)

address	register name	default value	R/W	description
0xC314	SATURATION_ADJ_EN	–	RW	Bit[1:0]: Saturation adjust enable 00: Keep previous saturation 01: Auto adjust color saturation 10: Keep minimum saturation 11: Keep maximum saturation This register value must be initialized by user and must not be removed from start up sequence. Default value is random.

table 5-11 auto color saturation control registers (sheet 2 of 2)

address	register name	default value	R/W	description
0xC315	SATURATION_MINGAIN	–	RW	Minimum Gain To Adjust Color Saturation This register value must be initialized by user and must not be removed from start up sequence. Default value is random.
0xC316	SATURATION_MAXGAIN	–	RW	Maximum Gain To Adjust Color Saturation This register value must be initialized by user and must not be removed from start up sequence. Default value is random.
0xC317	SATURATION_MINTHRE	–	RW	Minimum Threshold When Adjusting Color Saturation This register value must be initialized by user and must not be removed from start up sequence. Default value is random.

5.8 combine

The purpose of the combine block is to combine the long exposure and short exposure channels into a single pixel. The registers define the relative weight of each channel and the overlap.

table 5-12 combine control registers (sheet 1 of 6)

address	register name	default value	R/W	description
0x5001	ISP RW01	1'b1	RW	Bit[0]: Combine enable 0: Disable 1: Enable
0x5400	COMB CTRL0	0x0F	RW	Bit[7:4]: Not used Bit[3]: Dark boost enable 0: Dark boost disable 1: Dark boost enable Bit[2]: combine_uv_weight enable 0: Combine without UV weight 1: Combine with UV weight Bit[1]: color_diff_compensate enable 0: Compensate disable 1: Compensate enable Bit[0]: Compensate error enable 0: Compensate error disable 1: Compensate error enable

table 5-12 combine control registers (sheet 2 of 6)

address	register name	default value	R/W	description
0x5401	COMB CTRL1	0x05	RW	Bit[7:4]: Not used Bit[3:0]: comb_thre_s0 Threshold1 of short channel
0x5402	COMB CTRL2	0x08	RW	Bit[7:4]: Not used Bit[3:0]: comb_thre_s1 Threshold2 of short channel
0x5403	COMB CTRL3	0x0A	RW	Bit[7:4]: Not used Bit[3:0]: comb_thre_s2 Threshold3 of short channel
0x5404	COMB CTRL4	0x09	RW	Bit[7:4]: Not used Bit[3:0]: comb_thre_l0 Threshold1 of long channel
0x5405	COMB CTRL5	0x0A	RW	Bit[7:4]: Not used Bit[3:0]: comb_thre_l1 Threshold2 of long channel
0x5406	COMB CTRL6	0x0A	RW	Bit[3:0]: comb_thre_l2 Threshold3 of long channel
0x5407	COMB CTRL7	0x05	RW	Bit[3:0]: comb_uv_thre_s0 UV threshold1 of short channel
0x5408	COMB CTRL8	0x08	RW	Bit[3:0]: comb_uv_thre_s1 UV threshold2 of short channel
0x5409	COMB CTRL9	0x0A	RW	Bit[3:0]: comb_uv_thre_s2 UV threshold3 of short channel
0x540A	COMB CTRL10	0x09	RW	Bit[3:0]: comb_uv_thre_l0 UV threshold1 of long channel
0x540B	COMB CTRL11	0x0A	RW	Bit[3:0]: comb_uv_thre_l1 UV threshold2 of long channel
0x540C	COMB CTRL12	0x0A	RW	Bit[3:0]: comb_uv_thre_l2 UV threshold3 of long channel
0x540D	COMB CTRL13	0x80	RW	Bit[7:0]: comb_weight00
0x540E	COMB CTRL14	0x80	RW	Bit[7:0]: comb_weight01
0x540F	COMB CTRL15	0x60	RW	Bit[7:0]: comb_weight02
0x5410	COMB CTRL16	0x40	RW	Bit[7:0]: comb_weight03
0x5411	COMB CTRL17	0x80	RW	Bit[7:0]: comb_weight10
0x5412	COMB CTRL18	0x80	RW	Bit[7:0]: comb_weight11
0x5413	COMB CTRL19	0x20	RW	Bit[7:0]: comb_weight12
0x5414	COMB CTRL20	0x10	RW	Bit[7:0]: comb_weight13

table 5-12 combine control registers (sheet 3 of 6)

address	register name	default value	R/W	description
0x5415	COMB CTRL21	0x80	RW	Bit[7:0]: comb_weight20
0x5416	COMB CTRL22	0x80	RW	Bit[7:0]: comb_weight21
0x5417	COMB CTRL23	0x00	RW	Bit[7:0]: comb_weight22
0x5418	COMB CTRL24	0x00	RW	Bit[7:0]: comb_weight23
0x5419	COMB CTRL25	0x80	RW	Bit[7:0]: comb_weight30
0x541A	COMB CTRL26	0x80	RW	Bit[7:0]: comb_weight31
0x541B	COMB CTRL27	0x00	RW	Bit[7:0]: comb_weight32
0x541C	COMB CTRL28	0x00	RW	Bit[7:0]: comb_weight33
0x541D	COMB CTRL29	0x80	RW	Bit[7:0]: comb_uv_weight00
0x541E	COMB CTRL30	0x80	RW	Bit[7:0]: comb_uv_weight01
0x541F	COMB CTRL31	0x80	RW	Bit[7:0]: comb_uv_weight02
0x5420	COMB CTRL32	0x80	RW	Bit[7:0]: comb_uv_weight03
0x5421	COMB CTRL33	0x80	RW	Bit[7:0]: comb_uv_weight10
0x5422	COMB CTRL34	0x80	RW	Bit[7:0]: comb_uv_weight11
0x5423	COMB CTRL35	0x60	RW	Bit[7:0]: comb_uv_weight12
0x5424	COMB CTRL36	0x40	RW	Bit[7:0]: comb_uv_weight13
0x5425	COMB CTRL37	0x80	RW	Bit[7:0]: comb_uv_weight20
0x5426	COMB CTRL38	0x80	RW	Bit[7:0]: comb_uv_weight21
0x5427	COMB CTRL39	0x00	RW	Bit[7:0]: comb_uv_weight22
0x5428	COMB CTRL40	0x00	RW	Bit[7:0]: comb_uv_weight23
0x5429	COMB CTRL41	0x80	RW	Bit[7:0]: comb_uv_weight30
0x542A	COMB CTRL42	0x80	RW	Bit[7:0]: comb_uv_weight31
0x542B	COMB CTRL43	0x00	RW	Bit[7:0]: comb_uv_weight32
0x542C	COMB CTRL44	0x00	RW	Bit[7:0]: comb_uv_weight33
0x542D	COMB CTRL45	0x3C	RW	Debug Mode for Combine

table 5-12 combine control registers (sheet 4 of 6)

address	register name	default value	R/W	description
				Bit[0]: Cut black level 0: Disable 1: Enable
0xC4B4	CUT_BL_EN	–	RW	When register value is 0x00, it means function is disabled; all other values mean function is enabled. This register value must be initialized by user and must not be removed from start up sequence. Default value is random.
				Bit[0]: Dark boost auto switch 0: Disable 1: Enable
0xC4B5	DARKBOOST_AUTO_EN	–	RW	When register value is 0x00, it means function is disabled; all other values mean function is enabled. This register value must be initialized by user and must not be removed from start up sequence. Default value is random.
				Bit[0]: Auto low level 0: Disable 1: Enable
0xC4B6	AUTO_LOW_LEVEL_EN	–	RW	When register value is 0x00, it means function is disabled; all other values mean function is enabled. This register value must be initialized by user and must not be removed from start up sequence. Default value is random.
				Bit[7:0]: Max curve gain[15:8]
0xC4BC	MAX_CURVE_GAIN_1	–	RW	When register value is 0x00, it means function is disabled; all other values mean function is enabled. This register value must be initialized by user and must not be removed from start up sequence. Default value is random.
				Bit[7:0]: Max curve gain[7:0]
0xC4BD	MAX_CURVE_GAIN_2	–	RW	This register value will be automatically initialized by sensor after powering up. Default value is random.

table 5-12 combine control registers (sheet 5 of 6)

address	register name	default value	R/W	description
				Bit[7:0]: Manual gamma[15:8]
0xC4BE	MANUAL_GAMMA_1	–	RW	This register value must be initialized by user and must not be removed from start up sequence. Default value is random.
				Bit[7:0]: Manual gamma[7:0]
0xC4BF	MANUAL_GAMMA_2	–	RW	This register value must be initialized by user and must not be removed from start up sequence. Default value is random.
				Bit[7:0]: Dark boost gain threshold 1[15:8]
0xC4C0	DB_GAIN_THRE_11	–	RW	This register value will be automatically initialized by sensor after powering up. Default value is random.
				Bit[7:0]: Dark boost gain threshold 1[7:0]
0xC4C1	DB_GAIN_THRE_12	–	RW	This register value will be automatically initialized by sensor after powering up. Default value is random.
				Bit[7:0]: Dark boost gain threshold 2[15:8]
0xC4C2	DB_GAIN_THRE_21	–	RW	This register value will be automatically initialized by sensor after powering up. Default value is random.
				Bit[7:0]: Dark boost gain threshold 2[7:0]
0xC4C3	DB_GAIN_THRE_22	–	RW	This register value will be automatically initialized by sensor after powering up. Default value is random.
				Dark Boost Amount
0xC4C4	DB_AMT	–	RW	This register value will be automatically initialized by sensor after powering up. Default value is random.
				Min Dark Boost Amount
0xC4C5	DB_AMT_MIN	–	RW	This register value will be automatically initialized by sensor after powering up. Default value is random.
				Max Dark Boost Amount
0xC4C6	DB_AMT_MAX	–	RW	This register value will be automatically initialized by sensor after powering up. Default value is random.

table 5-12 combine control registers (sheet 6 of 6)

address	register name	default value	R/W	description
0xC4C8	DB_MAX_GAMMA_1	–	RW	Bit[7:0]: Max dark boost gamma[15:8] This register value must be initialized by user and must not be removed from start up sequence. Default value is random.
0xC4C9	DB_MAX_GAMMA_2	–	RW	Bit[7:0]: Max dark boost gamma[7:0] This register value must be initialized by user and must not be removed from start up sequence. Default value is random.
0xC4CA	DARK_TONE_WIDTH_1	–	RW	Bit[7:0]: Dark boost tone width[15:8] This register value must be initialized by user and must not be removed from start up sequence. Default value is random.
0xC4CB	DARK_TONE_WIDTH_2	–	RW	Bit[7:0]: Dark boost tone width[7:0] This register value must be initialized by user and must not be removed from start up sequence. Default value is random.

5.9 normalize

Normalize module is designed to adjust the image contrast. Normalize supports auto and manual mode. In manual mode, the normalize algorithm uses the manual input high level and low level. In auto mode, the algorithm will automatically update the low level and high levels.

table 5-13 normalize control registers (sheet 1 of 2)

address	register name	default value	R/W	description
0x5001	ISP_CTRL1	1'b1	R/W	Bit[1]: Normalize enable 0: Disable normalize 1: Enable normalize
0x5480	NORM RW00	0x21	RW	Bit[7:6]: Not used Bit[5]: Debug mode Bit[4:0]: Step
0x5481	NORM RW01	0x10	RW	Bit[7]: Not used Bit[6:0]: max_low_level 16 ~ 127

table 5-13 normalize control registers (sheet 2 of 2)

address	register name	default value	R/W	description
0x5482	NORM RW02	0xF8	RW	Bit[7:0]: min_low_level -128 to -16, complementary code
0x5483	NORM RW03	0x04	RW	Bit[7]: Not used Bit[6:0]: ps_thres[14:8]
0x5484	NORM RW04	0x00	RW	Bit[7:0]: ps_thres[7:0]

5.10 tone_mapping

The tone-mapping function further adjusts the histogram and contrast.

table 5-14 tone_mapping registers (sheet 1 of 4)

address	register name	default value	R/W	description
0x5001	ISP CTRL01	1'b1	R/W	Bit[2]: tone_mapping enable 0: Disable tone_mapping 1: Enable tone_mapping
0x5500	TOMP RW00	0x03	RW	Bit[7:3]: Not used Bit[2:0]: edge_thre 000: 16 001: 32 010: 64 011: 128 100: 256 101: 512
0x5501	TOMP RW01	0x3A	RW	Bit[7:6]: Not used Bit[5]: h_dark_en Bit[4]: uv_dark_en Bit[3:2]: h_dark_thre 00: 16 01: 32 10: 48 11: 64 Bit[1:0]: uv_dark_thre 00: 16 01: 32 10: 48 11: 64
0x5509	TOMP RW09	0x00	RW	Bit[7:0]: max_dynamic_range[7:0]
0x550A	TOMP RW10	0x00	RW	Bit[7:0]: dbg_ctrl_0

table 5-14 tone_mapping registers (sheet 2 of 4)

address	register name	default value	R/W	description
0x550B	TOMP RW11	0x00	RW	Bit[7:0]: dbg_ctrl_1
0x550C	TOMP RW12	0x00	RW	Bit[7:0]: dbg_ctrl_2
0x550D	TOMP RW13	0x00	RW	Bit[7:1]: Not used Bit[0]: dbg_sram_freeze
0x550E	TOMP RW14	0x00	RW	Bit[7:0]: dbg_addr
				Contrast Curve 1
0xC4E4	CONTRAST_CURVE_1	–	RW	This register value must be initialized by user and must not be removed from start up sequence. Default value is random.
				Contrast Curve 2
0xC4E5	CONTRAST_CURVE_2	–	RW	This register value must be initialized by user and must not be removed from start up sequence. Default value is random.
				Contrast Curve 3
0xC4E6	CONTRAST_CURVE_3	–	RW	This register value must be initialized by user and must not be removed from start up sequence. Default value is random.
				Contrast Curve 4
0xC4E7	CONTRAST_CURVE_4	–	RW	This register value must be initialized by user and must not be removed from start up sequence. Default value is random.
				Contrast Curve 5
0xC4E8	CONTRAST_CURVE_5	–	RW	This register value must be initialized by user and must not be removed from start up sequence. Default value is random.
				Contrast Curve 6
0xC4E9	CONTRAST_CURVE_6	–	RW	This register value must be initialized by user and must not be removed from start up sequence. Default value is random.
				Contrast Curve 7
0xC4EA	CONTRAST_CURVE_7	–	RW	This register value must be initialized by user and must not be removed from start up sequence. Default value is random.

table 5-14 tone_mapping registers (sheet 3 of 4)

address	register name	default value	R/W	description
				Contrast Curve 8
0xC4EB	CONTRAST_CURVE_8	–	RW	This register value must be initialized by user and must not be removed from start up sequence. Default value is random.
				Contrast Curve 9
0xC4EC	CONTRAST_CURVE_9	–	RW	This register value must be initialized by user and must not be removed from start up sequence. Default value is random.
				Contrast Curve 10
0xC4ED	CONTRAST_CURVE_10	–	RW	This register value must be initialized by user and must not be removed from start up sequence. Default value is random.
				Contrast Curve 11
0xC4EE	CONTRAST_CURVE_11	–	RW	This register value must be initialized by user and must not be removed from start up sequence. Default value is random.
				Contrast Curve 12
0xC4EF	CONTRAST_CURVE_12	–	RW	This register value must be initialized by user and must not be removed from start up sequence. Default value is random.
				Contrast Curve 13
0xC4F0	CONTRAST_CURVE_13	–	RW	This register value must be initialized by user and must not be removed from start up sequence. Default value is random.
				Contrast Curve 14
0xC4F1	CONTRAST_CURVE_14	–	RW	This register value must be initialized by user and must not be removed from start up sequence. Default value is random.
				Contrast Curve 15
0xC4F2	CONTRAST_CURVE_15	–	RW	This register value must be initialized by user and must not be removed from start up sequence. Default value is random.
				Curve Adjustment Step
0xC4F3	CURVE_STEP	–	RW	This register value must be initialized by user and must not be removed from start up sequence. Default value is random.

table 5-14 tone_mapping registers (sheet 4 of 4)

address	register name	default value	R/W	description
0xC4F4	CURVE_MIN_DR_1	–	RW	Bit[7:0]: Curve min dynamic range[15:8] This register value must be initialized by user and must not be removed from start up sequence. Default value is random.
0xC4F5	CURVE_MIN_DR_2	–	RW	Bit[7:0]: Curve min dynamic range[7:0] This register value must be initialized by user and must not be removed from start up sequence. Default value is random.
0xC4F6	CURVE_MAX_DR_1	–	RW	Bit[7:0]: Curve max dynamic range[15:8] This register value must be initialized by user and must not be removed from start up sequence. Default value is random.
0xC4F7	CURVE_MAX_DR_2	–	RW	Bit[7:0]: Curve max dynamic range[7:0] This register value must be initialized by user and must not be removed from start up sequence. Default value is random.
0xC4F8	CURVE_MIN_ALPHA	–	RW	Min Curve Alpha This register value must be initialized by user and must not be removed from start up sequence. Default value is random.
0xC4F9	CURVE_MAX_ALPHA	–	RW	Max Curve Alpha This register value must be initialized by user and must not be removed from start up sequence. Default value is random.

5.11 windowing cropping and subsampling

table 5-15 WINC control registers

address	register name	default value	R/W	description
0x5002	ISP CTRL02	1'b1	RW	Bit[2]: winc_en 0: Disable window cropping 1: Enable window cropping
0x5005	ISP RW05	0x08	RW	Bit[7]: Vertical subsampling enable 0: Disable 1: Enable Bit[6]: Lens shading correction center option 0: Manually 1: Automatically Bit[5]: Output row in drop mode of subsampling 0: First row 1: Second row Bit[4]: Output column in drop mode of subsampling 0: First pair 1: Second pair Bit[3]: Average enable in non-drop mode of subsampling 0: Sum 1: Average Bit[2]: Green/Y channel subsampling mode 0: Non-drop 1: Drop Bit[1]: RB/UV channel subsampling mode 0: Non-drop 1: Drop Bit[0]: Subsampling mode enable 0: Full resolution 1: Subsampling

5.12 OTP memory read/write

Since the OTP memory can only be programmed once, the user should be very careful while accessing the OTP. There are total 4 banks 64 bytes OTP, each bank is 16 bytes. The bank select is 0x3D10[5:4], 0 means read/program bank0 only, 1/2/3 means read/program all 4 banks.

5.12.1 procedure to read OTP content

1. Clear software buffer which is used to receive the OTP content.
2. Start video streaming if not yet started.
3. Clear register buffer 0x3D00~0x3D0F and 0x3D30~0x3D5F to 0x00
4. Set register 0x3D10 to 0x00.
5. Set register 0x3D10 to 0x01 or 0x11.
6. Wait 15ms.
7. Read register 0x3D00~0x3D0F and 0x3D30~0x3D5F and set to the software buffer.

The OTP read operation is performed to read back the information stored in OTP memory, to verify the OTP memory is blank before programming data into it, or to verify OTP content after programming data into it.

Verifying the OTP content at the last step of camera module testing is highly recommended in case the OTP content is accidentally overwritten during the module testing.

5.12.2 procedure to program OTP content

1. Follow the above **procedure to read OTP content** to make sure the OTP is blank.
2. Program the intended OTP content to its corresponding register buffer and clear unused register buffers to 0. Registers 0x3D00~0x3D0F and 0x3D30~0x3D5F must be cleared to 0x00 before initiating the OTP programming command.
3. Read back registers 0x3D00~0x3D0F to make sure they contain the correct data to program to OTP memory and 0 for all other bits.
4. Set register 0x3D10 to 0x00 to reset OTP functionality.
5. Write 0x02 or 0x12 to register 0x3D10 to initiate OTP programming.
6. Wait 60ms. Any register access during this period is prohibited.
7. Follow the above **procedure to read OTP content** to read back the OTP content.
8. Compare the OTP content read back to the intended OTP content.

5.12.3 power supply requirement for OTP memory programming

The OTP memory is programmed using the analog power. The AVDD voltage for OTP programming must be $2.5V \pm 10\%$. The power supply should be able to provide extra 50mA for OTP programming.

5.13 group control

The OV10635/OV10135 supports up to four groups. Each group can have up to 128 registers. For group operation, you must first record the group, then write the related register values, and last, set record end.

table 5-16 group control registers

address	register name	default value	R/W	description
0x6F00	GROUP WRITER COMMAND	0x00	RW	Bit[7:6]: Operation code 00: Group record end 01: Group launch (only once) 10: Group launch (ABC mode) 11: Group record start In ABC mode, group0 is for frame A, group1 is for frame B and group2 is for frame C. Three groups launch periodically. Bit[5:4]: Group ID Bit[3:2]: Chip debug Bit[1:0]: Group write function enable, must be 2'b11
0xCFF2	GROUP TABLE0H	0xDD	RW	Group Table0 Start Address MSB
0xCFF3	GROUP TABLE0L	0x00	RW	Group Table0 Start Address LSB
0xCFF6	GROUP TABLE1H	0xDD	RW	Group Table1 Start Address MSB
0xCFF7	GROUP TABLE1L	0x80	RW	Group Table1 Start Address LSB
0xCFFA	GROUP TABLE2H	0xDE	RW	Group Table2 Start Address MSB
0xCFFB	GROUP TABLE2L	0x00	RW	Group Table2 Start Address LSB
0xCFFE	GROUP TABLE3H	0xDE	RW	Group Table3 Start Address MSB
0xCFFF	GROUP TABLE3L	0x80	RW	Group Table3 Start Address LSB

5.14 white/black pixel cancellation (WBC)

The WBC block corrects both black and white defective pixels. The clusters' types and coordinates are saved in the OTP and loaded to memory after power up.

table 5-17 WBC control registers (sheet 1 of 2)

address	register name	default value	R/W	description
0x5002	ISP RW02	0x7E	RW	Bit[7]: OTP manual offset enable 0: Disable 1: Enable Bit[6]: OTP function enable 0: Disable 1: Enable
0x50C1	OTP CTRL L01	0x00	RW	Bit[5:0]: Start address of OTP memory for long channel
0x50C3	OTP CTRL L03	0x00	RW	Bit[5:0]: End address of OTP memory for long channel
0x50C4	OTP CTRL L04	0x02	RW	Bit[5]: Non-HDR mode reverse for long channel Bit[4]: Manual increase step enable for long channel Bit[3]: Disable mirror and flip option for long channel Bit[2]: Disable OTP offset option for long channel Bit[1]: Mirror option for long channel Bit[0]: Disable binning option for long channel
0x50C5	OTP CTRL L05	0x6F	RW	Bit[7:3]: Cluster cancellation option for long channel Bit[2]: Flip option for long channel Bit[1]: Sensor exposure constrain enable for long channel Bit[0]: Sensor gain constrain enable for long channel
0x50C6	OTP CTRL L06	0x00	RW	Bit[7:0]: Exposure constrain[15:8] for long channel
0x50C7	OTP CTRL L07	0x00	RW	Bit[7:0]: Exposure constrain[7:0] for long channel
0x50C8	OTP CTRL L08	0x07	RW	Bit[7:6]: Not used Bit[5:0]: Gain constrain for long channel
0x50C9	OTP CTRL L09	0x08	RW	Bit[7:4]: Not used Bit[3:0]: Recover threshold for long channel
0x50E1	OTP CTRL S01	0x00	RW	Bit[5:0]: Start address of OTP memory for short channel
0x50E3	OTP CTRL S03	0x00	RW	Bit[5:0]: End address of OTP memory for short channel

table 5-17 WBC control registers (sheet 2 of 2)

address	register name	default value	R/W	description
0x50E4	OTP CTRL S04	0x02	RW	Bit[5]: Non-HDR mode reverse for short channel Bit[4]: Manual increase step enable for short channel Bit[3]: Disable mirror and flip option for short channel Bit[2]: Disable OTP offset option for short channel Bit[1]: Mirror option for short channel Bit[0]: Disable binning option for short channel
0x50E5	OTP CTRL S05	0x6F	RW	Bit[7:3]: Cluster cancellation option for short channel Bit[2]: Flip option for short channel Bit[1]: Sensor exposure constrain enable for short channel Bit[0]: Sensor gain constrain enable for short channel
0x50E6	OTP CTRL S06	0x00	RW	Bit[7:0]: Exposure constrain[15:8] for short channel
0x50E7	OTP CTRL S07	0x00	RW	Bit[7:0]: Exposure constrain[7:0] for short channel
0x50E8	OTP CTRL S08	0x07	RW	Bit[5:0]: Gain constrain for short channel
0x50E9	OTP CTRL S09	0x08	RW	Bit[3:0]: Recover threshold for short channel
0x5000	ISP RW00	2'b11	RW	Bit[4]: White defect pixel correction enable 0: Disable 1: Enable Bit[3]: Black defect pixel correction enable 0: Disable 1: Enable
0x5180	WBC CTRL00	0x1C	RW	Bit[7:0]: Debug mode for long exposure sub-pixel
0x5181	WBC CTRL01	0x13	RW	Bit[7:5]: Not used Bit[4]: Debug mode Bit[3:2]: Not used Bit[1:0]: Option for padding boundary pixel for long channel
0x5182~ 0x5191	DEBUG CTRL	–	RW	WBC Debug Control for Long channel
0x5192	WBC CTRL12	0x1C	RW	Bit[7:0]: Debug mode for short channel
0x5193	WBC CTRL13	0x13	RW	Bit[7:5]: Not used Bit[4]: Debug mode Bit[3:2]: Not used Bit[1:0]: Option for padding boundary pixel for short channel
0x5194~ 0x51A3	DEBUG CTRL	–	RW	WBC Debug Control for Short channel

6 image sensor output interface digital functions

6.1 temperature sensor

The OV10635/OV10135 has an embedded temperature sensor to measure junction temperature. This temperature sensor requires a 1-3 MHz clock divided from XVCLK. If XVCLK is 24 MHz, register 0x6706[3:0] must be programmed to 8.

The temperature can be read back from register 0x3827. When the value is below 0xC0, it is the temperature in Celsius. When the value is greater than 0xC0, the temperature is register 0x3827 - 256 in Celsius.

The slope and offset of the temperature sensor is calibrated by an OmniVision production test and the calibration data is stored in OTP. After calibration, the accuracy of the temperature reading is ± 5 degree Celsius over the operating temperature range. When the temperature is out of the operating temperature range, the reading from the temperature sensor is not reliable and is for reference only.

table 6-1 TPM control

address	register name	default value	R/W	description
0x3827	TPM_02	–	R	If 0x3827 < 192, temperature = 0x3827 If 0x3827 \geq 192, temperature = -(256-0x3827)
0x6700	TPM_CTRL0	0x01	RW	TPM_SLOPE0
0x6701	TPM_CTRL1	0xDE	RW	TPM_SLOPE1
0x6702	TPM_CTRL2	0xDE	RW	TPM_OFFSET0
0x6703	TPM_CTRL3	0xDE	RW	TPM_OFFSET1
0x6704	TPM_CTRL4	0xDE	RW	TPM_OFFSET2
0x6705	TPM_CTRL5	0xDE	RW	TPM_OFFSET3
0x6706	TPM_CTRL6	0x71	RW	Bit[7:4]: Chip debug Bit[3:0]: Module clock divider
0x6707	TPM_STALL	0x00	RW	Debug Mode
0x6710~ 0x6721	TPM_DB_NUM	–	R	Debug Information for TPM Control

6.1.1 temperature sensor calibration procedure

The temperature sensor can be calibrated by following these steps:

1. Soak the chip at 50°C (calibration temperature) for twenty minutes in power off state.
2. Power on the camera.
3. Program the temperature calibration settings. This setting minimizes the power consumption by turning on the minimum circuit only. This should be done as quickly as possible to prevent over heating of the sensor.
4. Read out register 0x6E47 and note the value.
5. Following the OTP programming procedure, write this value to the sixth byte of the first bank in the OTP memory.

6.2 embedded line

Embedded line contains register values. The embedded lines are prefixed to the normal image data. The line length of the embedded line is the same as the normal image line. Embedded line only contains register values that are followed with a 0x369 tag (10-bit) or 0xDA tag (8-bit). The 8-bit register values are output D[9:2].

There are two embedded lines. Only the last embedded line contains valid register data for each frame. The first embedded line is a dummy line used to make an even number of lines per frame. Please refer to the *Embedded Line Application Note* for details, and how to customize the embedded line.

table 6-2 embedded line control

address	register name	default value	R/W	description
0x6800	EMB_LINE_EN	0x00	RW	Bit[0]: emb_line enable
0x6801	EMB_LINE_TAG	0xDA	RW	Bit[7:0]: emb_line tag[9:2]
0x6802	EMB_LINE_TAG	0x01	RW	Bit[1:0]: emb_line tag[1:0]
0x6803	EMB_LINE_SOF_CTRL	0x11	RW	Bit[7:4]: s2h_width Bit[3:0]: sof_width
0x6804	EMB_SIZE_MANU_EN	0x00	RW	Bit[0]: emb_size manual enable
0x6805	EMB_SIZE_MANU	0x04	RW	Bit[7:4]: Not used Bit[3:0]: emb_size[11:8]
0x6806	EMB_SIZE_MANU	0x00	RW	Bit[7:0]: emb_size[7:0]
0x6807	EMB_MASK_EN	0x01	RW	Bit[0]: emb_line mask enable

6.3 DVP timing

figure 6-1 DVP timing diagram

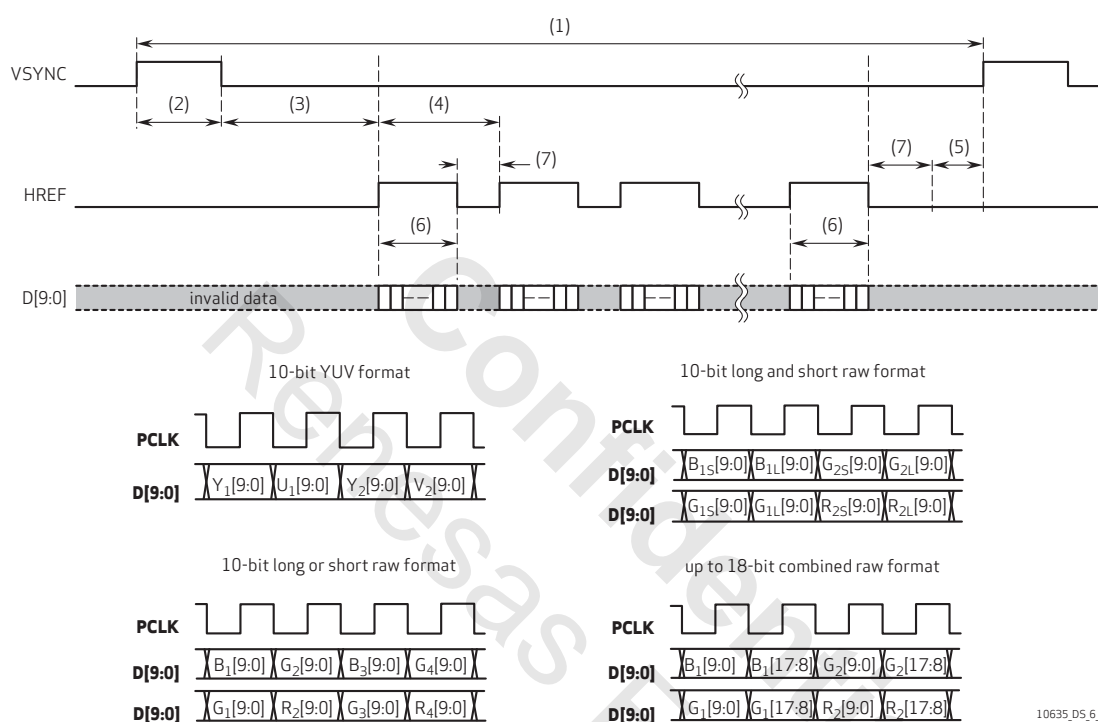

10635_D5_6.1

table 6-3 DVP timing specifications^a (sheet 1 of 3)

resolution	parameter	format			
		YUV	combined RAW	long and short RAW	long or short RAW
1280x800	(1) frame period	840 lines	840 lines	840 lines	840 lines
	(2) VSYNC width	128.5 t _p	128.5 t _p	128.5 t _p	257 t _p
	(3) VSYNC to HREF	30758.5 t _p	30750.5 t _p	26906.5 t _p	27005 t _p
	(4) line period	1905 t _p	1905 t _p	1905 t _p	1905 t _p
	(5) HREF to VSYNC	45313 t _p	45321 t _p	49165 t _p	48938 t _p
	(6) active pixel	1280 t _p	1280 t _p	1280 t _p	1280 t _p
	(7) horizontal blanking	625 t _p	625 t _p	625 t _p	625 t _p

table 6-3 DVP timing specifications^a (sheet 2 of 3)

resolution	parameter	format			
		YUV	combined RAW	long and short RAW	long or short RAW
1280x720	(1) frame period	748 lines	748 lines	748 lines	748 lines
	(2) VSYNC width	128.5 t _p	128.5 t _p	128.5 t _p	257 t _p
	(3) VSYNC to HREF	28760.5 t _p	28752.5 t _p	25154.5 t _p	25223 t _p
	(4) line period	1782 t _p	1782 t _p	1782 t _p	1782 t _p
	(5) HREF to VSYNC	21007 t _p	21015 t _p	24613 t _p	24416 t _p
	(6) active pixel	1280 t _p	1280 t _p	1280 t _p	1280 t _p
	(7) horizontal blanking	502 t _p	502 t _p	502 t _p	502 t _p
752x480	(1) frame period	520 lines	520 lines	520 lines	520 lines
	(2) VSYNC width	128.5 t _p	128.5 t _p	128.5 t _p	257 t _p
	(3) VSYNC to HREF	20660.5 t _p	20746.5 t _p	18148.5 t _p	18021 t _p
	(4) line period	1282 t _p	1282 t _p	1282 t _p	1282 t _p
	(5) HREF to VSYNC	30491 t _p	30405 t _p	33003 t _p	33002 t _p
	(6) active pixel	752 t _p	752 t _p	752 t _p	752 t _p
	(7) horizontal blanking	530 t _p	530 t _p	530 t _p	530 t _p
640x480	(1) frame period	520 lines	520 lines	520 lines	520 lines
	(2) VSYNC width	128.5 t _p	128.5 t _p	128.5 t _p	257 t _p
	(3) VSYNC to HREF	20636.5 t _p	20694.5 t _p	18096.5 t _p	17969 t _p
	(4) line period	1282 t _p	1282 t _p	1282 t _p	1282 t _p
	(5) HREF to VSYNC	30515 t _p	30457 t _p	33055 t _p	33054 t _p
	(6) active pixel	640 t _p	640 t _p	640 t _p	640 t _p
	(7) horizontal blanking	642 t _p	642 t _p	642 t _p	642 t _p
640x400	(1) frame period	438 lines			
	(2) VSYNC width	128.5 t _p			
	(3) VSYNC to HREF	14701 t _p			
	(4) line period	914 t _p			
	(5) HREF to VSYNC	19902.5 t _p			
	(6) active pixel	640 t _p			
	(7) horizontal blanking	274 t _p			

table 6-3 DVP timing specifications^a (sheet 3 of 3)

resolution	parameter	format			
		YUV	combined RAW	long and short RAW	long or short RAW
352x288	(1) frame period	328 lines			
	(2) VSYNC width	128.5 t_p			
	(3) VSYNC to HREF	9748 t_p			
	(4) line period	618 t_p			
	(5) HREF to VSYNC	14443.5 t_p			
	(6) active pixel	352 t_p			
	(7) horizontal blanking	256 t_p			
320x240	(1) frame period	280 lines			
	(2) VSYNC width	128.5 t_p			
	(3) VSYNC to HREF	7040 t_p			
	(4) line period	440 t_p			
	(5) HREF to VSYNC	10431.5 t_p			
	(6) active pixel	320 t_p			
	(7) horizontal blanking	120 t_p			

a. These parameters change with register settings. They are different with different register settings.

6.3.1 DVP setup/hold time

figure 6-2 DVP setup/hold time diagram

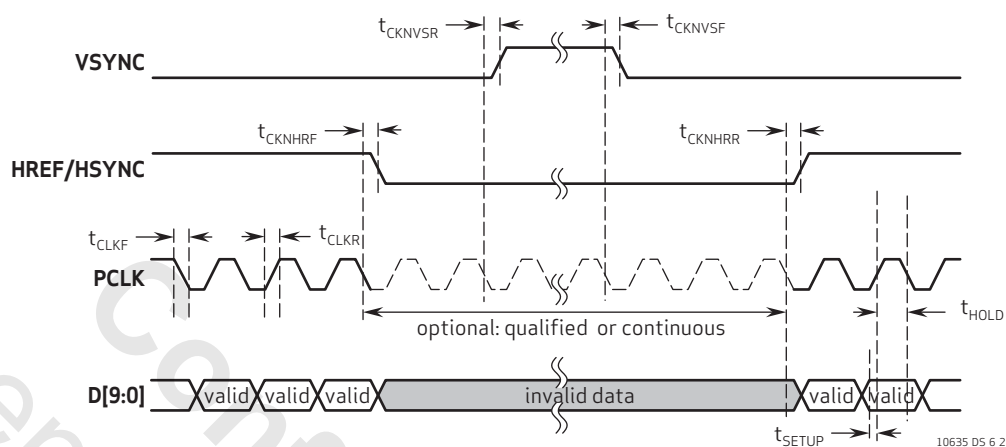
table 6-4 DVP setup/hold time^{ab}

symbol	parameter	min	typ	max	unit
t_{CKNVSR}	PCLK falling edge to VSYNC rising edge delay	–	0.5	1	ns
t_{CKNVSF}	PCLK falling edge to VSYNC falling edge delay	–	1	1.5	ns
t_{CKNHRF}	PCLK falling edge to HREF falling edge delay	–	0	1	ns
t_{CKNHRR}	PCLK falling edge to HREF rising edge delay	–	-0.5	0.5	ns
t_{CLKF}	PCLK fall time	–	1.2	2.5	ns
t_{CLKR}	PLCK rise time	–	1.8	3.5	ns
t_{SETUP}	data setup time	3	4	–	ns
t_{HOLD}	data hold time	3	5	–	ns

- a. measured at 2.8V DOVDD and 96 MHz PCLK, with 2x drive strength
- b. timing measurement shown at the beginning of the rising edge or/and of the falling edge signifies 10%, timing measurement shown in the middle of the rising/falling edge signifies 50%, timing measurement shown at the beginning of the rising edge or/and of the falling edge signifies 90%

7 register tables

The following table provides a description of the device control registers contained in the OV10635/OV10135. The 7-bit SCCB slave device address is 0x30, the low 3 bits come from GPIO[2:0]/SID[2:0] which is controlled by 0x300C[0].

In order to guarantee reasonable performance, the initialization register sequence must be based on the register settings provided by OmniVision. Contact your local AE for register settings that suit your application.

7.1 system control [0x0100, 0x0103, 0x3000 - 0x3049]

table 7-1 system control registers (sheet 1 of 6)

address	register name	default value	R/W	description
0x0100	STREAM MODE	0x00	RW	Bit[7:1]: Not used Bit[0]: Turn on video stream after power up, always set to "1" 0: Not used 1: Stream on
0x0103	SOFTWARE RESET	0x00	RW	Software Reset will Auto Clear by Itself to 0x00
0x3000	SC_CMMN_PAD_OEN0	0x00	RW	Bit[7:2]: Reserved Bit[1:0]: io_y_oen[9:8]
0x3001	SC_CMMN_PAD_OEN1	0x00	RW	Bit[7:4]: io_y_oen[7:0] Bit[3:0]: Not used
0x3002	SC_CMMN_PAD_OEN2	0x00	RW	Bit[7]: io_vsync_oen Bit[6]: io_href_oen Bit[5]: io_pclk_oen Bit[4]: Reserved Bit[3]: io_strobe_oen Bit[2]: io_sda_oen Bit[1]: io_gpio1_oen Bit[0]: io_gpio0_oen
0x3003	SC_CMMN_PLL_CTRL0	0x20	RW	Bit[7:6]: SCLK PLL cp[1:0] Bit[5:0]: SCLK PLL multi
0x3004	SC_CMMN_PLL_CTRL1	0x00	RW	Bit[7]: Bypass SCLK PLL Bit[6:4]: SCLK PLL pre div Bit[3]: SCLK PLL cp[2] Bit[2:0]: SCLK PLL sdiv
0x3005	SC_CMMN_PLL_CTRL2	0x20	RW	Bit[7:6]: PCLK PLL cp[1:0] Bit[5:0]: PCLK PLL multi

table 7-1 system control registers (sheet 2 of 6)

address	register name	default value	R/W	description
0x3006	SC_CMMN_PLL_CTRL3	0x00	RW	Bit[7]: Bypass PCLK PLL Bit[6:4]: PCLK PLL pre div Bit[3]: PCLK PLL cp[2] Bit[2:0]: PCLK PLL sdiv
0x3007	SC_CMMN_PCLK_DIV_CTRL	0x01	RW	Bit[7:0]: Debug mode
0x3008	SC_CMMN_PAD_OUT0	0x00	RW	Bit[7:2]: Reserved Bit[1:0]: io_y_o[9:8]
0x3009	SC_CMMN_PAD_OUT1	0x00	RW	Bit[7:0]: io_y_o[7:0]
0x300A	PID	0xA6	R	Product ID Number MSB (Read only)
0x300B	VER	0x35	R	Product ID Number LSB (Read only)
0x300C	SC_CMMN_SCCB_ID	0x60	RW	Bit[7:1]: SCCB ID Bit[0]: SCCB ID select 0: {sccb_id[7:4],gpio_i[3:1]} 1: sccb_id[7:1]
0x300D	SC_CMMN_PAD_OUT2	0x00	RW	Bit[7]: io_vsync_o Bit[6]: io_href_o Bit[5]: io_pclk_o Bit[4:0]: Reserved
0x300E	SC_CMMN_PAD_SEL0	0x00	RW	Bit[7:2]: Reserved Bit[1:0]: io_y_sel[9:8]
0x300F	SC_CMMN_PAD_SEL1	0x00	RW	Bit[7:0]: io_y_sel[7:0]
0x3010	SC_CMMN_PAD_SEL2	0x00	RW	Bit[7]: io_vsync_sel Bit[6]: io_href_sel Bit[5]: io_pclk_sel Bit[4:0]: Reserved
0x3011	SC_CMMN_PAD	0x02	RW	Bit[7:6]: Pad drive strength Bit[5:0]: Reserved
0x3012	SC_CMMN_SENSOR_GATE_CTRL	0x00	RW	Bit[7]: Sensor gate BLC enable Bit[6]: Sensor gate ISP enable Bit[5]: Not used Bit[4]: Sensor gate VFIFO enable Bit[3]: Sensor gate DVP enable Bit[2:1]: Not used Bit[0]: Sensor gate OTP enable
0x3016~ 0x3019	SC_CMMN_CTRL	–	RW	Bit[7:0]: Debug mode

table 7-1 system control registers (sheet 3 of 6)

address	register name	default value	R/W	description
0x301A	SC_CMMN_CLKRST0	0x70	RW	Bit[7:6]: Reserved Bit[5]: sclk_ac Bit[4]: sclk_tc Bit[3:2]: Reserved Bit[1]: rst_ac Bit[0]: rst_tc
0x301B	SC_CMMN_CLKRST1	0xB4	RW	Bit[7]: sclk_blc Bit[6]: sclk_isp Bit[5]: Chip debug Bit[4]: sclk_vfifo Bit[3]: rst_blc Bit[2]: rst_isp Bit[1]: Chip debug Bit[0]: rst_vfifo
0x301C	SC_CMMN_CLKRST2	0xF0	RW	Bit[7]: pclk_dvp Bit[6:5]: Chip debug Bit[4]: sclk_otp Bit[3]: rst_dvp Bit[2:1]: Chip debug Bit[0]: rst_otp
0x301D	SC_CMMN_CLKRST3	0xB4	RW	Bit[7]: sclk2x_isp Bit[6:5]: Chip debug Bit[4]: sclk_aec_pk Bit[3:1]: Chip debug Bit[0]: rst_aec_pk
0x301E	SC_CMMN_CLKRST4	0xF0	RW	Bit[7:6]: Chip debug Bit[5]: pclk_vfifo Bit[4:2]: Chip debug Bit[1:0]: Reserved
0x301F	SC_CMMN_FREX_RST_MASK0	0x00	RW	Bit[7:0]: Reserved
0x3020	SC_CMMN_CLOCK_SEL	0x0B	RW	Bit[7]: Not used Bit[6:1]: Chip debug Bit[0]: sclk2x option 0: Select from 1x system clock 1: Select from 2x system clock
0x3021	SC_CMMN_MISC_CTRL	0x03	RW	Bit[7]: pclk_inv enable Bit[6]: sclk_inv enable Bit[5]: sclk2x_inv enable Bit[4:1]: Reserved Bit[0]: cen_global_o
0x3022	SC_CMMN_CORE_CTRL	0x00	RW	Bit[7:0]: Chip debug

table 7-1 system control registers (sheet 4 of 6)

address	register name	default value	R/W	description
0x3023	SC_CMMN_CORE_CTRL	0x00	RW	Bit[7:6]: Chip debug Bit[5]: bist_en Bit[4]: Clock switch 0: Switch all clock to pad clock 1: Switch from pad clock to all clock Bit[3:0]: Chip debug
0x3024	SC_CMMN_CORE_CTRL	0x04	RW	Bit[7:6]: Chip debug Bit[5:4]: RAW mode 00: Long 01: Short 10: Long, short 11: Combined Bit[3]: Debug mode Bit[2:1]: YUV mode 00: HDR 01: Long 10: Short 11: Not allowed Bit[0]: PCLK PLL disable 0: PCLK from secondary PLL 1: PCLK from system clock
0x3025	SC_CMMN_CORE_CTRL1	0x00	RW	Bit[7:0]: Chip debug
0x3028	SC_CMMN_BIST_EN	0x00	RW	Chip Debug
0x3029	SC_CMMN_BIST_EN	0x00	RW	Bit[7:0]: Debug control
0x302A	SC_CMMN_SB_ID	0xF1	R	Chip Subversion ID
0x302B	SC_CMMN_RS232_ID	0xFE	RW	Chip Debug
0x302C	SC_CMMN_PWDN_CTRL1	0x00	RW	Chip Debug
0x302D	SC_CMMN_PWDN_CTRL2	0x2F	RW	Chip Debug
0x302E	SC_CMMN_FSIN_EN	0x00	RW	Bit[7:1]: Not used Bit[0]: FSIN enable
0x302F	SC_CMMN_GPIO01	0x88	RW	Bit[7]: gpio0_sel Bit[6]: gpio0_dir Bit[5]: gpio0_out Bit[4]: Chip debug Bit[3]: gpio1_sel Bit[2]: gpio1_dir Bit[1]: gpio1_out Bit[0]: Chip debug

table 7-1 system control registers (sheet 5 of 6)

address	register name	default value	R/W	description
0x3030	SC_CMMN_GPIO23	0x80	RW	Bit[7]: gpio2_sel Bit[6]: gpio2_dir Bit[5]: gpio2_out Bit[4]: Chip debug Bit[3]: gpio3_sel Bit[2]: gpio3_dir Bit[1]: gpio3_out Bit[0]: Chip debug
0x3031	SC_CMMN_GPIO45	0x00	RW	Bit[7]: gpio4_sel_fsin Bit[6]: gpio4_dir_fsin Bit[5]: gpio4_out Bit[4:0]: Chip debug
0x3032	SC_CMMN_PUMP_CLK_SEL	0x44	RW	Bit[7]: Not used Bit[6:4]: n_pump_ck_sel 000: sclk 001: sclk/2 010: sclk/4 011: sclk/8 100: Pad clock 101: Pad clock/2 110: Pad clock/4 111: Not used Bit[2:0]: p_pump_clk_sel 000: sclk 001: sclk/2 010: sclk/4 011: sclk/8 100: Pad clock 101: Pad clock/2 110: Pad clock/4 111: Not used
0x3033	SC_CMMN_SCLK2X_SEL	0x08	RW	Bit[7:4]: Not used Bit[3:2]: System clock select 00: Reserved 01: System clock/2 10: System clock/4 11: Reserved Bit[1:0]: Reserved
0x3038	SC_CMMN_MAN_ID	0x7F	R	Manufacturer ID High Byte
0x3039	SC_CMMN_MAN_ID	0xA2	R	Manufacturer ID Low Byte
0x303C	SC_CMMN_PWDN	–	R	Bit[7:1]: Not used Bit[0]: Power down signal from pad
0x303D~ 0x303E	RSVD	–	–	Reserved

table 7-1 system control registers (sheet 6 of 6)

address	register name	default value	R/W	description
0x3040	SC_CMMN_CLKRST5	0xF0	RW	Bit[7]: sclk_isp_fc Bit[6]: sclk_fc Bit[5]: Reserved Bit[4]: sclk_fmt Bit[3]: rst_isp_fc Bit[2]: rst_fc Bit[1]: Reserved Bit[0]: rst_fmt
0x3041	SC_CMMN_CLKRST6	0xF0	RW	Chip Debug
0x3042	SC_SOC_CLKRST7	0xF9	RW	Bit[7]: sclk_wb Bit[6]: sclk_dr Bit[5]: sclk_mp Bit[4]: sclk_ct Bit[3]: rst_wb Bit[2]: rst_dr Bit[1]: rst_mp Bit[0]: rst_ct
0x3043	SC_CMMN_FREX_RST_MASK1	0xF0	RW	Bit[7:0]: Reserved
0x3044	SC_CMMN_CTRL44	0x01	RW	Bit[7:0]: Reserved
0x3045	SC_CMMN_PWDN_CTRL_SOC	0x01	RW	Bit[7:1]: Not used Bit[0]: Enable SRB when PWDN
0x3046	SC_CMMN_TIMEOUT	0x00	RW	Bit[7:1]: Not used Bit[0]: Timeout counter enable
0x3047	SC_CMMN_CLKRST8	0x70	RW	Bit[7:0]: Chip debug
0x3048	SC_CMMN_SNR_GATE_CTRL	0x00	RW	Bit[7:0]: Chip debug
0x3049	SC_CMMN_SNR_GATE_CTRL	0x00	RW	Bit[7:0]: Chip debug

7.2 analog control [0x3600 - 0x3603, 0x3610 - 0x3618, 0x3620 - 0x3636]

table 7-2 analog control registers (sheet 1 of 2)

address	register name	default value	R/W	description
0x3600	ANA_ADC1	0x54	RW	ADC Control 1
0x3601	ANA_ADC2	0x03	RW	ADC Control 2
0x3602	ANA_ADC3	0x2F	RW	ADC Control 3

table 7-2 analog control registers (sheet 2 of 2)

address	register name	default value	R/W	description
0x3603	ANA_ADC4	0x00	RW	ADC Control 4
0x3610	ANA_ANALOG1	0x2C	RW	Analog Control 1
0x3611	ANA_ANALOG2	0x66	RW	Analog Control 2
0x3612	ANA_ANALOG3	0xE8	RW	Analog Control 3
0x3613	ANA_ANALOG4	0x01	RW	Analog Control 4
0x3614	ANA_ANALOG5	0x00	RW	Analog Control 5
0x3615	ANA_ANALOG6	0x00	RW	Analog Control 6
0x3616~ 0x3618	ANA_ANALOG7	0x00	RW	Debug Registers
0x3620	ANA_ARRAY2	0x88	RW	Array Readout Control 2
0x3621	ANA_ARRAY1	0x03	RW	Array Readout Control 1
0x3630	ANA_PWC1	0x00	RW	Power/Reference Control 1
0x3631	ANA_PWC2	0x14	RW	Power/Reference Control 2
0x3632	ANA_PWC3	0x40	RW	Power/Reference Control 3
0x3633	ANA_PWC4	0xBA	RW	Power/Reference Control 4
0x3634	ANA_PWC5	0xB2	RW	Power/Reference Control 5
0x3635	ANA_PWC6	0x01	RW	Power/Reference Control 6
0x3636	TPM_CTRL	0x00	RW	Chip Debug

7.3 sensor control [0x3700 - 0x3710, 0x3712 - 0x374F]

table 7-3 sensor control registers (sheet 1 of 2)

address	register name	default value	R/W	description
0x3700	SENSOR_REG00	0x22	RW	Timing Control 1
0x3701	SENSOR_CTRL01	0x28	RW	Timing Control 2
0x3702	SENSOR_RSTGOLOW	0x20	RW	Timing Control 3
0x3703	SENSOR_HLDWIDTH	0x32	RW	Timing Control 4

table 7-3 sensor control registers (sheet 2 of 2)

address	register name	default value	R/W	description
0x3704	SENSOR_TXWIDTH	0x32	RW	Timing Control 5
0x3705	SENSOR_REG05	0x61	RW	Timing Control 6
0x3706	SENSOR_REG06	0x11	RW	Debug Mode
0x3707	SENSOR_REG7	0x03	RW	Timing Control 7
0x3708	SENSOR_REG8	0x00	RW	Timing Control 8
0x3709	SENSOR_REG9	0x28	RW	Timing Control 9
0x370A	SENSOR_REGA	0x00	RW	Timing Control 0A
0x370B	SENSOR_REGB	0x11	RW	Timing Control 0B
0x370C	SENSOR_REGC	0x07	RW	Timing Control 0C
0x370D	SENSOR_REGD	0x00	RW	Timing Control 0D
0x370E	SENSOR_REGE	0x10	RW	Debug Mode
0x370F	SENSOR_REGF	0x40	RW	Debug Mode
0x3710	SENSOR_REG10	0x33	RW	Timing Control 10
0x3712	SENSOR_RSTYZ_GLOW	0x00	RW	Timing Control 12
0x3713	SENSOR_RSTYZ_GLOW	0x20	RW	Timing Control 13
0x3714	SENSOR_EQ_GLOW	0x08	RW	Timing Control 14
0x3715	SENSOR_REG15	0x04	RW	Timing Control 15
0x3716~ 0x374F	SENSOR DEBUG	0x03	RW	Chip Debug

7.4 timing control [0x3800 - 0x382B, 0x3832 - 0x3835, 0x3844, 0x3848 - 0x3849]

table 7-4 timing control registers (sheet 1 of 4)

address	register name	default value	R/W	description
0x3800	TIMING_X_START_ADDR	0x00	RW	Manual Horizontal Start Address of Array for Readout High Byte

table 7-4 timing control registers (sheet 2 of 4)

address	register name	default value	R/W	description
0x3801	TIMING_X_START_ADDR	0x00	RW	Manual Horizontal Start Address of Array for Readout Low Byte
0x3802	TIMING_Y_START_ADDR	0x00	RW	Vertical Start Address of Array for Readout High Byte
0x3803	TIMING_Y_START_ADDR	0x00	RW	Vertical Start Address of Array for Readout Low Byte
0x3804	TIMING_X_END_ADDR	0x05	RW	Manual Horizontal End Address of Array for Readout High Byte
0x3805	TIMING_X_END_ADDR	0x0F	RW	Manual Horizontal End Address of Array for Readout Low Byte
0x3806	TIMING_Y_END_ADDR	0x03	RW	Vertical End Address of Array for Readout High Byte
0x3807	TIMING_Y_END_ADDR	0x28	RW	Vertical End Address of Array for Readout Low Byte
0x3808	TIMING_X_OUTPUT_SIZE	0x05	RW	DVP Horizontal Output Size (Pixel) High Byte
0x3809	TIMING_X_OUTPUT_SIZE	0x00	RW	DVP Horizontal Output Size (Pixel) Low Byte
0x380A	TIMING_Y_OUTPUT_SIZE	0x03	RW	DVP Vertical Output Size (Pixel) High Byte
0x380B	TIMING_Y_OUTPUT_SIZE	0x20	RW	DVP Vertical Output Size (Pixel) Low Byte
0x380C	TIMING_HTS	0x07	RW	Horizontal Total Size High Byte
0x380D	TIMING_HTS	0x70	RW	Horizontal Total Size Low Byte
0x380E	TIMING_VTS	0x03	RW	Vertical Total Size High Byte
0x380F	TIMING_VTS	0x48	RW	Vertical Total Size Low Byte
0x3810	TIMING_ISP_X_WIN	0x00	RW	ISP Horizontal Windowing Start Address High Byte
0x3811	TIMING_ISP_X_WIN	0x00	RW	ISP Horizontal Windowing Start Address Low Byte
0x3812	TIMING_ISP_Y_WIN	0x00	RW	ISP Vertical Windowing Start Address High Byte
0x3813	TIMING_ISP_Y_WIN	0x00	RW	ISP Vertical Windowing Start Address Low Byte
0x3815	TIMING_CTRL15	0x8C	RW	Bit[7]: Black line HREF enable Bit[6]: Reserved Bit[5]: Rip SOF enable Bit[4]: Horizontal crop manual enable Bit[3:0]: Black lines number
0x3817	TIMING_CTRL17	0x00	RW	Bit[7:4]: Vertical start line number for tc_sof Bit[3:0]: Debug mode

table 7-4 timing control registers (sheet 3 of 4)

address	register name	default value	R/W	description
0x3819	TIMING_CTRL19	0x00	RW	Bit[7:4]: DVP SOF delay control Bit[3]: BLC vflip Bit[2]: Enable use of left black line to do BLC Bit[1:0]: Debug control
0x381C	TIMING_CTRL1C	0x00	RW	Bit[7]: Vflip to digital Bit[6]: Vflip in array Bit[5:2]: Chip debug Bit[1]: Vsub4 Bit[0]: Vsub2
0x381D	TIMING_CTRL1D	0x40	RW	Bit[7]: Debug mode Bit[6]: hdr_en Bit[5:2]: Not used Bit[1]: Mirror to digital Bit[0]: Mirror to array
0x381E	V_START_H	0x00	RW	Vertical Start Offset High Byte
0x381F	V_START_L	0x0C	RW	Vertical Start Offset Low Byte
0x3820~ 0x3823	TIMING_GRP	–	RW	Chip Debug
0x3824	TIMING_CTRL24	0x00	RW	Bit[7]: Not used Bit[6]: High temperature AWB disable Bit[5]: Chip debug Bit[3]: Use big size embedded table Bit[2:0]: Chip debug
0x3825	MIN_FRAME	0x01	RW	Bit[7:2]: Not used Bit[1:0]: Min frame rate when in night mode 00: Insert one frame 01: Insert two frame 10: Insert three frame 11: Debug mode
0x3826	TIMING_CTRL26	0x00	RW	Chip Debug
0x3827	TEMPERATURE SENSOR	--	R	Temperature Read Value
0x3828	TIMING_CTRL28	0x00	RW	Bit[7:2]: Chip debug Bit[1]: ISP manual target enable for long channel Bit[0]: ISP manual target enable for short channel
0x3829	TIMING_CTRL29	0x01	RW	ISP Manual Target For Long Channel
0x382A	TIMING_CTRL2A	0x00	RW	ISP Manual Target For Short Channel
0x382B	AWB_HT_RANGE	0x00	RW	Bit[7:0]: AWB normal range
0x3832	TIMING_TC_CS_RST	0x00	RW	Horizontal Counter Reset Value High Byte

table 7-4 timing control registers (sheet 4 of 4)

address	register name	default value	R/W	description
0x3833	TIMING_TC_CS_RST	0x00	RW	Horizontal Counter Reset Value Low Byte
0x3834	TIMING_TC_R_RST	0x00	RW	Vertical Counter Reset Value (vts - tc_r_rst) High Byte
0x3835	TIMING_TC_R_RST	0x10	RW	Vertical Counter Reset Value (vts - tc_r_rst) Low Byte
0x3844	TIMING_GRP_STS	–	W	Bit[7:4]: Not used Bit[3:0]: Chip debug
0x3848~ 0x3849	TIMING_CTRL	0x00	RW	Frame Counter For Debug

7.5 OTP control [0x3D00 - 0x3D11, 0x3D1F, 0x3D30 - 0x3D5F]

table 7-5 OTP control registers (sheet 1 of 4)

address	register name	default value	R/W	description
0x3D00	OTP_DATA_0	0x00	RW	OTP Dump/load Data Buffer0
0x3D01	OTP_DATA_1	0x00	RW	OTP Dump/load Data Buffer1
0x3D02	OTP_DATA_2	0x00	RW	OTP Dump/load Data Buffer2
0x3D03	OTP_DATA_3	0x00	RW	OTP Dump/load Data Buffer3
0x3D04	OTP_DATA_4	0x00	RW	OTP Dump/load Data Buffer4
0x3D05	OTP_DATA_5	0x00	RW	OTP Dump/load Data Buffer5
0x3D06	OTP_DATA_6	0x00	RW	OTP Dump/load Data Buffer6
0x3D07	OTP_DATA_7	0x00	RW	OTP Dump/load Data Buffer7
0x3D08	OTP_DATA_8	0x00	RW	OTP Dump/load Data Buffer8
0x3D09	OTP_DATA_9	0x00	RW	OTP Dump/load Data Buffer9
0x3D0A	OTP_DATA_A	0x00	RW	OTP Dump/load Data BufferA
0x3D0B	OTP_DATA_B	0x00	RW	OTP Dump/load Data BufferB
0x3D0C	OTP_DATA_C	0x00	RW	OTP Dump/load Data BufferC
0x3D0D	OTP_DATA_D	0x00	RW	OTP Dump/load Data BufferD
0x3D0E	OTP_DATA_E	0x00	RW	OTP Dump/load Data BufferE

table 7-5 OTP control registers (sheet 2 of 4)

address	register name	default value	R/W	description
0x3D0F	OTP_DATA_F	0x00	RW	OTP Dump/load Data BufferF
0x3D10	OTP_MODE	0xC0	RW	Bit[7:6]: Not used Bit[5:4]: Bank select 00: Select bank0 1x: Select all 4 banks Bit[3:2]: Not used Bit[1:0]: opt_mode 00: OTP OFF 01: Load/dump OTP 10: Write/program OTP 11: OTP OFF
0x3D11	OTP_SPEED	0x46	RW	Bit[7]: Not used Bit[6:4]: write_speed Bit[3]: Not used Bit[2:0]: read_speed
0x3D1F	OTP_EF_STATUS	–	R	Bit[7:1]: Not used Bit[0]: otp_busy
0x3D30	OTP_DATA_10	0x00	RW	OTP Dump/load Data Buffer10
0x3D31	OTP_DATA_11	0x00	RW	OTP Dump/load Data Buffer11
0x3D32	OTP_DATA_12	0x00	RW	OTP Dump/load Data Buffer12
0x3D33	OTP_DATA_13	0x00	RW	OTP Dump/load Data Buffer13
0x3D34	OTP_DATA_14	0x00	RW	OTP Dump/load Data Buffer14
0x3D35	OTP_DATA_15	0x00	RW	OTP Dump/load Data Buffer15
0x3D36	OTP_DATA_16	0x00	RW	OTP Dump/load Data Buffer16
0x3D37	OTP_DATA_17	0x00	RW	OTP Dump/load Data Buffer17
0x3D38	OTP_DATA_18	0x00	RW	OTP Dump/load Data Buffer18
0x3D39	OTP_DATA_19	0x00	RW	OTP Dump/load Data Buffer19
0x3D3A	OTP_DATA_1A	0x00	RW	OTP Dump/load Data Buffer1A
0x3D3B	OTP_DATA_1B	0x00	RW	OTP Dump/load Data Buffer1B
0x3D3C	OTP_DATA_1C	0x00	RW	OTP Dump/load Data Buffer1C
0x3D3D	OTP_DATA_1D	0x00	RW	OTP Dump/load Data Buffer1D
0x3D3E	OTP_DATA_1E	0x00	RW	OTP Dump/load Data Buffer1E
0x3D3F	OTP_DATA_1F	0x00	RW	OTP Dump/load Data Buffer1F
0x3D40	OTP_DATA_20	0x00	RW	OTP Dump/load Data Buffer20

table 7-5 OTP control registers (sheet 3 of 4)

address	register name	default value	R/W	description
0x3D41	OTP_DATA_21	0x00	RW	OTP Dump/load Data Buffer21
0x3D42	OTP_DATA_22	0x00	RW	OTP Dump/load Data Buffer22
0x3D43	OTP_DATA_23	0x00	RW	OTP Dump/load Data Buffer23
0x3D44	OTP_DATA_24	0x00	RW	OTP Dump/load Data Buffer24
0x3D45	OTP_DATA_25	0x00	RW	OTP Dump/load Data Buffer25
0x3D46	OTP_DATA_26	0x00	RW	OTP Dump/load Data Buffer26
0x3D47	OTP_DATA_27	0x00	RW	OTP Dump/load Data Buffer27
0x3D48	OTP_DATA_28	0x00	RW	OTP Dump/load Data Buffer28
0x3D49	OTP_DATA_29	0x00	RW	OTP Dump/load Data Buffer29
0x3D4A	OTP_DATA_2A	0x00	RW	OTP Dump/load Data Buffer2A
0x3D4B	OTP_DATA_2B	0x00	RW	OTP Dump/load Data Buffer2B
0x3D4C	OTP_DATA_2C	0x00	RW	OTP Dump/load Data Buffer2C
0x3D4D	OTP_DATA_2D	0x00	RW	OTP Dump/load Data Buffer2D
0x3D4E	OTP_DATA_2E	0x00	RW	OTP Dump/load Data Buffer2E
0x3D4F	OTP_DATA_2F	0x00	RW	OTP Dump/load Data Buffer2F
0x3D50	OTP_DATA_30	0x00	RW	OTP Dump/load Data Buffer30
0x3D51	OTP_DATA_31	0x00	RW	OTP Dump/load Data Buffer31
0x3D52	OTP_DATA_32	0x00	RW	OTP Dump/load Data Buffer32
0x3D53	OTP_DATA_33	0x00	RW	OTP Dump/load Data Buffer33
0x3D54	OTP_DATA_34	0x00	RW	OTP Dump/load Data Buffer34
0x3D55	OTP_DATA_35	0x00	RW	OTP Dump/load Data Buffer35
0x3D56	OTP_DATA_36	0x00	RW	OTP Dump/load Data Buffer36
0x3D57	OTP_DATA_37	0x00	RW	OTP Dump/load Data Buffer37
0x3D58	OTP_DATA_38	0x00	RW	OTP Dump/load Data Buffer38
0x3D59	OTP_DATA_39	0x00	RW	OTP Dump/load Data Buffer39
0x3D5A	OTP_DATA_3A	0x00	RW	OTP Dump/load Data Buffer3A
0x3D5B	OTP_DATA_3B	0x00	RW	OTP Dump/load Data Buffer3B
0x3D5C	OTP_DATA_3C	0x00	RW	OTP Dump/load Data Buffer3C

table 7-5 OTP control registers (sheet 4 of 4)

address	register name	default value	R/W	description
0x3D5D	OTP_DATA_3D	0x00	RW	OTP Dump/load Data Buffer3D
0x3D5E	OTP_DATA_3E	0x00	RW	OTP Dump/load Data Buffer3E
0x3D5F	OTP_DATA_3F	0x00	RW	OTP Dump/load Data Buffer3F

7.6 BLC function [0x4000 - 0x405B, 0xC4B7 - 0xC50F, 0x5B1C - 0x5D30]

table 7-6 BLC function registers (sheet 1 of 11)

address	register name	default value	R/W	description
0x4000	BLC CTRL00	0x09	RW	Bit[7:4]: Not used Bit[3:1]: Chip debug Bit[0]: BLC enable 0: Disable 1: Enable
0x4001	START LINE	0x04	RW	Bit[7:5]: Not used Bit[4:0]: start_line Start line for calculating normal offsets
0x4002	BLC CTRL02	0xC5	RW	Bit[7]: format_change_en 0: Change of format will not trigger BLC 1: Change of format will trigger BLC Bit[6]: offset_auto_en 0: Use manual offsets 1: Use calculated offsets Bit[5:0]: rest_frame_num Number indicates how many frames BLC will be updated continuously when BLC is reset
0x4003	BLC CTRL03	0x08	RW	Bit[7]: trig_man BLC manual trigger signal BLC will update manual_frame_num frames continuously from its rising edge Bit[6]: freeze_en When set, BLC will freeze Bit[5:0]: manual_frame_num Number indicates how many frames BLC will be updated continuously when trig_man is set

table 7-6 BLC function registers (sheet 2 of 11)

address	register name	default value	R/W	description
0x4004	LINE NUM	0x08	RW	Bit[7:5]: Not used Bit[4:0]: line_num Line number specifies black lines used in offsets calculation
0x4005	BLC CTRL05	0x18	R/W	Bit[7:6]: Not used Bit[5]: one_line_mode When set, BLC offsets for B and Gr are the same. Gb and R offsets are the same Bit[4]: remove_black_line 0: Output image includes black lines 1: Output image does not include black lines Bit[3]: one_man_offset_mode When set and manual offsets enable is set, manual offsets for B, Gb, Gr and R are same (first manual offset) Bit[2]: bl_rblue_rvs When set, black lines' rblue signal will be reversed Bit[1]: blc_always_do When set, BLC will always update Bit[0]: Not used
0x4006	NOT USED	-	-	Not Used
0x4007	BLC CTRL07	0x00	R/W	Bit[7:5]: Not used Bit[4:3]: hwin_sel 00: Horizontal size will be full size 01: Horizontal size will exclude 16 left and 16 right pixels 10: Horizontal size will exclude 1/16 left and 1/16 right window of full size 11: Horizontal size will exclude 1/8 left and 1/8 right window of full size Bit[2]: sub128_en When set, output bypass data is subtracted by 128 Bit[1:0]: bypass_mode 00: Output limited input data 01: Output 10 LSBs of input data 1x: Output 10 MSBs of input data
0x4008	LONG BLC TARGET	0x10	R/W	Bit[7:0]: long_blc_target BLC target for long exposure data

table 7-6 BLC function registers (sheet 3 of 11)

address	register name	default value	R/W	description
0x4009	SHORT BLC TARGET	0x10	R/W	Bit[7:0]: short_blc_target BLC target for short exposure data
0x400A~ 0x400B	NOT USED	–	–	Not Used
0x400C	MANUAL OFFSET 00	0x00	R/W	Bit[7:1]: Not used Bit[0]: man_offset00[8] Manual offset for B channel of long exposure data
0x400D	MANUAL OFFSET 00	0x00	R/W	Bit[7:0]: man_offset00[7:0] Manual offset for B channel of long exposure data
0x400E	MANUAL OFFSET 01	0x00	R/W	Bit[7:1]: Not used Bit[0]: man_offset01[8] Manual offset for Gb channel of long exposure data
0x400F	MANUAL OFFSET 01	0x00	RW	Bit[7:0]: man_offset01[7:0] Manual offset for Gb channel of long exposure data
0x4010	MANUAL OFFSET 02	0x00	RW	Bit[7:1]: Not used Bit[0]: man_offset02[8] Manual offset for Gr channel of long exposure data
0x4011	MANUAL OFFSET 02	0x00	RW	Bit[7:0]: man_offset02[7:0] Manual offset for Gr channel of long exposure data
0x4012	MANUAL OFFSET 03	0x00	RW	Bit[7:1]: Not used Bit[0]: man_offset03[8] Manual offset for R channel of long exposure data
0x4013	MANUAL OFFSET 03	0x00	RW	Bit[7:0]: man_offset03[7:0] Manual offset for R channel of long exposure data
0x4014~ 0x4033	NOT USED	–	–	Not Used
0x4034	MANUAL OFFSET 10	0x00	RW	Bit[7:1]: Not used Bit[0]: man_offset10[8] Manual offset for B channel of short exposure data
0x4035	MANUAL OFFSET 10	0x00	RW	Bit[7:0]: man_offset10[7:0] Manual offset for B channel of short exposure data

table 7-6 BLC function registers (sheet 4 of 11)

address	register name	default value	R/W	description
0x4036	MANUAL OFFSET 11	0x00	RW	Bit[7:1]: Not used Bit[0]: man_offset11[8] Manual offset for Gb channel of short exposure data
0x4037	MANUAL OFFSET 11	0x00	RW	Bit[7:0]: man_offset11[7:0] Manual offset for Gb channel of short exposure data
0x4038	MANUAL OFFSET 12	0x00	RW	Bit[7:1]: Not used Bit[0]: man_offset12[8] Manual offset for Gr channel of short exposure data
0x4039	MANUAL OFFSET 12	0x00	RW	Bit[7:0]: man_offset12[7:0] Manual offset for Gr channel of short exposure data
0x403A	MANUAL OFFSET 13	0x00	RW	Bit[7:1]: Not used Bit[0]: man_offset13[8] Manual offset for R channel of short exposure data
0x403B	MANUAL OFFSET 13	0x00	RW	Bit[7:0]: man_offset13[7:0] Manual offset for R channel of short exposure data
0x403C~ 0x404B	NOT USED	–	–	Not Used
0x404C~ 0x404D	TOTAL BLACK LINE NUM	–	R	Debug Information for BLC Control Function
0x404E~ 0x404F	NOT USED	–	–	Not Used
0x4050	BLC AVG CTRL 1	0x20	RW	BLC Average Control 1
0x4051	BLC AVG CTRL 2	0x22	RW	BLC Average Control 2

table 7-6 BLC function registers (sheet 5 of 11)

address	register name	default value	R/W	description
0x4052	BLC CTRL52	0x00	RW	Bit[7:4]: BLC debug control Bit[3]: short_option 0: Short exposure channel will use BLC statistics of short exposure channel 1: Short exposure channel will use BLC statistics of long exposure channel Bit[2]: long_option 0: Long exposure channel will use BLC statistics of long exposure channel 1: Long exposure channel will use BLC statistics of short exposure channel Bit[1]: blc_mid_en 0: Keep black line data 1: Median for black line data Bit[0]: one_channel When set, used offsets will be average of calculated offsets for B, Gb, Gr and R channel
0x4053	BLC CTRL53	0x00	RW	Bit[7:0]: BLC debug control
0x4054	BLC CTRL54	0x00	RW	Bit[7:0]: BLC debug control
0x4055	BLC CTRL55	0xFF	RW	Bit[7]: BLC debug control Bit[6]: short_tmp_chg_en Short channel temperature changing enable signal Bit[5]: short_exp_chg_en Short channel exposure changing enable signal Bit[4]: short_gain_chg_en Short channel gain changing enable signal Bit[3]: long_ana_frz_en Long channel analog freeze enable signal Bit[2]: long_tmp_chg_en Long channel temperature changing enable signal Bit[1]: long_exp_chg_en Long channel exposure changing enable signal Bit[0]: long_gain_chg_en Long channel gain changing enable signal

table 7-6 BLC function registers (sheet 6 of 11)

address	register name	default value	R/W	description
0x4056	OFFSET TOP LIMIT MSB	0x07	RW	BLC Control 1
0x4057	OFFSET TOP LIMIT LSB	0xFF	RW	BLC Control 2
0x4058	OFFSET BOT LIMIT MSB	0x01	RW	BLC Control 3
0x4059	OFFSET BOT LIMIT LSB	0xE0	RW	BLC Control 4
0x405A	BLC CTRL5A	0x70	RW	Bit[7]: Not used Bit[6:0]: BLC debug control
0x405B	BLC CTRL5B	0x00	RW	Bit[7:2]: Not used Bit[1:0]: BLC debug control
0xC4B7	AUTO_BLC_EN	–	RW	Bit[7:1]: Not used Bit[0]: Auto black level cancelling 0: Disable 1: Enable When register value is 0x00, it means function is disabled; all other values mean function is enabled. This register value must be initialized by user and must not be removed from start up sequence. Default value is random.
0xC4E0	BLC_TRIGGE_LIMIT	–	RW	BLC Adjustment Trigger Limitation This register value must be initialized by user and must not be removed from start up sequence. Default value is random.
0xC4E1	BLC_STABLE_LIMIT	–	RW	BLC Adjustment Stable Limitation This register value must be initialized by user and must not be removed from start up sequence. Default value is random.
0xC4E2	BLC_STEP	–	RW	Auto BLC Adjustment Relative Step This register value must be initialized by user and must not be removed from start up sequence. Default value is random.

table 7-6 BLC function registers (sheet 7 of 11)

address	register name	default value	R/W	description
0xC4E3	BLC_PRE_SMOOTH_EN	–	RW	<p>Bit[7:1]: Not used Bit[0]: Smooth offset statistics in first 16 frames 0: Disable 1: Enable</p> <p>When register value is 0x00, it means function is disabled; all other values mean function is enabled. This register value will be automatically initialized by sensor after powering up. Default value is random.</p>
0xC4FA	BLC_HT_OPTION1_EN	–	RW	<p>Bit[7:1]: Not used Bit[0]: High temperature BLC option1 enable Increases stable and slow range Decreases adjustment step 0: Disable 1: Enable</p> <p>When register value is 0x00, it means function is disabled; all other values mean function is enabled. This register value must be initialized by user and must not be removed from start up sequence. Default value is random.</p>
0xC4FB	BLC_HT_OPTION2_EN	–	RW	<p>Bit[7:1]: Not used Bit[0]: High temperature BLC option2 enable Decreases maximum exposure lines 0: Disable 1: Enable</p> <p>When register value is 0x00, it means function is disabled; all other values mean function is enabled. This register value must be initialized by user and must not be removed from start up sequence. Default value is random.</p>

table 7-6 BLC function registers (sheet 8 of 11)

address	register name	default value	R/W	description
0xC4FC	BLC_HT_OPTION3_EN	–	RW	<p>Bit[7:1]: Not used Bit[0]: High temperature BLC option3 enable Switches analog gain to digital gain 0: Disable 1: Enable</p> <p>When register value is 0x00, it means function is disabled; all other values mean function is enabled. This register value must be initialized by user and must not be removed from start up sequence. Default value is random.</p>
0xC4FD	BLC_HT_TEMP_EXP_EN	–	RW	<p>Bit[7:1]: Not used Bit[0]: High temperature BLC temperature limits exposure when option2 is enabled 0: Disable 1: Enable</p> <p>When register value is 0x00, it means function is disabled; all other values mean function is enabled. This register value must be initialized by user and must not be removed from start up sequence. Default value is random.</p>
0xC4FE	BLC_HT_TEMP_MINEXP	–	RW	<p>High Temperature BLC Min Exposure Lines Limited by temperature</p> <p>This register value must be initialized by user and must not be removed from start up sequence. Default value is random.</p>
0xC4FF	BLC_HT_EXPMAXSTEP	–	RW	<p>High Temperature BLC Max Exposure Step</p> <p>This register value must be initialized by user and must not be removed from start up sequence. Default value is random.</p>
0xC500	BLC_HT_TEMP_TH_1L	–	RW	<p>High Temperature BLC Temperature Threshold Long 1</p> <p>This register value must be initialized by user and must not be removed from start up sequence. Default value is random.</p>
0xC501	BLC_HT_TEMP_TH_1S	–	RW	<p>High Temperature BLC Temperature Threshold Short 1</p> <p>This register value must be initialized by user and must not be removed from start up sequence. Default value is random.</p>

table 7-6 BLC function registers (sheet 9 of 11)

address	register name	default value	R/W	description
0xC502	BLC_HT_TEMP_TH_2L	–	RW	High Temperature BLC Temperature Threshold Long 2 This register value must be initialized by user and must not be removed from start up sequence. Default value is random.
0xC503	BLC_HT_TEMP_TH_2S	–	RW	High Temperature BLC Temperature Threshold Short 2 This register value must be initialized by user and must not be removed from start up sequence. Default value is random.
0xC504	BLC_HT_EXP_TH_11	–	RW	Bit[7:0]: High temperature BLC exposure threshold 1 This register value must be initialized by user and must not be removed from start up sequence. Default value is random.
0xC505	BLC_HT_EXP_TH_12	–	RW	Bit[7:0]: High temperature BLC exposure threshold 1 This register value must be initialized by user and must not be removed from start up sequence. Default value is random.
0xC506	BLC_HT_EXP_TH_21	–	RW	Bit[7:0]: High temperature BLC exposure threshold 2 This register value must be initialized by user and must not be removed from start up sequence. Default value is random.
0xC507	BLC_HT_EXP_TH_22	–	RW	Bit[7:0]: High temperature BLC exposure threshold 2 This register value must be initialized by user and must not be removed from start up sequence. Default value is random.
0xC508	BLC_HT_SA1_TH_11	–	RW	Bit[7:0]: High temperature BLC threshold 1 This register value must be initialized by user and must not be removed from start up sequence. Default value is random.

table 7-6 BLC function registers (sheet 10 of 11)

address	register name	default value	R/W	description
0xC509	BLC_HT_SA1_TH_12	–	RW	Bit[7:0]: High temperature BLC threshold 1 This register value must be initialized by user and must not be removed from start up sequence. Default value is random.
0xC50A	BLC_HT_SA1_TH_21	–	RW	Bit[7:0]: High temperature BLC threshold 2 This register value must be initialized by user and must not be removed from start up sequence. Default value is random.
0xC50B	BLC_HT_SA1_TH_22	–	RW	Bit[7:0]: High temperature BLC threshold 2 This register value must be initialized by user and must not be removed from start up sequence. Default value is random.
0xC50C	BLC_HT_SA1_TH_31	–	RW	Bit[7:0]: High temperature BLC threshold 3 This register value must be initialized by user and must not be removed from start up sequence. Default value is random.
0xC50D	BLC_HT_SA1_TH_32	–	RW	Bit[7:0]: High temperature BLC threshold 3 This register value must be initialized by user and must not be removed from start up sequence. Default value is random.
0xC50E	BLC_HT_SA1_TH_41	–	RW	Bit[7:0]: High temperature BLC threshold 4 This register value must be initialized by user and must not be removed from start up sequence. Default value is random.
0xC50F	BLC_HT_SA1_TH_42	–	RW	Bit[7:0]: High temperature BLC threshold 4 This register value must be initialized by user and must not be removed from start up sequence. Default value is random.
0x5B1C~ 0x5B49	BLC_R	–	R	Debug Information for BLC
0x5D1C	BLC_RO01	–	R	Bit[7:3]: Not used Bit[2:0]: long_offset_00[10:8]
0x5D1D	BLC_RO02	0x00	RW	Bit[7:0]: long_offset_00[7:0]
0x5D1E	BLC_RO03	0x00	RW	Bit[7:3]: Not used Bit[2:0]: long_offset_01[10:8]

table 7-6 BLC function registers (sheet 11 of 11)

address	register name	default value	R/W	description
0x5D1F	BLC_RO04	0x00	RW	Bit[7:0]: long_offset_01[7:0]
0x5D20	BLC_RO05	0x00	RW	Bit[7:3]: Not used Bit[2:0]: long_offset_10[10:8]
0x5D21	BLC_RO06	0x00	RW	Bit[7:0]: long_offset_10[7:0]
0x5D22	BLC_RO07	0x00	RW	Bit[7:3]: Not used Bit[2:0]: long_offset_11[10:8]
0x5D23	BLC_RO08	0x00	RW	Bit[7:0]: long_offset_11[7:0]
0x5D24	BLC_RO09	0x00	RW	Bit[7:3]: Not used Bit[2:0]: short_offset_00[10:8]
0x5D25	BLC_RO10	0x00	RW	Bit[7:0]: short_offset_00[7:0]
0x5D26	BLC_RO11	0x00	RW	Bit[7:3]: Not used Bit[2:0]: short_offset_01[10:8]
0x5D27	BLC_RO12	0x00	RW	Bit[7:0]: short_offset_01[7:0]
0x5D28	BLC_RO13	0x00	RW	Bit[7:3]: Not used Bit[2:0]: short_offset_10[10:8]
0x5D29	BLC_RO14	0x00	RW	Bit[7:0]: short_offset_10[7:0]
0x5D2A	BLC_RO15	0x00	RW	Bit[7:3]: Not used Bit[2:0]: short_offset_11[10:8]
0x5D2B	BLC_RO16	0x00	RW	Bit[7:0]: short_offset_11[7:0]
0x5D2C~ 0x5D2F	BLC_RW17~ BLC_RW20	–	–	Debug Information for BLC
0x5D30	BLC_RW21	–	R	Bit[7]: short_ana_freeze Bit[6]: long_ana_freeze Bit[5]: short_tmp_chg Bit[4]: long_tmp_chg Bit[3]: short_exp_chg Bit[2]: long_exp_chg Bit[1]: short_gain_chg Bit[0]: long_gain_chg

7.7 AEC [0x3503, 0x3504, 0x5600 - 0x56EB, 0xC2ED - 0xC51B, 0x5A00 - 0x5C17]

table 7-7 AEC control registers (sheet 1 of 26)

address	register name	default value	R/W	description
0x3503	AEC_PK_MANUAL	0x00	RW	Bit[7:6]: Not used Bit[5]: Gain delay option 0: One frame latch 1: Delay one frame latch Bit[4]: Choose delay option 0: Delay disable 1: Delay enable Bit[3:0]: Not used
0x3504	AEC_PK_MAN_DONE	0x00	RW	Bit[7:1]: Not used Bit[0]: AEC manual done
0x5600	AEC_CTRL00	0x01	RW	Bit[7:2]: Not used Bit[1:0]: Sampling 0x: 2 10: 4 11: 8
0x5601	AEC_CTRL01	0x00	RW	Bit[7:3]: Not used Bit[2:0]: Statwinleft[10:8] Horizontal start point for statistic image
0x5602	AEC_CTRL02	0x00	RW	Bit[7:0]: Statwinleft[7:0] Horizontal start point for statistic image
0x5603	AEC_CTRL03	0x00	RW	Bit[7:2]: Not used Bit[1:0]: Statwintop[9:8] Vertical start point for statistic image
0x5604	AEC_CTRL04	0x04	RW	Bit[7:0]: Statwintop[7:0] Vertical start point for statistic image
0x5605	AEC_CTRL05	0x00	RW	Bit[7:3]: Not used Bit[2:0]: Statwinright[10:8] Horizontal end point for statistic image
0x5606	AEC_CTRL06	0x00	RW	Bit[7:0]: Statwinright[7:0] Horizontal end point for statistic image
0x5607	AEC_CTRL07	0x00	RW	Bit[7:2]: Not used Bit[1:0]: Statwinbottom[9:8] Vertical end point for statistic image
0x5608	AEC_CTRL08	0x08	RW	Bit[7:0]: Statwinbottom[7:0] Vertical end point for statistic image

table 7-7 AEC control registers (sheet 2 of 26)

address	register name	default value	R/W	description
0x5609	AEC CTRL09	0x00	RW	Bit[7:3]: Not used Bit[2:0]: winleft_l[10:8] Horizontal start point to compute weight for long exposure sub-pixel
0x560A	AEC CTRL0A	0x64	RW	Bit[7:0]: winleft_l[7:0] Horizontal start point to calculate weight for long exposure sub-pixel
0x560B	AEC CTRL0B	0x00	RW	Bit[7:3]: Not used Bit[2:0]: winleft_s[10:8] Horizontal start point to calculate weight for short exposure sub-pixel
0x560C	AEC CTRL0C	0x64	RW	Bit[7:0]: winleft_s[7:0] Horizontal start point to calculate weight for short exposure sub-pixel
0x560D	AEC CTRL0D	0x00	RW	Bit[7:2]: Not used Bit[1:0]: wintop_l[9:8] Vertical start point to calculate weight for long exposure sub-pixel
0x560E	AEC CTRL0E	0x4B	RW	Bit[7:0]: wintop_l[7:0] Vertical start point to calculate weight for long exposure sub-pixel
0x560F	AEC CTRL0F	0x00	RW	Bit[7:2]: Not used Bit[1:0]: wintop_s[9:8] Vertical start point to calculate weight for short exposure sub-pixel
0x5610	AEC CTRL10	0x4B	RW	Bit[7:0]: wintop_s[7:0] Vertical start point to calculate weight for short exposure sub-pixel
0x5611	AEC CTRL11	0x00	RW	Bit[7:3]: Not used Bit[2:0]: winwidth_l[10:8] Horizontal width to calculate weight for long exposure sub-pixel
0x5612	AEC CTRL12	0xC8	RW	Bit[7:0]: winwidth_l[7:0] Horizontal width to calculate weight for long exposure sub-pixel
0x5613	AEC CTRL13	0x00	RW	Bit[7:3]: Not used Bit[2:0]: winwidth_s[10:8] Horizontal width to calculate weight for short exposure sub-pixel
0x5614	AEC CTRL14	0xC8	RW	Bit[7:0]: winwidth_s[7:0] Horizontal width to calculate weight for short exposure sub-pixel

table 7-7 AEC control registers (sheet 3 of 26)

address	register name	default value	R/W	description
0x5615	AEC CTRL15	0x00	RW	Bit[7:2]: Not used Bit[1:0]: winheight_l[9:8] Vertical width to calculate weight for long exposure sub-pixel
0x5616	AEC CTRL16	0x96	RW	Bit[7:0]: winheight_l[7:0] Vertical width to calculate weight for long exposure sub-pixel
0x5617	AEC CTRL17	0x00	RW	Bit[7:2]: Not used Bit[1:0]: winheight_s[9:8] Vertical width to calculate weight for long exposure sub-pixel
0x5618	AEC CTRL18	0x96	RW	Bit[7:0]: winheight_s[7:0] Vertical width to calculate weight for long exposure sub-pixel
0x5619	AEC CTRL19	0x00	RW	Bit[7:3]: Not used Bit[2:0]: roileft_l[10:8] Horizontal start point for ROI for long exposure sub-pixel
0x561A	AEC CTRL1A	0x00	RW	Bit[7:0]: roileft_l[7:0] Horizontal start point for ROI for long exposure sub-pixel
0x561B	AEC CTRL1B	0x00	RW	Bit[7:3]: Not used Bit[2:0]: roileft_s[10:8] Horizontal start point for ROI for short exposure sub-pixel
0x561C	AEC CTRL1C	0x00	RW	Bit[7:0]: roileft_s[7:0] Horizontal start point for ROI for short exposure sub-pixel
0x561D	AEC CTRL1D	0x00	RW	Bit[7:2]: Not used Bit[1:0]: roitop_l[9:8] Vertical start point for ROI for long exposure sub-pixel
0x561E	AEC CTRL1E	0x00	RW	Bit[7:0]: roitop_l[7:0] Vertical start point for ROI for long exposure sub-pixel
0x561F	AEC CTRL1F	0x00	RW	Bit[7:2]: Not used Bit[1:0]: roitop_s[9:8] Vertical start point for ROI for short exposure sub-pixel
0x5620	AEC CTRL20	0x00	RW	Bit[7:0]: roitop_s[7:0] Vertical start point for ROI for short exposure sub-pixel

table 7-7 AEC control registers (sheet 4 of 26)

address	register name	default value	R/W	description
0x5621	AEC CTRL21	0x00	RW	Bit[7:3]: Not used Bit[2:0]: roiright_[10:8] Horizontal end point for ROI for long exposure sub-pixel
0x5622	AEC CTRL22	0x00	RW	Bit[7:0]: roiright_[7:0] Horizontal end point for ROI for long exposure sub-pixel
0x5623	AEC CTRL23	0x00	RW	Bit[7:3]: Not used Bit[2:0]: roiright_s[10:8] Horizontal end point for ROI for short exposure sub-pixel
0x5624	AEC CTRL24	0x00	RW	Bit[7:0]: roiright_s[7:0] Horizontal end point for ROI for short exposure sub-pixel
0x5625	AEC CTRL25	0x00	RW	Bit[7:2]: Not used Bit[1:0]: roibottom_[9:8] Vertical end point for ROI for long exposure sub-pixel
0x5626	AEC CTRL26	0x00	RW	Bit[7:0]: roibottom_[7:0] Vertical end point for ROI for long exposure sub-pixel
0x5627	AEC CTRL27	0x00	RW	Bit[7:2]: Not used Bit[1:0]: roibottom_s[9:8] Vertical end point for ROI for short exposure sub-pixel
0x5628	AEC CTRL28	0x00	RW	Bit[7:0]: roibottom_s[7:0] Vertical end point for ROI for short exposure sub-pixel
0x5629	AEC CTRL29	0x00	RW	Bit[7:6]: Not used Bit[5:3]: r_roishifl_ Bit[2:0]: r_roishifl_s
0x562A	AEC CTRL2A	0x01	RW	ROIweightl0 for Long Exposure Sub-pixel
0x562B	AEC CTRL2B	0x01	RW	ROIweightl1 for Long Exposure Sub-pixel
0x562C	AEC CTRL2C	0x01	RW	ROIweights0 for Short Exposure Sub-pixel
0x562D	AEC CTRL2D	0x01	RW	ROIweights1 for Short Exposure Sub-pixel
0x562E	AEC CTRL2E	0x01	RW	Weightl0 for Long Exposure Sub-pixel
0x562F	AEC CTRL2F	0x01	RW	Weightl1 for Long Exposure Sub-pixel
0x5630	AEC CTRL30	0x01	RW	Weightl2 for Long Exposure Sub-pixel

table 7-7 AEC control registers (sheet 5 of 26)

address	register name	default value	R/W	description
0x5631	AEC CTRL31	0x01	RW	Weightl3 for Long Exposure Sub-pixel
0x5632	AEC CTRL32	0x01	RW	Weightl4 for Long Exposure Sub-pixel
0x5633	AEC CTRL33	0x01	RW	Weightl5 for Long Exposure Sub-pixel
0x5634	AEC CTRL34	0x01	RW	Weightl6 for Long Exposure Sub-pixel
0x5635	AEC CTRL35	0x01	RW	Weightl7 for Long Exposure Sub-pixel
0x5636	AEC CTRL36	0x01	RW	Weightl8 for Long Exposure Sub-pixel
0x5637	AEC CTRL37	0x01	RW	Weightl9 for Long Exposure Sub-pixel
0x5638	AEC CTRL38	0x01	RW	Weightla for Long Exposure Sub-pixel
0x5639	AEC CTRL39	0x01	RW	Weightlb for Long Exposure Sub-pixel
0x563A	AEC CTRL3A	0x01	RW	Weightlc for Long Exposure Sub-pixel
0x563B	AEC CTRL3B	0x01	RW	Weights0 for Short Exposure Sub-pixel
0x563C	AEC CTRL3C	0x01	RW	Weights1 for Short Exposure Sub-pixel
0x563D	AEC CTRL3D	0x01	RW	Weights2 for Short Exposure Sub-pixel
0x563E	AEC CTRL3E	0x01	RW	Weights3 for Short Exposure Sub-pixel
0x563F	AEC CTRL3F	0x01	RW	Weights4 for Short Exposure Sub-pixel
0x5640	AEC CTRL40	0x01	RW	Weights5 for Short Exposure Sub-pixel
0x5641	AEC CTRL41	0x01	RW	Weights6 for Short Exposure Sub-pixel
0x5642	AEC CTRL42	0x01	RW	Weights7 for Short Exposure Sub-pixel
0x5643	AEC CTRL43	0x01	RW	Weights8 for Short Exposure Sub-pixel
0x5644	AEC CTRL44	0x01	RW	Weights9 for Short Exposure Sub-pixel
0x5645	AEC CTRL45	0x01	RW	Weightsa for Short Exposure Sub-pixel
0x5646	AEC CTRL46	0x01	RW	Weightsb for Short Exposure Sub-pixel
0x5647	AEC CTRL47	0x01	RW	Weightsc for Short Exposure Sub-pixel
0x5648	AEC CTRL48	0x01	RW	Minwl for Long Exposure Sub-pixel
0x5649	AEC CTRL49	0x01	RW	Minws for Short Exposure Sub-pixel
0x564A	AEC CTRL4A	0x00	RW	Bit[7:2]: Not used Bit[1:0]: Maxwl[9:8] for long exposure sub-pixel
0x564B	AEC CTRL4B	0x20	RW	Bit[7:0]: Maxwl[7:0] for long exposure sub-pixel

table 7-7 AEC control registers (sheet 6 of 26)

address	register name	default value	R/W	description
0x564C	AEC CTRL4C	0x01	RW	Bit[7:2]: Not used Bit[1:0]: Maxws[9:8] for short exposure sub-pixel
0x564D	AEC CTRL4D	0x00	RW	Bit[7:0]: Maxws[7:0] for short exposure sub-pixel
0x564E	AEC CTRL4E	0x00	RW	Poswshift
0x564F	AEC CTRL4F	0x04	RW	Lowlightthre
0x5650	AEC CTRL50	0xF0	RW	Highlightthre
0x5651	AEC CTRL51	0x04	RW	Bit[7]: Not used Bit[6:0]: Finalsaturathre[14:8]
0x5652	AEC CTRL52	0x00	RW	Bit[7:0]: Finalsaturathre[7:0]
0x5653	AEC CTRL53	0x04	RW	Bit[7:0]: r_blackthre1_[15:8] for long exposure sub-pixel
0x5654	AEC CTRL54	0x00	RW	Bit[7:0]: r_blackthre1_[7:0] for long exposure sub-pixel
0x5655	AEC CTRL55	0x10	RW	Bit[7:0]: r_blackthre1_s[15:8] for short exposure sub-pixel
0x5656	AEC CTRL56	0x00	RW	Bit[7:0]: r_blackthre1_s[7:0] for short exposure sub-pixel
0x5657	AEC CTRL57	0x20	RW	Bit[7:0]: r_blackthre2_[15:8] for long exposure sub-pixel
0x5658	AEC CTRL58	0x00	RW	Bit[7:0]: r_blackthre2_[7:0] for long exposure sub-pixel
0x5659	AEC CTRL59	0x40	RW	Bit[7:0]: r_blackthre2_s[15:8] for short exposure sub-pixel
0x565A	AEC CTRL5A	0x00	RW	Bit[7:0]: r_blackthre2_s[7:0] for short exposure sub-pixel
0x565B	AEC CTRL5B	0x10	RW	Bit[7]: Not used Bit[6:0]: r_blackweight1_[6:0] for long exposure sub-pixel
0x565C	AEC CTRL5C	0x08	RW	Bit[7]: Not used Bit[6:0]: r_blackweight1_s[6:0] for short exposure sub-pixel
0x565D	AEC CTRL5D	0x14	RW	Bit[7]: Not used Bit[6:0]: r_blackweight2_[6:0] for long exposure sub-pixel

table 7-7 AEC control registers (sheet 7 of 26)

address	register name	default value	R/W	description
0x565E	AEC CTRL5E	0x12	RW	Bit[7]: Not used Bit[6:0]: r_blackweight2_s[6:0] for short exposure sub-pixel
0x565F	AEC CTRL5F	0x08	RW	Bit[7:0]: r_saturathre1_l[15:8] for long exposure sub-pixel
0x5660	AEC CTRL60	0x00	RW	Bit[7:0]: r_saturathre1_l[7:0] for long exposure sub-pixel
0x5661	AEC CTRL61	0x04	RW	Bit[7:0]: r_saturathre1_s[15:8] for short exposure sub-pixel
0x5662	AEC CTRL62	0x00	RW	Bit[7:0]: r_saturathre1_s[7:0] for short exposure sub-pixel
0x5663	AEC CTRL63	0x10	RW	Bit[7:0]: r_saturathre2_l[15:8] for long exposure sub-pixel
0x5664	AEC CTRL64	0x00	RW	Bit[7:0]: r_saturathre2_l[7:0] for long exposure sub-pixel
0x5665	AEC CTRL65	0x20	RW	Bit[7:0]: r_saturathre2_s[15:8] for short exposure sub-pixel
0x5666	AEC CTRL66	0x00	RW	Bit[7:0]: r_saturathre2_s[7:0] for short exposure sub-pixel
0x5667	AEC CTRL67	0x10	RW	Bit[7]: Not used Bit[6:0]: r_saturateweight1_l[6:0] for long exposure sub-pixel
0x5668	AEC CTRL68	0x12	RW	Bit[7]: Not used Bit[6:0]: r_saturateweight1_s[6:0] for short exposure sub-pixel
0x5669	AEC CTRL69	0x12	RW	Bit[7]: Not used Bit[6:0]: r_saturateweight2_l[6:0] for long exposure sub-pixel
0x566A	AEC CTRL6A	0x14	RW	Bit[7]: Not used Bit[6:0]: r_saturateweight2_s[6:0] for short exposure sub-pixel
0x566B	AEC CTRL6B	0x00	RW	Bit[7]: fix_whole Bit[6]: fix_eof Bit[5:4]: fix_select 01: my_l 10: my_s 11: idat Bit[3:0]: fix_value
0x566C	AEC CTRL6C	0x00	RW	Bit[7:1]: Not used Bit[0]: r_his_en

table 7-7 AEC control registers (sheet 8 of 26)

address	register name	default value	R/W	description
0x566D	AEC CTRL6D	0x00	RW	Bit[7:0]: r_his_addr
0x566E	AEC CTRL6E	–	R	Bit[7]: Not used Bit[6:0]: r_his_data[14:8]
0x566F	AEC CTRL6F	–	R	Bit[7:0]: r_his_data[7:0]
0x5680~ 0x56C7	AEC CTRL80~ AEC CTRLC7	–	–	Chip Debug
0x56D0	AEC CTRLD0	0x00	RW	Bit[7:3]: Not used Bit[2]: snrgain_sync_en Bit[1]: aecagc_debug Bit[0]: aecagc_man_en
0x56D1	AEC CTRLD1	0x00	RW	Bit[7:2]: Not used Bit[1:0]: r_cameragain_l_m[9:8]
0x56D2	AEC CTRLD2	0x10	RW	Bit[7:0]: r_cameragain_l_m[7:0]
0x56D3	AEC CTRLD3	0x00	RW	Bit[7:2]: Not used Bit[1:0]: r_cameragain_s_m[9:8]
0x56D4	AEC CTRLD4	0x10	RW	Bit[7:0]: r_cameragain_s_m[7:0]
0x56D5	AEC CTRLD5	0x00	RW	Bit[7:0]: r_exp_l_m[31:24]
0x56D6	AEC CTRLD6	0x00	RW	Bit[7:0]: r_exp_l_m[23:16]
0x56D7	AEC CTRLD7	0x00	RW	Bit[7:0]: r_exp_l_m[15:8]
0x56D8	AEC CTRLD8	0x00	RW	Bit[7:0]: r_exp_l_m[7:0]
0x56D9	AEC CTRLD9	0x00	RW	Bit[7:0]: r_exp_s_m[31:24]
0x56DA	AEC CTRLDA	0x00	RW	Bit[7:0]: r_exp_s_m[23:16]
0x56DB	AEC CTRLDB	0x00	RW	Bit[7:0]: r_exp_s_m[15:8]
0x56DC	AEC CTRLDC	0x00	RW	Bit[7:0]: r_exp_s_m[7:0]
0x56DF	AEC CTRLDF	0x02	RW	Bit[7:3]: Not used Bit[2:0]: r_digigain_l_m[10:8]
0x56E0	AEC CTRL E0	0x00	RW	Bit[7:0]: r_digigain_l_m[7:0]
0x56E1	AEC CTRL E1	0x02	RW	Bit[7:3]: Not used Bit[2:0]: r_digigain_s_m[10:8]
0x56E2	AEC CTRL E2	0x00	RW	Bit[7:0]: r_digigain_s_m[7:0]
0x56E3	AEC CTRL E3	0x00	RW	Bit[7:1]: Not used Bit[0]: r_exp_ctrl

table 7-7 AEC control registers (sheet 9 of 26)

address	register name	default value	R/W	description
0x56E4	AEC CTRL4	0x00	RW	Bit[7:4]: Not used Bit[3:0]: r_exp_l_f[11:8]
0x56E5	AEC CTRL5	0x00	RW	Bit[7:0]: r_exp_l_f[7:0]
0x56E6	AEC CTRL6	0x00	RW	Bit[7:4]: Not used Bit[3:0]: r_exp_s_f[11:8]
0x56E7	AEC CTRL7	0x00	RW	Bit[7:0]: r_exp_s_f[7:0]
0x56E8	AEC CTRL8	0x00	RW	Bit[7:1]: Not used Bit[0]: r_snr_gain_l_m[8]
0x56E9	AEC CTRL9	0x00	RW	Bit[7:0]: r_snr_gain_l_m[7:0]
0x56EA	AEC CTRL10	0x00	RW	Bit[7:1]: Not used Bit[0]: r_snr_gain_s_m[8]
0x56EB	AEC CTRL11	0x00	RW	Bit[7:0]: r_snr_gain_s_m[7:0]
0xC2ED	NON-HDR MODE AT HIGH TEMPERATURES	0x00	RW	Bit[7:1]: Not used Bit[0]: Non-HDR mode at high temperatures Set to 0 if HDR mode is on. Set to 1 if non-HDR mode is on. This register value will be automatically initialized by sensor after powering up.
0xC2EE~ 0xC2EF	RSVD	-	-	Reserved
0xC2F0	S_MANUAL_EXP11	-	RW	Bit[7:0]: manual_expo11[15:8] This register value will be automatically initialized by sensor after powering up. Default value is random.
0xC2F1	S_MANUAL_EXP11	-	RW	Bit[7:0]: manual_expo11[7:0] This register value will be automatically initialized by sensor after powering up. Default value is random.
0xC2F2	S_MANUAL_EXP12	-	RW	Bit[7:0]: manual_expo12[15:8] This register value will be automatically initialized by sensor after powering up. Default value is random.
0xC2F3	S_MANUAL_EXP12	-	RW	Bit[7:0]: manual_expo12[7:0] This register value will be automatically initialized by sensor after powering up. Default value is random.

table 7-7 AEC control registers (sheet 10 of 26)

address	register name	default value	R/W	description
				Bit[7:0]: manual_expo21[15:8]
0xC2F4	S_MANUAL_EXP21	–	RW	This register value will be automatically initialized by sensor after powering up. Default value is random.
				Bit[7:0]: manual_expo21[7:0]
0xC2F5	S_MANUAL_EXP21	–	RW	This register value will be automatically initialized by sensor after powering up. Default value is random.
				Bit[7:0]: manual_expo22[15:8]
0xC2F6	S_MANUAL_EXP22	–	RW	This register value will be automatically initialized by sensor after powering up. Default value is random.
				Bit[7:0]: manual_expo22[7:0]
0xC2F7	S_MANUAL_EXP22	–	RW	This register value will be automatically initialized by sensor after powering up. Default value is random.
				Bit[7:0]: manual_expo31[15:8]
0xC2F8	S_MANUAL_EXP31	0x34	RW	This register value will be automatically initialized by sensor after powering up. Default value is random.
				Bit[7:0]: manual_expo31[7:0]
0xC2F9	S_MANUAL_EXP31	–	RW	This register value will be automatically initialized by sensor after powering up. Default value is random.
				Bit[7:0]: manual_expo32[15:0]
0xC2FA	S_MANUAL_EXP32	–	RW	This register value will be automatically initialized by sensor after powering up. Default value is random.
				Bit[7:0]: manual_expo32[7:0]
0xC2FB	S_MANUAL_EXP22	–	RW	This register value will be automatically initialized by sensor after powering up. Default value is random.
				Bit[7:0]: manual_gain11[15:8]
0xC2FC	S_MANUAL_GAIN11	–	RW	This register value will be automatically initialized by sensor after powering up. Default value is random.

table 7-7 AEC control registers (sheet 11 of 26)

address	register name	default value	R/W	description
				Bit[7:0]: manual_gain11[7:0]
0xC2FD	S_MANUAL_GAIN11	–	RW	This register value will be automatically initialized by sensor after powering up. Default value is random.
				Bit[7:0]: manual_gain12[15:8]
0xC2FE	S_MANUAL_GAIN12	–	RW	This register value will be automatically initialized by sensor after powering up. Default value is random.
				Bit[7:0]: manual_gain12[7:0]
0xC2FF	S_MANUAL_GAIN12	–	RW	This register value will be automatically initialized by sensor after powering up. Default value is random.
				Bit[7:0]: manual_gain21[15:8]
0xC300	S_MANUAL_GAIN21	–	RW	This register value will be automatically initialized by sensor after powering up. Default value is random.
				Bit[7:0]: manual_gain21[7:0]
0xC301	S_MANUAL_GAIN21	–	RW	This register value will be automatically initialized by sensor after powering up. Default value is random.
				Bit[7:0]: manual_gain22[15:8]
0xC302	S_MANUAL_GAIN22	–	RW	This register value will be automatically initialized by sensor after powering up. Default value is random.
				Bit[7:0]: manual_gain22[7:0]
0xC303	S_MANUAL_GAIN22	–	RW	This register value will be automatically initialized by sensor after powering up. Default value is random.
				Bit[7:0]: manual_gain31[15:8]
0xC304	S_MANUAL_GAIN31	–	RW	This register value will be automatically initialized by sensor after powering up. Default value is random.
				Bit[7:0]: manual_gain31[7:0]
0xC305	S_MANUAL_GAIN31	–	RW	This register value will be automatically initialized by sensor after powering up. Default value is random.

table 7-7 AEC control registers (sheet 12 of 26)

address	register name	default value	R/W	description
0xC306	S_MANUAL_GAIN32	–	RW	Bit[7:0]: manual_gain32[15:8] This register value will be automatically initialized by sensor after powering up. Default value is random.
0xC307	S_MANUAL_GAIN32	–	RW	Bit[7:0]: manual_gain32[7:0] This register value will be automatically initialized by sensor after powering up. Default value is random.
0xC308	S_MANUAL_EN	–	RW	Bit[7:1]: Not used Bit[0]: manual_en 0: Disable 1: Enable When register value is 0x00, it means function is disabled; all other values mean function is enabled. This register value must be initialized by user and must not be removed from start up sequence. Default value is random.
0xC309	S_MANUAL_MODE	–	RW	Bit[7:3]: Not used Bit[2]: targetc_manual_en 0: Disable 1: Enable Bit[1]: targetb_manual_en 0: Disable 1: Enable Bit[0]: targeta_manual_en 0: Disable 1: Enable This register value must be initialized by user and must not be removed from start up sequence. Default value is random.
0xC30A	S_MANUAL_DONE	–	RW	Bit[7:2]: Not used Bit[1:0]: manual_done 00: Write protected 01: Write valid once 10: Write valid always This register value must be initialized by user and must not be removed from start up sequence. Default value is random.

table 7-7 AEC control registers (sheet 13 of 26)

address	register name	default value	R/W	description
0xC450	TARGET_NUM	–	RW	Bit[7:2]: Not used Bit[1:0]: Target number 01: AA mode 10: AB mode 11: ABC mode This register value must be initialized by user and must not be removed from start up sequence. Default value is random.
0xC451	HW_STOP_EN	0x00	RW	Chip Debug
0xC452	LS_SENS_RATIO_1	–	RW	Bit[7:0]: L/S sensitivity ratio[15:8] This register value must be initialized by user and must not be removed from start up sequence. Default value is random.
0xC453	LS_SENS_RATIO_2	–	RW	Bit[7:0]: L/S sensitivity ratio[7:0] This register value must be initialized by user and must not be removed from start up sequence. Default value is random.
0xC454	NONHDR_EN	–	RW	Bit[7:1]: Not used Bit[0]: Non-HDR mode 0: Disable 1: Enable When register value is 0x00, it means function is disabled; all other values mean function is enabled. This register value must be initialized by user and must not be removed from start up sequence. Default value is random.
0xC455	SINGLE_EXP_MODE_EN	–	RW	Bit[7:1]: Not used Bit[0]: Single exposure mode enable 0: Disable 1: Enable When register value is 0x00, it means function is disabled; all other values mean function is enabled. This register value must be initialized by user and must not be removed from start up sequence. Default value is random.

table 7-7 AEC control registers (sheet 14 of 26)

address	register name	default value	R/W	description
0xC456	FIXED_RATIO_EN	–	RW	<p>Bit[7:1]: Not used Bit[0]: Fixed ratio mode 0: Disable 1: Enable</p> <p>When register value is 0x00, it means function is disabled; all other values mean function is enabled. This register value must be initialized by user and must not be removed from start up sequence. Default value is random.</p>
0xC457	GP_MODE_EN	–	RW	<p>Bit[7:1]: Not used Bit[0]: Geometric proportion mode 0: Disable 1: Enable</p> <p>When register value is 0x00, it means function is disabled; all other values mean function is enabled. This register value must be initialized by user and must not be removed from start up sequence. Default value is random.</p>
0xC458	NIGHT_MODE_EN	–	RW	<p>Bit[7:1]: Not used Bit[0]: Night mode 0: Disable 1: Enable</p> <p>When register value is 0x00, it means function is disabled; all other values mean function is enabled. This register value must be initialized by user and must not be removed from start up sequence. Default value is random.</p>
0xC459	NIGHT_MODE_CTRL	–	RW	<p>Bit[7:1]: Not used Bit[0]: Only insert frame when in night mode 0: Disable 1: Enable</p> <p>When register value is 0x00, it means function is disabled; all other values mean function is enabled. This register value must be initialized by user and must not be removed from start up sequence. Default value is random.</p>

table 7-7 AEC control registers (sheet 15 of 26)

address	register name	default value	R/W	description
0xC45A	FRACTAL_EXP_EN	–	RW	<p>Bit[7:1]: Not used Bit[0]: Allow fractal exposure 0: Disable 1: Enable</p> <p>When register value is 0x00, it means function is disabled; all other values mean function is enabled. This register value will be automatically initialized by sensor after powering up. Default value is random.</p>
0xC45B	CHIP_DEBUG	–	–	<p>Chip Debug</p> <p>This register value must be initialized by user and must not be removed from start up sequence. Default value is random.</p>
0xC45C	MANU_GAMMA_EN	–	RW	<p>Bit[7:1]: Not used Bit[0]: Manual gamma mode 0: Disable 1: Enable</p> <p>When register value is 0x00, it means function is disabled; all other values mean function is enabled. This register value must be initialized by user and must not be removed from start up sequence. Default value is random.</p>
0xC45D	CHIP_DEBUG	–	–	<p>Chip Debug</p>
0xC45E	BAND_FILTER_FLAG	–	RW	<p>Bit[7:2]: Not used Bit[1:0]: Light source type 00: Frequency is zero or very high 01: 60Hz 10: 50Hz 11: Not valid</p> <p>This register value must be initialized by user and must not be removed from start up sequence. Default value is random.</p>
0xC45F	BAND_FILTER_EN	–	RW	<p>Bit[7:1]: Not used Bit[0]: Banding filter 0: Disable 1: Enable</p> <p>When register value is 0x00, it means function is disabled; all other values mean function is enabled. This register value must be initialized by user and must not be removed from start up sequence. Default value is random.</p>

table 7-7 AEC control registers (sheet 16 of 26)

address	register name	default value	R/W	description
0xC460	BAND_FILTER_SHORT	–	RW	Bit[7:1]: Not used Bit[0]: Short banding filter 0: Disable 1: Enable When register value is 0x00, it means function is disabled; all other values mean function is enabled. This register value must be initialized by user and must not be removed from start up sequence. Default value is random.
0xC461	LESS_1BAND_EN	–	RW	Bit[7:1]: Not used Bit[0]: Less than one band exposure mode 0: Disable 1: Enable When register value is 0x00, it means function is disabled; all other values mean function is enabled. This register value must be initialized by user and must not be removed from start up sequence. Default value is random.
0xC462	LESS_1BAND_SHORT	–	RW	Bit[7:1]: Not used Bit[0]: Less than one band exposure for short 0: Disable 1: Enable When register value is 0x00, it means function is disabled; all other values mean function is enabled. This register value must be initialized by user and must not be removed from start up sequence. Default value is random.
0xC463	CHIP_DEBUG	–	–	Chip Debug
0xC464	LOG_TARGET_11	–	RW	Bit[7:0]: Log target 1[15:8] This register value must be initialized by user and must not be removed from start up sequence. Default value is random.
0xC465	LOG_TARGET_12	–	RW	Bit[7:0]: Log target 1[7:0] This register value must be initialized by user and must not be removed from start up sequence. Default value is random.
0xC466	LOG_TARGET_21	–	RW	Bit[7:0]: Log target 2[15:8] This register value must be initialized by user and must not be removed from start up sequence. Default value is random.

table 7-7 AEC control registers (sheet 17 of 26)

address	register name	default value	R/W	description
				Bit[7:0]: Log target 2[7:0]
0xC467	LOG_TARGET_22	–	RW	This register value must be initialized by user and must not be removed from start up sequence. Default value is random.
				Bit[7:0]: Log target 3[15:8]
0xC468	LOG_TARGET_31	–	RW	This register value must be initialized by user and must not be removed from start up sequence. Default value is random.
				Bit[7:0]: Log target 3[7:0]
0xC469	LOG_TARGET_32	–	RW	This register value must be initialized by user and must not be removed from start up sequence. Default value is random.
				Target of Raw Data for Long 1
0xC46A	TARGET_LONG_1	–	RW	This register value must be initialized by user and must not be removed from start up sequence. Default value is random.
				Target of Raw Data for Long 2
0xC46B	TARGET_LONG_2	–	RW	This register value must be initialized by user and must not be removed from start up sequence. Default value is random.
				Target of Raw Data for Long 3
0xC46C	TARGET_LONG_3	–	RW	This register value must be initialized by user and must not be removed from start up sequence. Default value is random.
				Target of Raw Data for Short 1
0xC46D	TARGET_SHORT_1	–	RW	This register value must be initialized by user and must not be removed from start up sequence. Default value is random.
				Target of Raw Data for Short 2
0xC46E	TARGET_SHORT_2	–	RW	This register value must be initialized by user and must not be removed from start up sequence. Default value is random.
				Target of Raw Data for Short 3
0xC46F	TARGET_SHORT_3	–	RW	This register value must be initialized by user and must not be removed from start up sequence. Default value is random.

table 7-7 AEC control registers (sheet 18 of 26)

address	register name	default value	R/W	description
				Slow Range for Long Exposure
0xC470	SLOW_RANGE_LONG	–	RW	This register value will be automatically initialized by sensor after powering up. Default value is random.
				Slow Range for Short Exposure
0xC471	SLOW_RANGE_SHORT	–	RW	This register value will be automatically initialized by sensor after powering up. Default value is random.
				Range Become Stable from Unstable
0xC472	STABLE_RANGE_IN	–	RW	This register value will be automatically initialized by sensor after powering up. Default value is random.
				Range Become Unstable from Stable
0xC473	STABLE_RANGE_OUT	–	RW	This register value will be automatically initialized by sensor after powering up. Default value is random.
				Fast AEC Adjustment Step for Long Exposure
0xC474	FAST_STEP_LONG	–	RW	This register value will be automatically initialized by sensor after powering up. Default value is random.
				Fast AEC Adjustment Step for Short Exposure
0xC475	FAST_STEP_SHORT	–	RW	This register value will be automatically initialized by sensor after powering up. Default value is random.
				Slow AEC Adjustment Step for Long Exposure
0xC476	SLOW_STEP_LONG	–	RW	This register value will be automatically initialized by sensor after powering up. Default value is random.
				Slow AEC Adjustment Step for Short Exposure
0xC477	SLOW_STEP_SHORT	–	RW	This register value will be automatically initialized by sensor after powering up. Default value is random.
				Max Fast Adjustment Ratio
0xC478	MAX_FAST_RATIO	–	RW	This register value will be automatically initialized by sensor after powering up. Default value is random.

table 7-7 AEC control registers (sheet 19 of 26)

address	register name	default value	R/W	description
				Max Slow Adjustment Ratio
0xC479	MAX_SLOW_RATIO	–	RW	This register value will be automatically initialized by sensor after powering up. Default value is random.
0xC47A~ 0xC47B	CHIP_DEBUG	–	–	Chip Debug
				Bit[7:0]: Max short light exposure[31:24]
0xC47C	MAX_SHORT_LE_1	–	RW	This register value must be initialized by user and must not be removed from start up sequence. Default value is random.
				Bit[7:0]: Max short light exposure[23:16]
0xC47D	MAX_SHORT_LE_2	–	RW	This register value must be initialized by user and must not be removed from start up sequence. Default value is random.
				Bit[7:0]: Max short light exposure[15:8]
0xC47E	MAX_SHORT_LE_3	–	RW	This register value must be initialized by user and must not be removed from start up sequence. Default value is random.
				Bit[7:0]: Max short light exposure[7:0]
0xC47F	MAX_SHORT_LE_4	–	RW	This register value must be initialized by user and must not be removed from start up sequence. Default value is random.
				Bit[7:2]: Not used Bit[1:0]: Max gain for long[9:8]
0xC480	MAX_GAIN_LONG_1	–	RW	This register value must be initialized by user and must not be removed from start up sequence. Default value is random.
				Bit[7:0]: Max gain for long[7:0]
0xC481	MAX_GAIN_LONG_2	–	RW	This register value must be initialized by user and must not be removed from start up sequence. Default value is random.
				Bit[7:2]: Not used Bit[1:0]: Max gain for short[9:8]
0xC482	MAX_GAIN_SHORT_1	–	RW	This register value must be initialized by user and must not be removed from start up sequence. Default value is random.

table 7-7 AEC control registers (sheet 20 of 26)

address	register name	default value	R/W	description
0xC483	MAX_GAIN_SHORT_1	–	RW	Bit[7:0]: Max gain for short[7:0] This register value must be initialized by user and must not be removed from start up sequence. Default value is random.
0xC484	MIN_GAIN_LONG_1	–	RW	Bit[7:2]: Not used Bit[1:0]: Min gain for long[9:8] This register value must be initialized by user and must not be removed from start up sequence. Default value is random.
0xC485	MIN_GAIN_LONG_2	–	RW	Bit[7:0]: Min gain for long[7:0] This register value must be initialized by user and must not be removed from start up sequence. Default value is random.
0xC486	MIN_GAIN_SHORT_1	–	RW	Bit[7:2]: Not used Bit[1:0]: Min gain for short[9:8] This register value must be initialized by user and must not be removed from start up sequence. Default value is random.
0xC487	MIN_GAIN_SHORT_2	–	RW	Bit[7:0]: Min gain for short[7:0] This register value must be initialized by user and must not be removed from start up sequence. Default value is random.
0xC488	MAX_EXP_LONG_1	–	RW	Bit[7:0]: Max exposure for long[15:8] This register value must be initialized by user and must not be removed from start up sequence. Default value is random.
0xC489	MAX_EXP_LONG_2	–	RW	Bit[7:0]: Max exposure for long[7:0] This register value must be initialized by user and must not be removed from start up sequence. Default value is random.
0xC48A	MAX_EXP_SHORT_1	–	RW	Bit[7:0]: Max exposure for short[15:8] This register value must be initialized by user and must not be removed from start up sequence. Default value is random.

table 7-7 AEC control registers (sheet 21 of 26)

address	register name	default value	R/W	description
				Bit[7:0]: Max exposure for short[7:0]
0xC48B	MAX_EXP_SHORT_2	–	RW	This register value must be initialized by user and must not be removed from start up sequence. Default value is random.
				Bit[7:0]: Min exposure for long[15:8]
0xC48C	MIN_EXP_LONG_1	–	RW	This register value must be initialized by user and must not be removed from start up sequence. Default value is random.
				Bit[7:0]: Min exposure for long[7:0]
0xC48D	MIN_EXP_LONG_2	–	RW	This register value must be initialized by user and must not be removed from start up sequence. Default value is random.
				Bit[7:0]: Min exposure for short[15:8]
0xC48E	MIN_EXP_SHORT_1	–	RW	This register value must be initialized by user and must not be removed from start up sequence. Default value is random.
				Bit[7:0]: Min exposure for short[7:0]
0xC48F	MIN_EXP_SHORT_2	–	RW	This register value must be initialized by user and must not be removed from start up sequence. Default value is random.
				Fixed Ratio, Value+1
0xC490	FIXED_RATIO	–	RW	This register value must be initialized by user and must not be removed from start up sequence. Default value is random.
0xC491	CHIP_DEBUG	–	–	Chip Debug
				B/A Ratio in Gp Mode
0xC492	GP_MODE_RATIO_B2A	–	RW	This register value must be initialized by user and must not be removed from start up sequence. Default value is random.
				C/A Ratio in Gp Mode
0xC493	GP_MODE_RATIO_C2A	–	RW	This register value must be initialized by user and must not be removed from start up sequence. Default value is random.
0xC494~ 0xC497	CHIP_DEBUG	–	–	Chip Debug

table 7-7 AEC control registers (sheet 22 of 26)

address	register name	default value	R/W	description
				Bit[7:0]: Min gamma list 1[15:8]
0xC498	MIN_GAMMA_LIST_11	–	RW	This register value must be initialized by user and must not be removed from start up sequence. Default value is random.
				Bit[7:0]: Min gamma list 1[7:0]
0xC499	MIN_GAMMA_LIST_12	–	RW	This register value must be initialized by user and must not be removed from start up sequence. Default value is random.
				Bit[7:0]: Min gamma list 2[15:8]
0xC49A	MIN_GAMMA_LIST_21	–	RW	This register value must be initialized by user and must not be removed from start up sequence. Default value is random.
				Bit[7:0]: Min gamma list 2[7:0]
0xC49B	MIN_GAMMA_LIST_22	–	RW	This register value must be initialized by user and must not be removed from start up sequence. Default value is random.
				Bit[7:0]: Min gamma list 3[15:8]
0xC49C	MIN_GAMMA_LIST_31	–	RW	This register value must be initialized by user and must not be removed from start up sequence. Default value is random.
				Bit[7:0]: Min gamma list 3[7:0]
0xC49D	MIN_GAMMA_LIST_32	–	RW	This register value must be initialized by user and must not be removed from start up sequence. Default value is random.
				Bit[7:0]: Max gamma list 1[15:8]
0xC49E	MAX_GAMMA_LIST_11	–	RW	This register value must be initialized by user and must not be removed from start up sequence. Default value is random.
				Bit[7:0]: Max gamma list 1[7:0]
0xC49F	MAX_GAMMA_LIST_12	–	RW	This register value must be initialized by user and must not be removed from start up sequence. Default value is random.
				Bit[7:0]: Max gamma list 2[15:8]
0xC4A0	MAX_GAMMA_LIST_21	–	RW	This register value must be initialized by user and must not be removed from start up sequence. Default value is random.

table 7-7 AEC control registers (sheet 23 of 26)

address	register name	default value	R/W	description
				Bit[7:0]: Max gamma list 2[7:0]
0xC4A1	MAX_GAMMA_LIST_22	–	RW	This register value must be initialized by user and must not be removed from start up sequence. Default value is random.
				Bit[7:0]: Max gamma list 3[15:8]
0xC4A2	MAX_GAMMA_LIST_31	–	RW	This register value must be initialized by user and must not be removed from start up sequence. Default value is random.
				Bit[7:0]: Max gamma list 3[7:0]
0xC4A3	MAX_GAMMA_LIST_32	–	RW	This register value must be initialized by user and must not be removed from start up sequence. Default value is random.
				Bit[7:0]: Dynamic range list 1[15:8]
0xC4A4	DR_LIST_11	–	RW	This register value must be initialized by user and must not be removed from start up sequence. Default value is random.
				Bit[7:0]: Dynamic range list 1[7:0]
0xC4A5	DR_LIST_12	–	RW	This register value must be initialized by user and must not be removed from start up sequence. Default value is random.
				Bit[7:0]: Dynamic range list 2[15:8]
0xC4A6	DR_LIST_21	–	RW	This register value must be initialized by user and must not be removed from start up sequence. Default value is random.
				Bit[7:0]: Dynamic range list 2[7:0]
0xC4A7	DR_LIST_22	–	RW	This register value must be initialized by user and must not be removed from start up sequence. Default value is random.
				Bit[7:0]: Dynamic range list 3[15:8]
0xC4A8	DR_LIST_31	–	RW	This register value must be initialized by user and must not be removed from start up sequence. Default value is random.
				Bit[7:0]: Dynamic range list 3[7:0]
0xC4A9	DR_LIST_32	–	RW	This register value must be initialized by user and must not be removed from start up sequence. Default value is random.

table 7-7 AEC control registers (sheet 24 of 26)

address	register name	default value	R/W	description
0xC4AA	BAND_VALUE_60HZ_1	–	RW	Bit[7:0]: Band filter value for 60Hz[15:8] This register value must be initialized by user and must not be removed from start up sequence. Default value is random.
0xC4AB	BAND_VALUE_60HZ_2	–	RW	Bit[7:0]: Band filter value for 60Hz[7:0] This register value must be initialized by user and must not be removed from start up sequence. Default value is random.
0xC4AC	BAND_VALUE_50HZ_1	–	RW	Bit[7:0]: Band filter value for 50Hz[15:8] This register value must be initialized by user and must not be removed from start up sequence. Default value is random.
0xC4AD	BAND_VALUE_50HZ_2	–	RW	Bit[7:0]: Band filter value for 50Hz[7:0] This register value must be initialized by user and must not be removed from start up sequence. Default value is random.
0xC4AE~ 0xC4B0	CHIP DEBUG	–	–	Chip Debug
0xC4B1	MIN_DR_RATIO	0x02	RW	Min Dynamic Ratio This register value will be automatically initialized by sensor after powering up. Default value is random.
0xC4B2	MAX_DR_RATIO_1	–	RW	Bit[7:0]: Max dynamic ratio[15:8] This register value will be automatically initialized by sensor after powering up. Default value is random.
0xC4B3	MAX_DR_RATIO_2	–	RW	Bit[7:0]: Max dynamic ratio[7:0] This register value will be automatically initialized by sensor after powering up. Default value is random.
0xC514	SENSOR_CLK_RATIO_1	–	RW	Bit[7:0]: Sensor clock ratio[15:8] This register value must be initialized by user and must not be removed from start up sequence. Default value is random.

table 7-7 AEC control registers (sheet 25 of 26)

address	register name	default value	R/W	description
				Bit[7:0]: Sensor clock ratio[7:0]
0xC515	SENSOR_CLK_RATIO_2	–	RW	This register value must be initialized by user and must not be removed from start up sequence. Default value is random.
0xC516	CHIP_DEBUG	–	–	Chip Debug
				Bit[7:0]: VTS[15:8]
0xC518	VTS_ADDR_1	–	RW	This register value must be initialized by user and must not be removed from start up sequence. Default value is random.
				Bit[7:0]: VTS[7:0]
0xC519	VTS_ADDR_2	–	RW	This register value must be initialized by user and must not be removed from start up sequence. Default value is random.
0xC51A~ 0xC51B	CHIP_DEBUG	–	–	Chip Debug
0x5A00~ 0x5A03	AEC_R	–	R	Debug Information for AEC Control
0x5C00	AEC_RW00	–	R	Bit[7:0]: Exposure long[31:24]
0x5C01	AEC_RW01	–	R	Bit[7:0]: Exposure long[23:16]
0x5C02	AEC_RW02	–	R	Bit[7:0]: Exposure long[15:8]
0x5C03	AEC_RW03	–	R	Bit[7:0]: Exposure long[7:0]
0x5C04	AEC_RW04	–	R	Bit[7:0]: Exposure short[31:24]
0x5C05	AEC_RW05	–	R	Bit[7:0]: Exposure short[23:16]
0x5C06	AEC_RW06	–	R	Bit[7:0]: Exposure short[15:8]
0x5C07	AEC_RW07	–	R	Bit[7:0]: Exposure short[7:0]
0x5C08	AEC_RW08	–	R	Bit[7:0]: add_vts[15:8]
0x5C09	AEC_RW09	–	R	Bit[7:0]: add_vts[7:0]
0x5C0A	AEC_RW0A	–	R	Bit[7:3]: Not used Bit[2]: Evenframeflag Bit[1:0]: targettag[1:0]
0x5C0C	AEC_RW0C	–	R	Bit[7:1]: Not used Bit[0]: Snrgain long[8]
0x5C0D	AEC_RW0D	–	R	Bit[7:0]: Snrgain long[7:0]

table 7-7 AEC control registers (sheet 26 of 26)

address	register name	default value	R/W	description
0x5C0E	AEC_RW0E	–	R	Bit[7:1]: Not used Bit[0]: Snrgain short[8]
0x5C0F	AEC_RW0F	–	R	Bit[7:0]: Snrgain short[7:0]
0x5C10	AEC_RW10	–	R	Bit[7:2]: Not used Bit[1:0]: PcameraGain long[9:8]
0x5C11	AEC_RW11	–	R	Bit[7:0]: PcameraGain long[7:0]
0x5C12	AEC_RW12	–	R	Bit[7:2]: Not used Bit[1:0]: PcameraGain short[9:8]
0x5C13	AEC_RW13	–	R	Bit[7:0]: PcameraGain short[7:0]
0x5C14	AEC_RW14	–	R	Bit[7:2]: Not used Bit[1:0]: PdigiGain long[9:8]
0x5C15	AEC_RW15	–	R	Bit[7:0]: PdigiGain long[7:0]
0x5C16	AEC_RW16	–	R	Bit[7:2]: Not used Bit[1:0]: PdigiGain short[9:8]
0x5C17	AEC_RW17	–	R	Bit[7:0]: PdigiGain short[7:0]

7.8 ISP control [0x5000 - 0x500E, 0x503B - 0x503E, 0x5040 - 0x5044]

table 7-8 ISP control registers (sheet 1 of 4)

address	register name	default value	R/W	description
0x5000	ISP RW00	0xFF	RW	Bit[7]: Color matrix enable Bit[6]: Color interpolation enable Bit[5]: Denoise enable Bit[4]: White defect pixel correction enable Bit[3]: Black defect pixel correction enable Bit[2]: AWB statistic enable Bit[1]: AWB gain enable Bit[0]: Lens shading correction enable

table 7-8 ISP control registers (sheet 2 of 4)

address	register name	default value	R/W	description
0x5001	ISP RW01	0xBF	RW	Bit[7]: Data and its weight synchronization enable Bit[6]: Black/white mode enable Bit[5]: Dark level filter enable Bit[4]: Buffer control enable Bit[3]: AEC enable Bit[2]: Tone mapping enable Bit[1]: Normalize enable Bit[0]: Long-short combination enable
0x5002	ISP RW02	0x7E	RW	Bit[7]: OTP manual offset enable Bit[6]: OTP function enable Bit[5]: ALU function enable Bit[4]: CT AWB function enable Bit[3]: Digital gain enable Bit[2]: Window border cut enable Bit[1]: Dithering enable Bit[0]: Chip debug
0x5003	ISP RW03	0x04	RW	Bit[7:5]: Not used Bit[4]: YUV444to422_drop Bit[3]: Latch_sel 0: Pre_sof 1: VSYNC Bit[2:0]: EOF_sel 000: AEC_done 001: Simple_awb_done 010: Tone_mapping_done 011: Combine_done 100: AEC_done and simple_AWB_done and tone_mapping_done and combine_done
0x5004	ISP RW04	0x14	RW	Bit[7:5]: Not used Bit[4]: Auto window enable 0: Manually set image window for DSP blocks 1: Automatically handle image window Bit[3]: Not used Bit[2:0]: Dummy line number for ISP

table 7-8 ISP control registers (sheet 3 of 4)

address	register name	default value	R/W	description
0x5005	ISP RW05	0x08	RW	Bit[7]: Vertical subsampling enable 0: Disable 1: Enable Bit[6]: Lens shading correction center option 0: Manually set by register 1: Automatically set based on image window Bit[5]: Output row in drop mode of subsampling 0: First row 1: Second row Bit[4]: Output column in drop mode of subsampling 0: First pair 1: Second pair Bit[3]: Average enable in non-drop mode of subsampling 0: Sum 1: Average Bit[2]: Green/Y channel subsampling mode 0: Non-drop 1: Drop Bit[1]: RB/UV channel subsampling mode 0: Non-drop 1: Drop Bit[0]: Subsampling mode enable 0: Full resolution 1: Subsampling
0x5006	ISP RW06	0x00	RW	Bit[7:6]: raw_mode_man Bit[5:4]: yuv_mode_man Bit[3]: raw_mode_man_en Bit[2]: yuv_mode_man_en Bit[1]: yuv_en_man Bit[0]: yuv_en_man enable
0x5007	ISP RW07	0x00	RW	Bit[7:3]: Not used Bit[2:0]: isp_x_offset[10:8]
0x5008	ISP RW08	0x00	RW	Bit[7:0]: isp_x_offset[7:0]
0x5009	ISP RW09	0x00	RW	Bit[7:2]: Not used Bit[1:0]: isp_y_offset[9:8]
0x500A	ISP RW10	0x00	RW	Bit[7:0]: isp_y_offset[7:0]
0x500B	ISP RW11	0x00	RW	Bit[7:3]: Not used Bit[2:0]: otp_x_offset[10:8]
0x500C	ISP RW12	0x00	RW	Bit[7:0]: otp_x_offset[7:0]

table 7-8 ISP control registers (sheet 4 of 4)

address	register name	default value	R/W	description
0x500D	ISP RW13	0x00	RW	Bit[7:2]: Not used Bit[1:0]: otp_y_offset[9:8]
0x500E	ISP RW14	0x00	RW	Bit[7:0]: otp_y_offset[7:0]
0x503B	ISP RW59	0x00	RW	Bit[7:2]: Not used Bit[1:0]: line_int_vsize[9:8]
0x503C	ISP RW60	0x02	RW	Bit[7:0]: line_int_vsize[7:0]
0x503D	ISP RW61	0x00	RW	Bit[7]: pre_isp_test_en_i Bit[6]: Not used Bit[5:4]: pre_isp_bar_style_i Bit[3]: Not used Bit[2]: pre_isp_rolling_i Bit[1]: pre_isp_isp_test_i Bit[0]: pre_isp_rnd_same_i
0x503E	ISP RW62	0x00	RW	Bit[7:4]: pre_isp_seed_i Bit[3]: pre_isp_squ_bw_i Bit[2]: pre_isp_trans_i Bit[1:0]: pre_isp_test_sel_i
0x5040~ 0x5043	ISP RO	–	R	Debug Information for ISP Control
0x5044	ISP RW68	0x00	RW	Bit[7:0]: isp_risc_debug[7:0]

7.9 LENC control [0x5080 - 0x5098, 0x509C - 0x50B8]

table 7-9 LENC control registers (sheet 1 of 4)

address	register name	default value	R/W	description
0x5080	LENC CTRL0	0x10	RW	Bit[7]: Not used Bit[6]: Gain manual mode enable 0: Use auto gain 1: Use manual gain set by user Bit[5]: Auto LENC switch enable 0: LENC gain is fixed 1: LENC gain adjusts according to sensor gain Bit[4:0]: Manual gain input
0x5081	LENC CTRL1	0x00	RW	Bit[7:3]: Not used Bit[2:0]: long_red_x0[10:8]
0x5082	LENC CTRL2	0x00	RW	Bit[7:0]: long_red_x0[7:0]

table 7-9 LENC control registers (sheet 2 of 4)

address	register name	default value	R/W	description
0x5083	LENC CTRL3	0x00	RW	Bit[7:2]: Not used Bit[1:0]: long_red_y0[9:8]
0x5084	LENC CTRL4	0x00	RW	Bit[7:0]: long_red_y0[7:0]
0x5085	LENC CTRL5	0x00	RW	Bit[7]: Not used Bit[6:0]: long_red_a1
0x5086	LENC CTRL6	0x01	RW	Bit[7:4]: Not used Bit[3:0]: long_red_a2
0x5087	LENC CTRL7	0x00	RW	Bit[7]: long_red_sign Bit[6:0]: long_red_b1
0x5088	LENC CTRL8	0x01	RW	Bit[7:4]: Not used Bit[3:0]: long_red_b2
0x5089	LENC CTRL9	0x00	RW	Bit[7:3]: Not used Bit[2:0]: long_grn_x0[10:8]
0x508A	LENC CTRL10	0x00	RW	Bit[7:0]: long_grn_x0[7:0]
0x508B	LENC CTRL11	0x00	RW	Bit[7:2]: Not used Bit[1:0]: long_grn_y0[9:8]
0x508C	LENC CTRL12	0x00	RW	Bit[7:0]: long_grn_y0[7:0]
0x508D	LENC CTRL13	0x00	RW	Bit[7]: Not used Bit[6:0]: long_grn_a1
0x508E	LENC CTRL14	0x01	RW	Bit[7:4]: Not used Bit[3:0]: long_grn_a2
0x508F	LENC CTRL15	0x00	RW	Bit[7]: long_grn_sign Bit[6:0]: long_grn_b1
0x5090	LENC CTRL16	0x01	RW	Bit[7:4]: Not used Bit[3:0]: long_grn_b2
0x5091	LENC CTRL17	0x00	RW	Bit[7:3]: Not used Bit[2:0]: long_blu_x0[10:8]
0x5092	LENC CTRL18	0x00	RW	Bit[7:0]: long_blu_x0[7:0]
0x5093	LENC CTRL19	0x00	RW	Bit[7:2]: Not used Bit[1:0]: long_blu_y0[9:8]
0x5094	LENC CTRL20	0x00	RW	Bit[7:0]: long_blu_y0[7:0]
0x5095	LENC CTRL21	0x00	RW	Bit[7]: Not used Bit[6:0]: long_blu_a1
0x5096	LENC CTRL22	0x01	RW	Bit[7:4]: Not used Bit[3:0]: long_blu_a2

table 7-9 LENC control registers (sheet 3 of 4)

address	register name	default value	R/W	description
0x5097	LENC CTRL23	0x0	RW	Bit[7]: long_blu_sign Bit[6:0]: long_blu_b1
0x5098	LENC CTRL24	0x01	RW	Bit[7:4]: Not used Bit[3:0]: long_blu_b2
0x509C	LENC CTRL28	0x00	RW	Bit[7:5]: Not used Bit[4:0]: Min LENC gain
0x509D	LENC CTRL29	0x00	RW	Bit[7:2]: Not used Bit[1:0]: Sensor gain1[9:8] (must be less than 0x200)
0x509E	LENC CTRL30	0x00	RW	Bit[7:0]: Sensor gain1[7:0]
0x509F	LENC CTRL31	0x00	RW	Bit[7:2]: Not used Bit[1:0]: Sensor gain2[9:8] (must be less than 0x200)
0x50A0	LENC CTRL32	0x00	RW	Bit[7:0]: Sensor gain2[7:0]
0x50A1	LENC CTRL33	0x00	RW	Bit[7:3]: Not used Bit[2:0]: short_red_x0[10:8]
0x50A2	LENC CTRL34	0x00	RW	Bit[7:0]: short_red_x0[7:0]
0x50A3	LENC CTRL35	0x00	RW	Bit[7:2]: Not used Bit[1:0]: short_red_y0[9:8]
0x50A4	LENC CTRL36	0x00	RW	Bit[7:0]: short_red_y0[7:0]
0x50A5	LENC CTRL37	0x00	RW	Bit[7]: Not used Bit[6:0]: short_red_a1
0x50A6	LENC CTRL38	0x01	RW	Bit[7:4]: Not used Bit[3:0]: short_red_a2
0x50A7	LENC CTRL39	0x00	RW	Bit[7]: short_red_sign Bit[6:0]: short_red_b1
0x50A8	LENC CTRL40	0x01	RW	Bit[7:4]: Not used Bit[3:0]: short_red_b2
0x50A9	LENC CTRL41	0x00	RW	Bit[7:3]: Not used Bit[2:0]: short_grn_x0[10:8]
0x50AA	LENC CTRL42	0x00	RW	Bit[7:0]: short_grn_x0[7:0]
0x50AB	LENC CTRL43	0x00	RW	Bit[7:2]: Not used Bit[1:0]: short_grn_y0[9:8]
0x50AC	LENC CTRL44	0x00	RW	Bit[7:0]: short_grn_y0[7:0]
0x50AD	LENC CTRL45	0x00	RW	Bit[7]: Not used Bit[6:0]: short_grn_a1

table 7-9 LENC control registers (sheet 4 of 4)

address	register name	default value	R/W	description
0x50AE	LENC CTRL46	0x01	RW	Bit[7:4]: Not used Bit[3:0]: short_grn_a2
0x50AF	LENC CTRL47	0x00	RW	Bit[7]: short_grn_sign Bit[6:0]: short_grn_b1
0x50B0	LENC CTRL48	0x01	RW	Bit[7:4]: Not used Bit[3:0]: short_grn_b2
0x50B1	LENC CTRL49	0x00	RW	Bit[7:3]: Not used Bit[2:0]: short_blu_x0[10:8]
0x50B2	LENC CTRL50	0x00	RW	Bit[7:0]: short_blu_x0[7:0]
0x50B3	LENC CTRL51	0x00	RW	Bit[7:2]: Not used Bit[1:0]: short_blu_y0[9:8]
0x50B4	LENC CTRL52	0x00	RW	Bit[7:0]: short_blu_y0[7:0]
0x50B5	LENC CTRL53	0x00	RW	Bit[7]: Not used Bit[6:0]: short_blu_a1
0x50B6	LENC CTRL54	0x01	RW	Bit[7:4]: Not used Bit[3:0]: short_blu_a2
0x50B7	LENC CTRL55	0x00	RW	Bit[7]: short_blu_sign Bit[6:0]: short_blu_b1
0x50B8	LENC CTRL56	0x01	RW	Bit[7:4]: Not used Bit[3:0]: short_blu_b2

7.10 white/black pixel cancellation [0x50C1 - 0x50ED, 0x5180 - 0x51A3]

table 7-10 white/black pixel cancellation registers (sheet 1 of 4)

address	register name	default value	R/W	description
0x50C1	OTP CTRL L01	0x00	RW	Bit[7:6]: Not used Bit[5:0]: Start address of OTP memory
0x50C3	OTP CTRL L03	0x00	RW	Bit[7:6]: Not used Bit[5:0]: End address of OTP memory for long channel
0x50C4	OTP CTRL L04	0x02	RW	Bit[7:6]: Not used Bit[5:0]: Start address of OTP memory for long channel

table 7-10 white/black pixel cancellation registers (sheet 2 of 4)

address	register name	default value	R/W	description
0x50C5	OTP CTRL L05	0x6F	RW	Bit[7:6]: Not used Bit[5:0]: End address of OTP memory for long channel
0x50C6	OTP CTRL L06	0x00	RW	Bit[7:6]: Not used Bit[5]: Non-HDR mode reverse for long channel Bit[4]: Manual increase step enable for long channel Bit[3]: Disable mirror and flip option for long channel Bit[2]: Disable OTP offset option for long channel Bit[1]: Mirror option for long channel Bit[0]: Disable binning option for long channel
0x50C7	OTP CTRL L07	0x00	RW	Bit[7:3]: Cluster cancellation option for long channel Bit[2]: Flip option for long channel Bit[1]: Sensor exposure constrain enable for long channel Bit[0]: Sensor gain constrain enable for long channel
0x50C8	OTP CTRL L08	0x07	RW	Bit[7:0]: Exposure constrain[15:8] for long channel
0x50C9	OTP CTRL L09	0x08	RW	Bit[7:0]: Exposure constrain[7:0] for long channel
0x50CA	OTP CTRL L0A	0x01	RW	Bit[7:6]: Not used Bit[5:0]: Gain constrain for long channel
0x50CB	OTP CTRL L0B	0x01	RW	Bit[7:4]: Not used Bit[3:0]: Recover threshold for long channel
0x50CC	OTP CTRL L0C	0x01	RW	Bit[7:5]: Not used Bit[4:0]: Manual x even increase step for long channel
0x50CD	OTP CTRL L0D	0x01	RW	Bit[7:5]: Not used Bit[4:0]: Manual x odd increase step for long channel
0x50E1	OTP CTRL S01	0x00	RW	Bit[7:5]: Not used Bit[4:0]: Manual y even increase step for long channel
0x50E3	OTP CTRL S03	0x00	RW	Bit[7:5]: Not used Bit[4:0]: Manual y odd increase step for long channel
0x50E4	OTP CTRL S04	0x02	RW	Bit[7:6]: Not used Bit[5:0]: Start address of OTP memory for short channel

table 7-10 white/black pixel cancellation registers (sheet 3 of 4)

address	register name	default value	R/W	description
0x50E5	OTP CTRL S05	0x6F	RW	Bit[7:6]: Not used Bit[5:0]: End address of OTP memory for short channel
0x50E6	OTP CTRL S06	0x00	RW	Bit[7:6]: Debug mode Bit[5]: Non-HDR mode reverse for short channel Bit[4]: Manual increase step enable for short channel Bit[3]: Disable mirror and flip option for short channel Bit[2]: Disable OTP offset option for short channel Bit[1]: Mirror option for short channel Bit[0]: Disable binning option for short channel
0x50E7	OTP CTRL S07	0x00	RW	Bit[7:3]: Cluster cancellation option for short channel Bit[2]: Flip option for short channel Bit[1]: Sensor exposure constrain enable for short channel Bit[0]: Sensor gain constrain enable for short channel
0x50E8	OTP CTRL S08	0x07	RW	Bit[7:0]: Exposure constrain[15:8] for short channel
0x50E9	OTP CTRL S09	0x08	RW	Bit[7:0]: Exposure constrain[7:0] for short channel
0x50EA	OTP CTRL S0A	0x01	RW	Bit[7:6]: Not used Bit[5:0]: Gain constrain for short channel
0x50EB	OTP CTRL S0B	0x01	RW	Bit[7:4]: Not used Bit[3:0]: Recover threshold for short channel
0x50EC	OTP CTRL S0C	0x01	RW	Bit[7:5]: Not used Bit[4:0]: Manual x even increase step for short channel
0x50ED	OTP CTRL S0D	0x01	RW	Bit[7:5]: Not used Bit[4:0]: Manual x odd increase step for short channel
0x5180	WBC CTRL00	0x1C	RW	Bit[7:5]: Not used Bit[4:0]: Manual y even increase step for short channel
0x5181	WBC CTRL01	0x13	RW	Bit[7:5]: Not used Bit[4:0]: Manual y odd increase step for short channel
0x5182~ 0x5191	DEBUG CTRL	–	RW	Debug Registers for Long Channel

table 7-10 white/black pixel cancellation registers (sheet 4 of 4)

address	register name	default value	R/W	description
0x5192	WBC CTRL12	0x1C	RW	Bit[7:5]: Not used Bit[4]: Debug mode Bit[3:2]: Not used Bit[1:0]: Option for padding boundary pixel for long channel
0x5193	WBC CTRL13	0x13	RW	WBC Debug Control for Long Channel
0x5194~ 0x51A3	DEBUG CTRL	–	RW	Debug Registers for Short Channel

7.11 AWB [0x5100 - 0x5718, 0xC4B8 - 0xC4DF, 0x5AB0 - 0x5D1B]

table 7-11 AWB control registers (sheet 1 of 14)

address	register name	default value	R/W	description
0x5100	GAIN AWB CTRL0	0x00	RW	Bit[7:2]: Not used Bit[1:0]: manual_gain_b_long[9:8]
0x5101	GAIN AWB CTRL1	0x80	RW	Bit[7:0]: manual_gain_b_long[7:0]
0x5102	GAIN AWB CTRL2	0x00	RW	Bit[7:2]: Not used Bit[1:0]: manual_gain_gb_long[9:8]
0x5103	GAIN AWB CTRL3	0x80	RW	Bit[7:0]: manual_gain_gb_long[7:0]
0x5104	GAIN AWB CTRL4	0x00	RW	Bit[7:2]: Not used Bit[1:0]: manual_gain_gr_long[9:8]
0x5105	GAIN AWB CTRL5	0x80	RW	Bit[7:0]: manual_gain_gr_long[7:0]
0x5106	GAIN AWB CTRL6	0x00	RW	Bit[7:2]: Not used Bit[1:0]: manual_gain_r_long[9:8]
0x5107	GAIN AWB CTRL7	0x80	RW	Bit[7:0]: manual_gain_r_long[7:0]
0x5108	GAIN AWB CTRL8	0x00	RW	Bit[7:2]: Not used Bit[1:0]: manual_offset_b_long[9:8]
0x5109	GAIN AWB CTRL9	0x00	RW	Bit[7:0]: manual_offset_b_long[7:0]
0x510A	GAIN AWB CTRL10	0x00	RW	Bit[7:2]: Not used Bit[1:0]: manual_offset_gb_long[9:8]
0x510B	GAIN AWB CTRL11	0x00	RW	Bit[7:0]: manual_offset_gb_long[7:0]
0x510C	GAIN AWB CTRL12	0x00	RW	Bit[7:2]: Not used Bit[1:0]: manual_offset_gr_long[9:8]

table 7-11 AWB control registers (sheet 2 of 14)

address	register name	default value	R/W	description
0x510D	GAIN AWB CTRL13	0x00	RW	Bit[7:0]: manual_offset_gr_long[7:0]
0x510E	GAIN AWB CTRL14	0x00	RW	Bit[7:2]: Not used Bit[1:0]: manual_offset_r_long[9:8]
0x510F	GAIN AWB CTRL15	0x00	RW	Bit[7:0]: manual_offset_r_long[7:0]
0x5110	GAIN AWB CTRL16	0x00	RW	Bit[7:2]: Not used Bit[1:0]: manual_gain_b_short[9:8]
0x5111	GAIN AWB CTRL17	0x80	RW	Bit[7:0]: manual_gain_b_short[7:0]
0x5112	GAIN AWB CTRL18	0x00	RW	Bit[7:2]: Not used Bit[1:0]: manual_gain_gb_short[9:8]
0x5113	GAIN AWB CTRL19	0x80	RW	Bit[7:0]: manual_gain_gb_short[7:0]
0x5114	GAIN AWB CTRL20	0x00	RW	Bit[7:2]: Not used Bit[1:0]: manual_gain_gr_short[9:8]
0x5115	GAIN AWB CTRL21	0x80	RW	Bit[7:0]: manual_gain_gr_short[7:0]
0x5116	GAIN AWB CTRL22	0x00	RW	Bit[7:2]: Not used Bit[1:0]: manual_gain_r_short[9:8]
0x5117	GAIN AWB CTRL23	0x80	RW	Bit[7:0]: manual_gain_r_short[7:0]
0x5118	GAIN AWB CTRL24	0x00	RW	Bit[7:2]: Not used Bit[1:0]: manual_offset_b_short[9:8]
0x5119	GAIN AWB CTRL25	0x00	RW	Bit[7:0]: manual_offset_b_short[7:0]
0x511A	GAIN AWB CTRL26	0x00	RW	Bit[7:2]: Not used Bit[1:0]: manual_offset_gb_short[9:8]
0x511B	GAIN AWB CTRL27	0x00	RW	Bit[7:0]: manual_offset_gb_short[7:0]
0x511C	GAIN AWB CTRL28	0x00	RW	Bit[7:2]: Not used Bit[1:0]: manual_offset_gr_short[9:8]
0x511D	GAIN AWB CTRL29	0x00	RW	Bit[7:0]: manual_offset_gr_short[7:0]
0x511E	GAIN AWB CTRL30	0x00	RW	Bit[7:2]: Not used Bit[1:0]: manual_offset_r_short[9:8]
0x511F	GAIN AWB CTRL31	0x00	RW	Bit[7:0]: manual_offset_r_short[7:0]
0x5120	GAIN AWB CTRL32	0x00	RW	Bit[7:1]: Not used Bit[0]: White balance (WB) mode select 0: Auto mode 1: Manual mode
0x5580	AWB CT CTRL0	0xFF	RW	Bit[7:0]: awb_b_block_l

table 7-11 AWB control registers (sheet 3 of 14)

address	register name	default value	R/W	description
0x5581	AWB CT CTRL1	0x5B	RW	Bit[7:6]: step_local Bit[5:4]: step_fast Bit[3]: slop_8x_l Bit[2]: slop_4x_l Bit[1]: one_zone Bit[0]: avg_all
0x5582	DEBUG MODE	–	–	Debug Mode
0x5583	AWB CT CTRL3	0x10	RW	Bit[7]: slop_8x_s Bit[6]: slop_4x_s Bit[5]: Not used Bit[4]: awb_simf Bit[3:2]: awb_win Bit[1:0]: Not used
0x5584~ 0x5585	DEBUG MODE	–	–	Debug Mode
0x5586	AWB_M_RNG	0x10	RW	Bit[7:0]: AWB_M_RNG[7:0] Tolerance of AWB_M_X and AWB_M_Y in middle color temperature range. Too small of a tolerance results in unstable AWB, while too great of a tolerance results in inaccurate AWB.
0x5587	AWB_L_XRNG	0x10	RW	Bit[7:0]: AWB_L_XRNG[7:0] Tolerance of AWB_L_X in low color temperature range, where AWB_L_X is X characteristics of gray object in low color temperature range. Too small of a tolerance results in unstable AWB, while too great of a tolerance results in inaccurate AWB. Typical value ranges from 0x08~0x18.
0x5588	AWB_H_YRNG	0x10	RW	Bit[7:0]: AWB_H_YRNG[7:0] Tolerance of AWB_H_Y in low color temperature range, where AWB_H_Y is Y characteristics of gray object in high color temperature range. Too small of a tolerance results in unstable AWB, while too great of a tolerance results in inaccurate white balance. Typical value ranges from 0x08~0x10.

table 7-11 AWB control registers (sheet 4 of 14)

address	register name	default value	R/W	description
0x5589	AWB_M_X	0x40	RW	<p>Bit[7:0]: AWB_M_X[7:0] X characteristics of gray object in middle color temperature range.</p> <p>When AWB_M_X increases, gray will shift toward blue in low color temperature light, or red in high color temperature light. When AWB_M_X decreases, gray will shift toward yellow in low color temperature light, or cyan in high color temperature light. If AWB_M_X is too big or too small, AWB algorithm may fail to identify gray object and result is not stable and unpredictable.</p>
0x558A	AWB_M_Y	0x40	RW	<p>Bit[7:0]: AWB_M_Y[7:0] Y characteristics of gray object in middle color temperature range.</p> <p>When AWB_M_Y increases, gray will shift toward blue in low color temperature light, or red in high color temperature light. When AWB_M_Y decreases, gray will shift toward yellow in low color temperature light, or cyan in high color temperature light. If AWB_M_Y is too big or too small, AWB algorithm will fail to identify gray object and result is not stable and unpredictable.</p>
0x558B	AWB_L_K	0x00	RW	<p>Bit[7:0]: AWB_L_K K characteristics of gray object in low color temperature range</p> <p>When AWB_L_K increases/decreases, gray color will slightly shift toward yellow/blue, respectively, in low color temperature range. In general, AWB_L_K should be no less than 0x80</p>
0x558C	AWB_H_K	0x00	RW	<p>Bit[7:0]: AWB_H_K K characteristics of gray object in high color temperature range</p> <p>When AWB_H_K increases/decreases, gray color will slightly shift toward cyan/red, respectively, in high color temperature range.</p>

table 7-11 AWB control registers (sheet 5 of 14)

address	register name	default value	R/W	description
0x558D	AWB_H_LMT	0x00	RW	<p>Bit[7:0]: AWB_H_LMT[7:0] Lower limit of AWB_H_X, where AWB_H_X is X characteristics of gray object in high color temperature range.</p> <p>Smaller AWB_H_LMT covers greater upper limit of color temperature; however, it also results in less accurate white balance</p>
0x558E	AWB_L_LMT	0x00	RW	<p>Bit[7:0]: AWB_L_LMT[7:0] Lower limit of AWB_L_Y, where AWB_L_Y is Y characteristics of gray object in low color temperature range.</p> <p>Smaller AWB_L_LMT covers smaller lower limit of color temperature; however, it also results in less accurate white balance.</p>
0x558F	AWB_DBG1	0x20	RW	<p>Bit[7:0]: AWB_DBG1 Debug control register, not effective in normal usage</p>
0x5590	AWB_DBG2	0x20	RW	<p>Bit[7:0]: AWB_DBG2 Debug control register, not effective in normal usage</p>
0x5591	AWB_DATA_ULMT	0xFF	RW	<p>Bit[7:0]: AWB_DATA_ULMT Pixels with output value greater than AWB_DATA_ULMT are excluded in AWB statistics</p>
0x5592	AWB_DATA_LLMT	0x00	RW	<p>Bit[7:0]: AWB_DATA_LLMT Pixels with output value smaller than AWB_DATA_LLMT are excluded in AWB statistics</p>
0x5596	AWB CT CTRL22	0x03	RW	<p>Bit[7]: awb_gain_m Bit[6]: Not used Bit[5]: awb_freeze Bit[4]: Not used Bit[3:2]: awb_sim_sel 00: awb_simple from after awb_gain 01: awb_simple from after raw_gma 10: awb_simple from after HDR 11: awb_simple from after awb_gain Bit[1]: fast_enable Bit[0]: awb_bias_stat</p>
0x5593~ 0x5595	DEBUG MODE	–	–	Debug Registers

table 7-11 AWB control registers (sheet 6 of 14)

address	register name	default value	R/W	description
0x5596	AWB CT CTRL22	0x03	RW	Bit[7]: awb_gain_m Bit[6]: Not used Bit[5]: awb_freeze Bit[4]: Not used Bit[3:2]: awb_sim_sel 00: awb_simple from after awb_gain 01: awb_simple from after raw_gma 10: awb_simple from after HDR 11: awb_simple from after awb_gain Bit[1]: fast_enable Bit[0]: awb_bias_stat
0x5597	AWB CT CTRL23	0x02	RW	Bit[7:0]: Local limit
0x559E	AWB CT CTRL30	0xFF	RW	Bit[7:0]: awb_b_block_s
0x559F	AWB_M_RNG	0x10	RW	Bit[7:0]: AWB_M_RNG[7:0] Tolerance of AWB_M_X and AWB_M_Y in middle color temperature range Too small of a tolerance results in unstable AWB, while too great of a tolerance results in inaccurate AWB.
0x55AF	AWB CT CTRL41	0x00	RW	Bit[7]: bsum_l_fix Bit[6]: gsum_l_fix Bit[5]: rsum_l_fix Bit[4]: bsum_s_fix Bit[3]: gsum_s_fix Bit[2]: rsum_s_fix Bit[1]: allcnt_l_fix Bit[0]: allcnt_s_fix
0x55A0	AWB_L_XRNG	0x10	RW	Bit[7:0]: AWB_L_XRNG[7:0] Tolerance of AWB_L_X in low color temperature range, where AWB_L_X is X characteristics of gray object in low color temperature range. Too small of a tolerance results in unstable AWB, while too great of a tolerance results in inaccurate AWB. Typical value ranges from 0x08~0x18.

table 7-11 AWB control registers (sheet 7 of 14)

address	register name	default value	R/W	description
0x55A1	AWB_H_YRNG	0x10	RW	<p>Bit[7:0]: AWB_H_YRNG[7:0] Tolerance of AWB_H_Y in low color temperature range, where AWB_H_Y is Y characteristics of gray object in high color temperature range.</p> <p>Too small of a tolerance results in unstable AWB, while too great of a tolerance results in inaccurate white balance. Typical value ranges from 0x08~0x10.</p>
0x55A2	AWB_M_X	0x40	RW	<p>Bit[7:0]: AWB_M_X[7:0] X characteristics of gray object in middle color temperature range.</p> <p>When AWB_M_X increases, gray will shift toward blue in low color temperature light, or red in high color temperature light. When AWB_M_X decreases, gray will shift toward yellow in low color temperature light, or cyan in high color temperature light. If AWB_M_X is too big or too small, AWB algorithm may fail to identify gray object and result is not stable and unpredictable.</p>
0x55A3	AWB_M_Y	0x40	RW	<p>Bit[7:0]: AWB_M_Y[7:0] Y characteristics of gray object in middle color temperature range.</p> <p>When AWB_M_Y increases, gray will shift toward blue in low color temperature light, or red in high color temperature light. When AWB_M_Y decreases, gray will shift toward yellow in low color temperature light, or cyan in high color temperature light. If AWB_M_Y is too big or too small, AWB algorithm will fail to identify gray object and result is not stable and unpredictable.</p>

table 7-11 AWB control registers (sheet 8 of 14)

address	register name	default value	R/W	description
0x55A4	AWB_L_K	0x00	RW	<p>Bit[7:0]: AWB_L_K K characteristics of gray object in low color temperature range</p> <p>When AWB_L_K increases/decreases, gray color will slightly shift toward yellow/blue, respectively, in low color temperature range. In general, AWB_L_K should be no less than 0x80</p>
0x55A5	AWB_H_K	0x00	RW	<p>Bit[7:0]: AWB_H_K K characteristics of gray object in high color temperature range</p> <p>When AWB_H_K increases/decreases, gray color will slightly shift toward cyan/red, respectively, in high color temperature range.</p>
0x55A6	AWB_H_LMT	0x00	RW	<p>Bit[7:0]: AWB_H_LMT[7:0] Lower limit of AWB_H_X, where AWB_H_X is X characteristics of gray object in high color temperature range.</p> <p>Smaller AWB_H_LMT covers greater upper limit of color temperature; however, it also results in less accurate white balance</p>
0x55A7	AWB_L_LMT	0x00	RW	<p>Bit[7:0]: AWB_L_LMT[7:0] Lower limit of AWB_L_Y, where AWB_L_Y is Y characteristics of gray object in low color temperature range.</p> <p>Smaller AWB_L_LMT covers smaller lower limit of color temperature; however, it also results in less accurate white balance.</p>
0x55A8	AWB_DBG1	0x20	RW	<p>Bit[7:0]: AWB_DBG1 Debug control register, not effective in normal usage</p>
0x55A9	AWB_DBG2	0x20	RW	<p>Bit[7:0]: AWB_DBG2 Debug control register, not effective in normal usage</p>
0x55AA	AWB_DATA_ULMT	0xFF	RW	<p>Bit[7:0]: AWB_DATA_ULMT Pixels with output value greater than AWB_DATA_ULMT are excluded in AWB statistics</p>

table 7-11 AWB control registers (sheet 9 of 14)

address	register name	default value	R/W	description
0x55AB	AWB_DATA_LLMT	0x00	RW	Bit[7:0]: AWB_DATA_LLMT Pixels with output value smaller than AWB_DATA_LLMT are excluded in AWB statistics
0x55AC~ 0x55AE	AWB CTRL	–	–	Debug Registers
0x55AF	AWB CT CTRL41	0x00	RW	Bit[7]: bsum_l_fix Bit[6]: gsum_l_fix Bit[5]: rsum_l_fix Bit[4]: bsum_s_fix Bit[3]: gsum_s_fix Bit[2]: rsum_s_fix Bit[1]: allcnt_l_fix Bit[0]: allcnt_s_fix
0x55B0	AWB CT CTRL42	0x00	RW	Bit[7:6]: Not used Bit[5]: fix_whole Bit[4]: fix_eof Bit[3:0]: fix_value
0x5700	AWB CTRL0	0x00	RW	Bit[7:2]: Not used Bit[1:0]: midtone_ythre_l1[9:8]
0x5701	AWB CTRL1	0x10	RW	Bit[7:0]: midtone_ythre_l1[7:0] (midtone_ythre_l1+midtone_ythre_l2 ≤ 0x3FF)
0x5702	AWB CTRL2	0x01	RW	Bit[7:2]: Not used Bit[1:0]: midtone_ythre_l2[9:8]
0x5703	AWB CTRL3	0x00	RW	Bit[7:0]: midtone_ythre_l2[7:0] (midtone_ythre_l1+midtone_ythre_l2 ≤ 0x3FF)
0x5704	AWB CTRL4	0x03	RW	Bit[7:2]: Not used Bit[1:0]: midtone_ythre_h1[9:8]
0x5705	AWB CTRL5	0x68	RW	Bit[7:0]: midtone_ythre_h1[7:0] (midtone_ythre_h1+midtone_ythre_h2 ≤ 0x3FF)
0x5706	AWB CTRL6	0x00	RW	Bit[7:2]: Not used Bit[1:0]: midtone_ythre_h2[9:8]
0x5707	AWB CTRL7	0x80	RW	Bit[7:0]: midtone_ythre_h2[7:0] (midtone_ythre_h1+midtone_ythre_h2 ≤ 0x3FF)
0x5708	AWB CTRL8	0x00	RW	Bit[7:2]: Not used Bit[1:0]: gamma_ythre_l[9:8]
0x5709	AWB CTRL9	0x20	RW	Bit[7:0]: gamma_ythre_l[7:0]

table 7-11 AWB control registers (sheet 10 of 14)

address	register name	default value	R/W	description
0x570A	AWB CTRL10	0x00	RW	Bit[7:2]: Not used Bit[1:0]: gamma_ythre_h[9:8]
0x570B	AWB CTRL11	0x10	RW	Bit[7:0]: gamma_ythre_h[7:0]
0x570C	AWB CTRL12	0x00	RW	Bit[7:2]: Not used Bit[1:0]: gamma_uvthre1[9:8]
0x570D	AWB CTRL13	0x40	RW	Bit[7:0]: gamma_uvthre1[7:0]
0x570E	AWB CTRL14	0x00	RW	Bit[7:2]: Not used Bit[1:0]: gamma_uvthre2[9:8]
0x570F	AWB CTRL15	0x40	RW	Bit[7:0]: gamma_uvthre2[7:0]
0x5710	AWB CTRL16	0x00	RW	Bit[7:2]: Not used Bit[1:0]: shadow_ythre1[9:8]
0x5711	AWB CTRL17	0x40	RW	Bit[7:0]: shadow_ythre1[7:0] (shadow_ythre1 + shadow_ythre2 ≤ 0x3FF)
0x5712	AWB CTRL18	0x00	RW	Bit[7:2]: Not used Bit[1:0]: shadow_ythre2[9:8]
0x5713	AWB CTRL19	0x80	RW	Bit[7:0]: shadow_ythre2[7:0] (shadow_ythre1 + shadow_ythre2 ≤ 0x3FF)
0x5714	AWB CTRL20	0x00	RW	Bit[7:2]: Not used Bit[1:0]: shadow_uv_thre1[9:8]
0x5715	AWB CTRL21	0x10	RW	Bit[7:0]: shadow_uv_thre1[7:0] (shadow_uv_thre1 + shadow_uv_thre2 ≤ 0x3FF)
0x5716	AWB CTRL22	0x00	RW	Bit[7:2]: Not used Bit[1:0]: shadow_uv_thre2[9:8]
0x5717	AWB CTRL23	0x10	RW	Bit[7:0]: shadow_uv_thre2[7:0] (shadow_uv_thre1 + shadow_uv_thre2 ≤ 0x3FF)
0x5718	AWB CTRL24	0x3C	RW	Bit[7:6]: Not used Bit[5:2]: Debug mode Bit[1]: Debug mode 2 (EOF to VSYNC fixed value, other than zero) Bit[0]: Debug mode 1 (always fixed value)

table 7-11 AWB control registers (sheet 11 of 14)

address	register name	default value	R/W	description
0xC4B8	CT_AWB_EN	–	RW	Bit[7:1]: Not used Bit[0]: Color temperature based AWB 0: Disable 1: Enable When register value is 0x00, it means function is disabled; all other values mean function is enabled. This register value must be initialized by user and must not be removed from start up sequence. Default value is random.
0xC4B9	AWB_WORK_MODE	–	RW	Bit[7:2]: Not used Bit[1:0]: AWB work mode 00: Separate mode 01: Long 10: Short 11: Combine This register value must be initialized by user and must not be removed from start up sequence. Default value is random.
0xC4BA	AWB_FEEDBACK_EN	–	RW	Bit[7:1]: Not used Bit[0]: Feedback for simple AWB 0: Disable 1: Enable When register value is 0x00, it means function is disabled; all other values mean function is enabled. This register value must be initialized by user and must not be removed from start up sequence. Default value is random.
0xC4BB	DEBUG MODE	–	–	Debug Mode
0xC4CC	SIMPLE_MIN_NUM_1	–	RW	Bit[7:0]: Min statistic num for simple AWB[15:8] This register value must be initialized by user and must not be removed from start up sequence. Default value is random.
0xC4CD	SIMPLE_MIN_NUM_2	–	RW	Bit[7:0]: Min statistic num for simple AWB[7:0] This register value must be initialized by user and must not be removed from start up sequence. Default value is random.
0xC4CE	CT_MIN_NUM_1	–	RW	Bit[7:0]: Min statistic num for CT AWB[15:8] This register value must be initialized by user and must not be removed from start up sequence. Default value is random.

table 7-11 AWB control registers (sheet 12 of 14)

address	register name	default value	R/W	description
				Bit[7:0]: Min statistic num for CT AWB[7:0]
0xC4CF	CT_MIN_NUM_2	–	RW	This register value must be initialized by user and must not be removed from start up sequence. Default value is random.
				Relative AWB Adjustment Step
0xC4D0	AWB_STEP_1	–	RW	This register value must be initialized by user and must not be removed from start up sequence. Default value is random.
				Absolute AWB Adjustment Step
0xC4D1	AWB_STEP_2	–	RW	This register value must be initialized by user and must not be removed from start up sequence. Default value is random.
0xC4D2~ 0xC4DF	DEBUG MODE	–	–	Debug Registers
0x5AB0~ 0x5B1B	AWB_R	–	R	Debug Information for AWB Gain Control
0x5CFC	WBG_R01	–	R	Bit[7:2]: Not used Bit[1:0]: Long_AWB_gain_B[9:8]
0x5CFD	WBG_R02	–	R	Bit[7:0]: Long_AWB_gain_B[7:0]
0x5CFE	WBG_R03	–	R	Bit[7:2]: Not used Bit[1:0]: Long_AWB_gain_Gb[9:8]
0x5CFF	WBG_R04	–	R	Bit[7:0]: Long_AWB_gain_Gb[7:0]
0x5D00	WBG_R05	–	R	Bit[7:2]: Not used Bit[1:0]: Long_AWB_gain_Gr[9:8]
0x5D01	WBG_R06	–	R	Bit[7:0]: Long_AWB_gain_Gr[7:0]
0x5D02	WBG_R07	–	R	Bit[7:2]: Not used Bit[1:0]: Long_AWB_gain_R[9:8]
0x5D03	WBG_R08	–	R	Bit[7:0]: Long_AWB_gain_R[7:0]
0x5D04	WBG_R09	–	R	Bit[7:2]: Not used Bit[1:0]: Short_AWB_gain_B[9:8]
0x5D05	WBG_R10	–	R	Bit[7:0]: Short_AWB_gain_B[7:0]
0x5D06	WBG_R11	–	R	Bit[7:2]: Not used Bit[1:0]: Short_AWB_gain_Gb[9:8]
0x5D07	WBG_R12	–	R	Bit[7:0]: Short_AWB_gain_Gb[7:0]

table 7-11 AWB control registers (sheet 13 of 14)

address	register name	default value	R/W	description
0x5D08	WBG_R13	–	R	Bit[7:2]: Not used Bit[1:0]: Short_AWB_gain_Gr[9:8]
0x5D09	WBG_R14	–	R	Bit[7:0]: Short_AWB_gain_Gr[7:0]
0x5D0A	WBG_R15	–	R	Bit[7:2]: Not used Bit[1:0]: Short_AWB_gain_R[9:8]
0x5D0B	WBG_R16	–	R	Bit[7:0]: Short_AWB_gain_R[7:0]
0x5D0C	WBG_R17	–	R	Bit[7:2]: Not used Bit[1:0]: Long_AWBoffset_B[9:8] Complementary code
0x5D0D	WBG_R18	–	R	Bit[7:0]: Long_AWBoffset_B[7:0] Complementary code
0x5D0E	WBG_R19	–	R	Bit[7:2]: Not used Bit[1:0]: Long_AWBoffset_GB[9:8] Complementary code
0x5D0F	WBG_R20	–	R	Bit[7:0]: Long_AWBoffset_GB[7:0] Complementary code
0x5D10	WBG_R21	–	R	Bit[7:2]: Not used Bit[1:0]: Long_AWBoffset_GR[9:8] Complementary code
0x5D11	WBG_R22	–	R	Bit[7:0]: Long_AWBoffset_GR[7:0] Complementary code
0x5D12	WBG_R23	–	R	Bit[7:2]: Not used Bit[1:0]: Long_AWBoffset_R[9:8] Complementary code
0x5D13	WBG_R24	–	R	Bit[7:0]: Long_AWBoffset_R[7:0] Complementary code
0x5D14	WBG_R25	–	R	Bit[7:2]: Not used Bit[1:0]: Short_AWBoffset_B[9:8] Complementary code
0x5D15	WBG_R26	–	R	Bit[7:0]: Short_AWBoffset_B[7:0] Complementary code
0x5D16	WBG_R27	–	R	Bit[7:2]: Not used Bit[1:0]: Short_AWBoffset_Gb[9:8] Complementary code
0x5D17	WBG_R28	–	R	Bit[7:0]: Short_AWBoffset_Gb[7:0] Complementary code
0x5D18	WBG_R29	–	R	Bit[7:2]: Not used Bit[1:0]: Short_AWBoffset_Gr[9:8] Complementary code

table 7-11 AWB control registers (sheet 14 of 14)

address	register name	default value	R/W	description
0x5D19	WBG_R30	–	R	Bit[7:0]: Short_AWBoffset_Gr[7:0] Complementary code
0x5D1A	WBG_R31	–	R	Bit[7:2]: Not used Bit[1:0]: Short_AWBoffset_R[9:8] Complementary code
0x5D1B	WBG_R32	–	R	Bit[7:0]: Short_AWBoffset_R[7:0] Complementary code

7.12 DNS control [0x5210 - 0x522F, 0x5238 - 0x5256]

table 7-12 DNS control registers (sheet 1 of 4)

address	register name	default value	R/W	description
0x5210	DNS CTRL10	0x04	RW	Bit[7:4]: Not used Bit[3:0]: noise_y_a for long exposure sub-pixel
0x5211	DNS CTRL11	0x08	RW	Bit[7:5]: Not used Bit[4:0]: noise_uv_a for long exposure sub-pixel
0x5212	DNS CTRL12	0x00	RW	Bit[7:1]: Not used Bit[0]: dns_manual for long exposure sub-pixel
0x5213	DNS CTRL13	0x02	RW	Bit[7:0]: noise_y for long exposure sub-pixel
0x5214	DNS CTRL14	0x00	RW	Bit[7:1]: Not used Bit[0]: noise_u[8] for long exposure sub-pixel
0x5215	DNS CTRL15	0x02	RW	Bit[7:0]: noise_u[7:0] for long exposure sub-pixel
0x5216	DNS CTRL16	0x00	RW	Bit[7:1]: Not used Bit[0]: noise_v[8] for long exposure sub-pixel
0x5217	DNS CTRL17	0x02	RW	Bit[7:0]: noise_v[7:0] for long exposure sub-pixel
0x5218	DNS CTRL18	0x06	RW	Bit[7:0]: dns_edgethre for long exposure sub-pixel
0x5219	DNS CTRL19	0x04	RW	Bit[7:3]: Not used Bit[2:0]: dns_gbgr_extra[2:0] for long exposure sub-pixel
0x521A	DNS CTRL20	0x02	RW	Bit[7:0]: noise_y_list_0 for long exposure sub-pixel
0x521B	DNS CTRL21	0x04	RW	Bit[7:0]: noise_y_list_1 for long exposure sub-pixel
0x521C	DNS CTRL22	0x08	RW	Bit[7:0]: noise_y_list_2 for long exposure sub-pixel
0x521D	DNS CTRL23	0x14	RW	Bit[7:0]: noise_y_list_3 for long exposure sub-pixel

table 7-12 DNS control registers (sheet 2 of 4)

address	register name	default value	R/W	description
0x521E	DNS CTRL24	0x1E	RW	Bit[7:0]: noise_y_list_4 for long exposure sub-pixel
0x521F	DNS CTRL25	0x28	RW	Bit[7:0]: noise_y_list_5 for long exposure sub-pixel
0x5220	DNS CTRL26	0x32	RW	Bit[7:0]: noise_y_list_6_l for long exposure sub-pixel
0x5221	DNS CTRL27	0x00	RW	Bit[7:1]: Not used Bit[0]: dns_dummy[0] for long exposure sub-pixel
0x5222	DNS CTRL28	0x00	RW	Bit[7:1]: Not used Bit[0]: noise_uv_list_0[8] for long exposure sub-pixel
0x5223	DNS CTRL29	0x02	RW	Bit[7:0]: noise_uv_list_0[7:0] for long exposure sub-pixel
0x5224	DEBUG MODE	–	–	Debug Mode
0x5225	DNS CTRL31	0x04	RW	Bit[7:0]: noise_uv_list_1[7:0] for long exposure sub-pixel
0x5226	DNS CTRL32	0x00	RW	Bit[7:1]: Not used Bit[0]: noise_uv_list_2[8] for long exposure sub-pixel
0x5227	DNS CTRL33	0x0C	RW	Bit[7:0]: noise_uv_list_2[7:0] for long exposure sub-pixel
0x5228	DNS CTRL34	0x00	RW	Bit[7:1]: Not used Bit[0]: noise_uv_list_3[8] for long exposure sub-pixel
0x5229	DNS CTRL35	0x28	RW	Bit[7:0]: noise_uv_list_3[7:0] for long exposure sub-pixel
0x522A	DNS CTRL36	0x00	RW	Bit[7:1]: Not used Bit[0]: noise_uv_list_4[8] for long exposure sub-pixel
0x522B	DNS CTRL37	0x32	RW	Bit[7:0]: noise_uv_list_4[7:0] for long exposure sub-pixel
0x522C	DNS CTRL38	0x00	RW	Bit[7:1]: Not used Bit[0]: noise_uv_list_5[8] for long exposure sub-pixel
0x522D	DNS CTRL39	0x3C	RW	Bit[7:0]: noise_uv_list_5[7:0] for long exposure sub-pixel
0x522E	DNS CTRL40	0x00	RW	Bit[7:1]: Not used Bit[0]: noise_uv_list_6[8] for long exposure sub-pixel
0x522F	DNS CTRL41	0x4C	RW	Bit[7:0]: noise_uv_list_6[7:0] for long exposure sub-pixel
0x5238	DNS CTRL50	0x04	RW	Bit[7:4]: Not used Bit[3:0]: noise_y_a for short exposure sub-pixel
0x5239	DNS CTRL51	0x08	RW	Bit[7:5]: Not used Bit[4:0]: noise_uv_a for short exposure sub-pixel
0x523A	DNS CTRL52	0x00	RW	Bit[7:1]: Not used Bit[0]: dns_manual for short exposure sub-pixel
0x523B	DNS CTRL53	0x02	RW	Bit[7:0]: noise_y for short exposure sub-pixel
0x523C	DNS CTRL54	0x00	RW	Bit[7:1]: Not used Bit[0]: noise_u[8] for short exposure sub-pixel

table 7-12 DNS control registers (sheet 3 of 4)

address	register name	default value	R/W	description
0x523D	DNS CTRL55	0x02	RW	Bit[7:0]: noise_u[7:0] for short exposure sub-pixel
0x523E	DNS CTRL56	0x00	RW	Bit[7:1]: Not used Bit[0]: noise_v[8] for short exposure sub-pixel
0x523F	DNS CTRL57	0x02	RW	Bit[7:0]: noise_v[7:0] for short exposure sub-pixel
0x5240	DNS CTRL58	0x06	RW	Bit[7:0]: dns_edgethre for short exposure sub-pixel
0x5241	DNS CTRL59	0x04	RW	Bit[7:3]: Not used Bit[2:0]: dns_gbgr_extra[2:0] for short exposure sub-pixel
0x5242	DNS CTRL60	0x02	RW	Bit[7:0]: noise_y_list_0 for short exposure sub-pixel
0x5243	DNS CTRL61	0x04	RW	Bit[7:0]: noise_y_list_1 for short exposure sub-pixel
0x5244	DNS CTRL62	0x08	RW	Bit[7:0]: noise_y_list_2 for short exposure sub-pixel
0x5245	DNS CTRL63	0x14	RW	Bit[7:0]: noise_y_list_3 for short exposure sub-pixel
0x5246	DNS CTRL64	0x1E	RW	Bit[7:0]: noise_y_list_4 for short exposure sub-pixel
0x5247	DNS CTRL65	0x28	RW	Bit[7:0]: noise_y_list_5 for short exposure sub-pixel
0x5248	DNS CTRL66	0x32	RW	Bit[7:0]: noise_y_list_6 for short exposure sub-pixel
0x5249	DNS CTRL67	0x00	RW	Bit[7:1]: Not used Bit[0]: noise_uv_list_0[8] for short exposure sub-pixel
0x524A	DNS CTRL68	0x02	RW	Bit[7:0]: noise_uv_list_0[7:0] for short exposure sub-pixel
0x524B	DNS CTRL69	0x00	RW	Bit[7:1]: Not used Bit[0]: noise_uv_list_1[8] for short exposure sub-pixel
0x524C	DNS CTRL70	0x04	RW	Bit[7:0]: noise_uv_list_1[7:0] for short exposure sub-pixel
0x524D	DNS CTRL71	0x00	RW	Bit[7:1]: Not used Bit[0]: noise_uv_list_2[8] for short exposure sub-pixel
0x524E	DNS CTRL72	0x0C	RW	Bit[7:0]: noise_uv_list_2[7:0] for short exposure sub-pixel
0x524F	DNS CTRL73	0x00	RW	Bit[7:1]: Not used Bit[0]: noise_uv_list_3[8] for short exposure sub-pixel
0x5250	DNS CTRL74	0x28	RW	Bit[7:0]: noise_uv_list_3[7:0] for short exposure sub-pixel
0x5251	DNS CTRL75	0x00	RW	Bit[7:1]: Not used Bit[0]: noise_uv_list_4[8] for short exposure sub-pixel

table 7-12 DNS control registers (sheet 4 of 4)

address	register name	default value	R/W	description
0x5252	DNS CTRL76	0x32	RW	Bit[7:0]: noise_uv_list_4[7:0] for short exposure sub-pixel
0x5253	DNS CTRL77	0x00	RW	Bit[7:1]: Not used Bit[0]: noise_uv_list_5[8] for short exposure sub-pixel
0x5254	DNS CTRL78	0x3C	RW	Bit[7:0]: noise_uv_list_5[7:0] for short exposure sub-pixel
0x5255	DNS CTRL79	0x00	RW	Bit[7:1]: Not used Bit[0]: noise_uv_list_6[8] for short exposure sub-pixel
0x5256	DNS CTRL80	0x4C	RW	Bit[7:0]: noise_uv_list_6[7:0] for short exposure sub-pixel

7.13 CIP control [0x5280 - 0x52A1, 0x52C0 - 0x52E1]

table 7-13 CIP control registers (sheet 1 of 7)

address	register name	default value	R/W	description
0x5280	CIP CTRL00	0x00	RW	Bit[7:2]: Not used Bit[1:0]: min_gain[9:8] for long exposure sub-pixel Min_gain is used in CIP_start module to judge in which range current sensor is in
0x5281	CIP CTRL01	0x10	RW	Bit[7:0]: min_gain[7:0] for long exposure sub-pixel Min_gain is used in CIP_start module to judge in which range current sensor is in
0x5282	CIP CTRL02	0x00	RW	Bit[7:2]: Not used Bit[1:0]: max_gain[9:8] for long exposure sub-pixel Max_gain is used in CIP_start module to judge in which range current sensor is in
0x5283	CIP CTRL03	0x80	RW	Bit[7:0]: max_gain[7:0] for long exposure sub-pixel Max_gain is used in CIP_start module to judge in which range current sensor is in
0x5284	CIP CTRL04	0x00	RW	Bit[7:1]: Not used Bit[0]: min_noise[8] for long exposure sub-pixel Min_noise is used for calculating int_noise in auto mode
0x5285	CIP CTRL05	0x10	RW	Bit[7:0]: min_noise[7:0] for long exposure sub-pixel Min_noise is used for calculating int_noise in auto mode

table 7-13 CIP control registers (sheet 2 of 7)

address	register name	default value	R/W	description
0x5286	CIP_CTRL06	0x01	RW	Bit[7:2]: Not used Bit[1:0]: noise_slope[9:8] for long exposure sub-pixel Slope value used for calculating int_noise in auto mode
0x5287	CIP_CTRL07	0x00	RW	Bit[7:0]: noise_slope[7:0] for long exposure sub-pixel Slope value used for calculating int_noise in auto mode
0x5288	CIP_CTRL08	0x10	RW	Bit[7:0]: unsharpen_mask0 for long exposure sub-pixel UnSharpenMask0 used in some filters as multipliers
0x5289	CIP_CTRL09	0x30	RW	Bit[7:0]: unsharpen_mask1 for long exposure sub-pixel UnSharpenMask0 used in some filters as multipliers
0x528A	CIP_CTRL0A	0x01	RW	Bit[7:2]: Not used Bit[1]: man_en Enable manual mode for long exposure sub-pixel anti_aliasing Bit[0]: anti_aliasing Enable anti-aliasing for long exposure sub-pixel
0x528B	CIP_CTRL0B	0x02	RW	Bit[7:4]: Not used Bit[3:0]: combine_alpha[3:0] for long exposure sub-pixel Combine coefficients for U, V and H components
0x528C	CIP_CTRL0C	0x00	RW	Bit[7:5]: Not used Bit[4:0]: min_sharpen[4:0] for long exposure sub-pixel Min_sharpen is used for sharpen_p calculation in auto mode
0x528D	CIP_CTRL0D	0x10	RW	Bit[7:6]: Not used Bit[5:0]: max_sharpen[5:0] for long exposure sub-pixel Max_sharpen is used for sharpen_p calculation in auto mode
0x528E	CIP_CTRL0E	0x10	RW	Bit[7:6]: Not used Bit[5:0]: min_sharpen_tp[5:0] for long exposure sub-pixel Min_sharpen_tp is used for sharpen_tp computation in auto mode
0x528F	CIP_CTRL0F	0x60	RW	Bit[7:0]: max_sharpen_tp[7:0] for long exposure sub-pixel Max_sharpen_tp is used for sharpen_tp computation in auto mode

table 7-13 CIP control registers (sheet 3 of 7)

address	register name	default value	R/W	description
0x5290	CIP CTRL10	0x20	RW	Bit[7:6]: Not used Bit[5:0]: min_sharpen_tm[5:0] for long exposure sub-pixel Min_sharpen_tm is used for sharpen_tm computation in auto mode
0x5291	CIP CTRL11	0x60	RW	Bit[7:0]: max_sharpen_tm[7:0] for long exposure sub-pixel Max_sharpen_tm is used for sharpen_tm computation in auto mode
0x5292	CIP CTRL12	0x40	RW	Bit[7:0]: sharpen_tya[7:0] for long exposure sub-pixel Threshold used for function of adaptive sharpen
0x5293	CIP CTRL13	0x10	RW	Bit[7:5]: Not used Bit[4:0]: sharpen_alpha[4:0] for long exposure sub-pixel Sharpen_alpha is used for calculating sharpen_m after sharpen_p is obtained
0x5294	CIP CTRL14	0x06	RW	Bit[7:6]: Not used Bit[5:0]: mthre[5:0] for long exposure sub-pixel Threshold for medium frequency signals
0x5295	CIP CTRL15	0x08	RW	Bit[7:6]: Not used Bit[5:0]: hthre[5:0] for long exposure sub-pixel Threshold for high frequency signals
0x5297	CIP CTRL17	0x06	RW	Bit[7:4]: Not used Bit[3:0]: hfreq_coef[3:0] for long exposure sub-pixel Coefficients for high frequency signals
0x5298	CIP CTRL18	0x00	RW	Bit[7:2]: Not used Bit[1:0]: efreq_coef[1:0] for long exposure sub-pixel Coefficients for E frequency signals
0x5299	CIP CTRL19	0x08	RW	Bit[7:6]: Not used Bit[5:0]: lthre[5:0] for long exposure sub-pixel Threshold for low frequency signals
0x529A	CIP CTRL1A	0x00	RW	Bit[7:2]: Not used Bit[1:0]: man_int_noise[9:8] for long exposure sub-pixel Int_noise is input only in manual mode and is used as threshold in some filters
0x529B	CIP CTRL1B	0x30	RW	Bit[7:0]: man_int_noise[7:0] for long exposure sub-pixel Int_noise is input only in manual mode and is used as threshold in some filters
0x529C	CIP CTRL1C	0x00	RW	Bit[7:1]: Not used Bit[0]: man_inv_noise[8] for long exposure sub-pixel Inv_noise is input only in manual mode and is used as threshold in some filters

table 7-13 CIP control registers (sheet 4 of 7)

address	register name	default value	R/W	description
0x529D	CIP CTRL1D	0x55	RW	Bit[7:0]: man_inv_noise[7:0] for long exposure sub-pixel Inv_noise is input only in manual mode and is used as threshold in some filters
0x529E	CIP CTRL1E	0x08	RW	Bit[7:6]: Not used Bit[5:0]: man_sharpen_p[5:0] for long exposure sub-pixel Sharpen_p is input only in manual mode and is used for function of adaptive sharpen
0x529F	CIP CTRL1F	0x08	RW	Bit[7]: Not used Bit[6:0]: man_sharpen_m[6:0] for long exposure sub-pixel Sharpen_m is input only in manual mode and is used for function of adaptive sharpen
0x52A0	CIP CTRL20	0x06	RW	Bit[7:0]: man_sharpen_tp[7:0] for long exposure sub-pixel Sharpen_tp is input only in manual mode and is used for function of adaptive sharpen
0x52A1	CIP CTRL21	0x08	RW	Bit[7:0]: man_sharpen_tm[7:0] for long exposure sub-pixel Sharpen_tm is input only in manual mode and is used for function of adaptive sharpen
0x52C0	CIP CTRL40	0x00	RW	Bit[7:2]: Not used Bit[1:0]: min_gain[9:8] for short exposure sub-pixel Min_gain is used in CIP_start module to judge in which range current sensor is in
0x52C1	CIP CTRL41	0x10	RW	Bit[7:0]: min_gain[7:0] for short exposure sub-pixel Min_gain is used in CIP_start module to judge in which range current sensor is in
0x52C2	CIP CTRL42	0x00	RW	Bit[7:2]: Not used Bit[1:0]: max_gain[9:8] for short exposure sub-pixel Max_gain is used in CIP_start module to judge in which range current sensor is in
0x52C3	CIP CTRL43	0x80	RW	Bit[7:0]: max_gain[7:0] for short exposure sub-pixel Max_gain is used in CIP_start module to judge in which range current sensor is in
0x52C4	CIP CTRL44	0x00	RW	Bit[7:1]: Not used Bit[0]: min_noise[8] for short exposure sub-pixel Min_noise is used for calculating int_noise in auto mode
0x52C5	CIP CTRL45	0x10	RW	Bit[7:0]: min_noise[7:0] for short exposure sub-pixel Min_noise is used for calculating int_noise in auto mode

table 7-13 CIP control registers (sheet 5 of 7)

address	register name	default value	R/W	description
0x52C6	CIP CTRL46	0x01	RW	Bit[7:2]: Not used Bit[1:0]: noise_slope[9:8] for short exposure sub-pixel Slope value used for calculating int_noise in auto mode
0x52C7	CIP CTRL47	0x00	RW	Bit[7:0]: noise_slope[7:0] for short exposure sub-pixel Slope value used for calculating int_noise in auto mode
0x52C8	CIP CTRL48	0x10	RW	Bit[7:0]: unsharpen_mask0 for short exposure sub-pixel UnSharpenMask0 used in some filters as multipliers
0x52C9	CIP CTRL49	0x30	RW	Bit[7:0]: unsharpen_mask1 for short exposure sub-pixel UnSharpenMask0 used in some filters as multipliers
0x52CA	CIP CTRL4A	0x01	RW	Bit[7:2]: Not used Bit[1]: man_en Enable manual mode for short exposure sub-pixel Bit[0]: anti_aliasing for short exposure sub-pixel Enable anti-aliasing
0x52CB	CIP CTRL4B	0x02	RW	Bit[7:4]: Not used Bit[3:0]: combine_alpha[3:0] for short exposure sub-pixel Combine coefficients for U, V and H components
0x52CC	CIP CTRL4C	0x00	RW	Bit[7:5]: Not used Bit[4:0]: min_sharpen[4:0] for short exposure sub-pixel Min_sharpen is used for sharpen_p calculation in auto mode
0x52CD	CIP CTRL4D	0x00	RW	Bit[7:6]: Not used Bit[5:0]: max_sharpen[5:0] for short exposure sub-pixel Max_sharpen is used for sharpen_p calculation in auto mode
0x52CE	CIP CTRL4E	0x10	RW	Bit[7:6]: Not used Bit[5:0]: min_sharpen_tp[5:0] for short exposure sub-pixel Min_sharpen_tp is used for sharpen_tp computation in auto mode
0x52CF	CIP CTRL4F	0x60	RW	Bit[7:0]: max_sharpen_tp[7:0] for short exposure sub-pixel Max_sharpen_tp is used for sharpen_tp computation in auto mode

table 7-13 CIP control registers (sheet 6 of 7)

address	register name	default value	R/W	description
0x52D0	CIP CTRL50	0x20	RW	Bit[7:6]: Not used Bit[5:0]: min_sharpen_tm[5:0] for short exposure sub-pixel Min_sharpen_tm is used for sharpen_tm computation in auto mode
0x52D1	CIP CTRL51	0x60	RW	Bit[7:0]: max_sharpen_tm[7:0] for short exposure sub-pixel Max_sharpen_tm is used for sharpen_tm computation in auto mode
0x52D2	CIP CTRL52	0x40	RW	Bit[7:0]: sharpen_tya[7:0] for short exposure sub-pixel Threshold used for function of adaptive sharpen
0x52D3	CIP CTRL53	0x10	RW	Bit[7:5]: Not used Bit[4:0]: sharpen_alpha[4:0] for short exposure sub-pixel Sharpen_alpha is used for calculating sharpen_m after sharpen_p is obtained
0x52D4	CIP CTRL54	0x06	RW	Bit[7:6]: Not used Bit[5:0]: mthre[5:0] for short exposure sub-pixel Threshold for medium frequency signals
0x52D5	CIP CTRL55	0x08	RW	Bit[7:6]: Not used Bit[5:0]: hthre[5:0] for short exposure sub-pixel Threshold for high frequency signals
0x52D7	CIP CTRL57	0x06	RW	Bit[7:4]: Not used Bit[3:0]: hfreq_coef[3:0] for short exposure sub-pixel Coefficients for high frequency signals
0x52D8	CIP CTRL58	0x00	RW	Bit[7:2]: Not used Bit[1:0]: efreq_coef[1:0] for short exposure sub-pixel Coefficients for E frequency signals
0x52D9	CIP CTRL59	0x08	RW	Bit[7:6]: Not used Bit[5:0]: lthre[5:0] for short exposure sub-pixel: Threshold for low frequency signals
0x52DA	CIP CTRL5A	0x00	RW	Bit[7:2]: Not used Bit[1:0]: man_int_noise[9:8] for short exposure sub-pixel Int_noise is input only in manual mode and is used as threshold in some filters
0x52DB	CIP CTRL5B	0x30	RW	Bit[7:0]: man_int_noise[7:0] for short exposure sub-pixel Int_noise is input only in manual mode and is used as threshold in some filters
0x52DC	CIP CTRL5C	0x00	RW	Bit[7:1]: Not used Bit[0]: man_inv_noise[8] for short exposure sub-pixel In_noise is input only in manual mode and is used as threshold in some filters

table 7-13 CIP control registers (sheet 7 of 7)

address	register name	default value	R/W	description
0x52DD	CIP CTRL5D	0x55	RW	Bit[7:0]: man_inv_noise[7:0] for short exposure sub-pixel In_noise is input only in manual mode and is used as threshold in some filters
0x52DE	CIP CTRL5E	0x08	RW	Bit[7:6]: Not used Bit[5:0]: man_sharpen_p[5:0] for short exposure sub-pixel Sharpen_p is input only in manual mode and is used for function of adaptive sharpen
0x52DF	CIP CTRL5F	0x08	RW	Bit[7]: Not used Bit[6:0]: man_sharpen_m[6:0] for short exposure sub-pixel Sharpen_m is input only in manual mode and is used for function of adaptive sharpen
0x52E0	CIP CTRL60	0x06	RW	Bit[7:0]: man_sharpen_tp[7:0] for short exposure sub-pixel Sharpen_tp is input only in manual mode and is used for function of adaptive sharpen
0x52E1	CIP CTRL61	0x08	RW	Bit[7:0]: man_sharpen_tm[7:0] for short exposure sub-pixel: Sharpen_tm is input only in manual mode and is used for function of adaptive sharpen

7.14 CMX control [0xC318 - 0xC347]

table 7-14 CMX control registers (sheet 1 of 7)

address	register name	default value	R/W	description
0xC318	COLOR_MATRIX_L_1_1	–	RW	Bit[7:0]: Long color matrix 1[15:8] This register value must be initialized by user and must not be removed from start up sequence. Default value is random.
0xC319	COLOR_MATRIX_L_1_2	–	RW	Bit[7:0]: Long color matrix 1[7:0] This register value must be initialized by user and must not be removed from start up sequence. Default value is random.

table 7-14 CMX control registers (sheet 2 of 7)

address	register name	default value	R/W	description
0xC31A	COLOR_MATRIX_L_2_1	–	RW	Bit[7:0]: Long color matrix 2[15:8] This register value must be initialized by user and must not be removed from start up sequence. Default value is random.
0xC31B	COLOR_MATRIX_L_2_2	–	RW	Bit[7:0]: Long color matrix 2[7:0] This register value must be initialized by user and must not be removed from start up sequence. Default value is random.
0xC31C	COLOR_MATRIX_L_3_1	–	RW	Bit[7:0]: Long color matrix 3[15:8] This register value must be initialized by user and must not be removed from start up sequence. Default value is random.
0xC31D	COLOR_MATRIX_L_3_2	–	RW	Bit[7:0]: Long color matrix 3[7:0] This register value must be initialized by user and must not be removed from start up sequence. Default value is random.
0xC31E	COLOR_MATRIX_L_4_1	–	RW	Bit[7:0]: Long color matrix 4[15:8] This register value must be initialized by user and must not be removed from start up sequence. Default value is random.
0xC31F	COLOR_MATRIX_L_4_2	–	RW	Bit[7:0]: Long color matrix 4[7:0] This register value must be initialized by user and must not be removed from start up sequence. Default value is random.
0xC320	COLOR_MATRIX_L_5_1	–	RW	Bit[7:0]: Long color matrix 5[15:8] This register value must be initialized by user and must not be removed from start up sequence. Default value is random.
0xC321	COLOR_MATRIX_L_5_2	–	RW	Bit[7:0]: Long color matrix 5[7:0] This register value must be initialized by user and must not be removed from start up sequence. Default value is random.
0xC322	COLOR_MATRIX_L_6_1	–	RW	Bit[7:0]: Long color matrix 6[15:8] This register value must be initialized by user and must not be removed from start up sequence. Default value is random.

table 7-14 CMX control registers (sheet 3 of 7)

address	register name	default value	R/W	description
0xC323	COLOR_MATRIX_L_6_2	–	RW	Bit[7:0]: Long color matrix 6[7:0] This register value must be initialized by user and must not be removed from start up sequence. Default value is random.
0xC324	COLOR_MATRIX_L_7_1	–	RW	Bit[7:0]: Long color matrix 7[15:8] This register value must be initialized by user and must not be removed from start up sequence. Default value is random.
0xC325	COLOR_MATRIX_L_7_2	–	RW	Bit[7:0]: Long color matrix 7[7:0] This register value must be initialized by user and must not be removed from start up sequence. Default value is random.
0xC326	COLOR_MATRIX_L_8_1	–	RW	Bit[7:0]: Long color matrix 8[15:8] This register value must be initialized by user and must not be removed from start up sequence. Default value is random.
0xC327	COLOR_MATRIX_L_8_2	–	RW	Bit[7:0]: Long color matrix 8[7:0] This register value must be initialized by user and must not be removed from start up sequence. Default value is random.
0xC328	COLOR_MATRIX_L_9_1	–	RW	Bit[7:0]: Long color matrix 9[15:8] This register value must be initialized by user and must not be removed from start up sequence. Default value is random.
0xC329	COLOR_MATRIX_L_9_2	–	RW	Bit[7:0]: Long color matrix 9[7:0] This register value must be initialized by user and must not be removed from start up sequence. Default value is random.
0xC32A	COLOR_MATRIX_L_10_1	–	RW	Bit[7:0]: Long color matrix 10[15:8] This register value must be initialized by user and must not be removed from start up sequence. Default value is random.
0xC32B	COLOR_MATRIX_L_10_2	–	RW	Bit[7:0]: Long color matrix 10[7:0] This register value must be initialized by user and must not be removed from start up sequence. Default value is random.

table 7-14 CMX control registers (sheet 4 of 7)

address	register name	default value	R/W	description
0xC32C	COLOR_MATRIX_L_11_1	–	RW	Bit[7:0]: Long color matrix 11[15:8] This register value must be initialized by user and must not be removed from start up sequence. Default value is random.
0xC32D	COLOR_MATRIX_L_11_2	–	RW	Bit[7:0]: Long color matrix 11[7:0] This register value must be initialized by user and must not be removed from start up sequence. Default value is random.
0xC32E	COLOR_MATRIX_L_12_1	–	RW	Bit[7:0]: Long color matrix 12[15:8] This register value must be initialized by user and must not be removed from start up sequence. Default value is random.
0xC32F	COLOR_MATRIX_L_12_2	–	RW	Bit[7:0]: Long color matrix 12[7:0] This register value must be initialized by user and must not be removed from start up sequence. Default value is random.
0xC330	COLOR_MATRIX_S_1_1	–	RW	Bit[7:0]: Short color matrix 1[15:8] This register value must be initialized by user and must not be removed from start up sequence. Default value is random.
0xC331	COLOR_MATRIX_S_1_2	–	RW	Bit[7:0]: Short color matrix 1[7:0] This register value must be initialized by user and must not be removed from start up sequence. Default value is random.
0xC332	COLOR_MATRIX_S_2_1	–	RW	Bit[7:0]: Short color matrix 2[15:8] This register value must be initialized by user and must not be removed from start up sequence. Default value is random.
0xC333	COLOR_MATRIX_S_2_2	–	RW	Bit[7:0]: Short color matrix 2[7:0] This register value must be initialized by user and must not be removed from start up sequence. Default value is random.
0xC334	COLOR_MATRIX_S_3_1	–	RW	Bit[7:0]: Short color matrix 3[15:8] This register value must be initialized by user and must not be removed from start up sequence. Default value is random.

table 7-14 CMX control registers (sheet 5 of 7)

address	register name	default value	R/W	description
0xC335	COLOR_MATRIX_S_3_2	–	RW	Bit[7:0]: Short color matrix 3[7:0] This register value must be initialized by user and must not be removed from start up sequence. Default value is random.
0xC336	COLOR_MATRIX_S_4_1	–	RW	Bit[7:0]: Short color matrix 4[15:8] This register value must be initialized by user and must not be removed from start up sequence. Default value is random.
0xC337	COLOR_MATRIX_S_4_2	–	RW	Bit[7:0]: Short color matrix 4[7:0] This register value must be initialized by user and must not be removed from start up sequence. Default value is random.
0xC338	COLOR_MATRIX_S_5_1	–	RW	Bit[7:0]: Short color matrix 5[15:8] This register value must be initialized by user and must not be removed from start up sequence. Default value is random.
0xC339	COLOR_MATRIX_S_5_2	–	RW	Bit[7:0]: Short color matrix 5[7:0] This register value must be initialized by user and must not be removed from start up sequence. Default value is random.
0xC33A	COLOR_MATRIX_S_6_1	–	RW	Bit[7:0]: Short color matrix 6[15:8] This register value must be initialized by user and must not be removed from start up sequence. Default value is random.
0xC33B	COLOR_MATRIX_S_6_2	–	RW	Bit[7:0]: Short color matrix 6[7:0] This register value must be initialized by user and must not be removed from start up sequence. Default value is random.
0xC33C	COLOR_MATRIX_S_7_1	–	RW	Bit[7:0]: Short color matrix 7[15:8] This register value must be initialized by user and must not be removed from start up sequence. Default value is random.
0xC33D	COLOR_MATRIX_S_7_2	–	RW	Bit[7:0]: Short color matrix 7[7:0] This register value must be initialized by user and must not be removed from start up sequence. Default value is random.

table 7-14 CMX control registers (sheet 6 of 7)

address	register name	default value	R/W	description
0xC33E	COLOR_MATRIX_S_8_1	–	RW	Bit[7:0]: Short color matrix 8[15:8] This register value must be initialized by user and must not be removed from start up sequence. Default value is random.
0xC33F	COLOR_MATRIX_S_8_2	–	RW	Bit[7:0]: Short color matrix 8[7:0] This register value must be initialized by user and must not be removed from start up sequence. Default value is random.
0xC340	COLOR_MATRIX_S_9_1	–	RW	Bit[7:0]: Short color matrix 9[15:8] This register value must be initialized by user and must not be removed from start up sequence. Default value is random.
0xC341	COLOR_MATRIX_S_9_2	–	RW	Bit[7:0]: Short color matrix 9[7:0] This register value must be initialized by user and must not be removed from start up sequence. Default value is random.
0xC342	COLOR_MATRIX_S_10_1	–	RW	Bit[7:0]: Short color matrix 10[15:8] This register value must be initialized by user and must not be removed from start up sequence. Default value is random.
0xC343	COLOR_MATRIX_S_10_2	–	RW	Bit[7:0]: Short color matrix 10[7:0] This register value must be initialized by user and must not be removed from start up sequence. Default value is random.
0xC344	COLOR_MATRIX_S_11_1	–	RW	Bit[7:0]: Short color matrix 11[15:8] This register value must be initialized by user and must not be removed from start up sequence. Default value is random.
0xC345	COLOR_MATRIX_S_11_2	–	RW	Bit[7:0]: Short color matrix 11[7:0] This register value must be initialized by user and must not be removed from start up sequence. Default value is random.
0xC346	COLOR_MATRIX_S_12_1	–	RW	Bit[7:0]: Short color matrix 12[15:8] This register value must be initialized by user and must not be removed from start up sequence. Default value is random.

table 7-14 CMX control registers (sheet 7 of 7)

address	register name	default value	R/W	description
				Bit[7:0]: Short color matrix 12[7:0]
0xC347	COLOR_MATRIX_S_12_2	–	RW	This register value must be initialized by user and must not be removed from start up sequence. Default value is random.

7.15 low level filter (LLF) control [0x5380 - 0x538A]

Changing these register values is not recommended.

table 7-15 LLF control registers

address	register name	default value	R/W	description
0x5380	LLF RW00	0x10	RW	Bit[7:5]: Not used Bit[4:0]: Step
0x5381	LLF RW01	0x02	RW	Bit[7:2]: Not used Bit[1:0]: max_low_level[9:8]
0x5382	LLF RW02	0x00	RW	Bit[7:0]: max_low_level[7:0]
0x5383	LLF RW03	0x04	RW	Bit[7:6]: Not used Bit[5:0]: ps_thres[13:8]
0x5384	LLF RO04	0x00	RW	Bit[7:0]: ps_thres[7:0]
0x5385	LLF RO05	–	R	Bit[7:5]: Not used Bit[4:0]: low_pre_sum[20:16]
0x5386	LLF RO06	–	R	Bit[7:0]: low_pre_sum[15:8]
0x5387	LLF RO07	–	R	Bit[7:0]: low_pre_sum[7:0]
0x5388	LLF RO08	–	R	Bit[7:5]: Not used Bit[4:0]: low_next_sum[20:16]
0x5389	LLF RO09	–	R	Bit[7:0]: low_next_sum[15:8]
0x538A	LLF RO10	–	R	Bit[7:0]: low_next_sum[7:0]

7.16 combine [0x5400 - 0x542D, 0xC30C - 0xC4CB, 0x5A08 - 0x5A97, 0x5C18 - 0x5C6F]

table 7-16 combine control registers (sheet 1 of 10)

address	register name	default value	R/W	description
0x5400	COMB CTRL0	0x0F	RW	Bit[7:4]: Not used Bit[3]: Dark boost enable 0: Dark boost disable 1: Dark boost enable Bit[2]: combine_uv_weight enable 0: Combine without UV weight 1: Combine with UV weight Bit[1]: color_diff_compensate enable 0: Compensate disable 1: Compensate enable Bit[0]: Compensate error enable 0: Compensate error disable 1: Compensate error enable
0x5401	COMB CTRL1	0x05	RW	Bit[7:4]: Not used Bit[3:0]: comb_thre_s0 Threshold1 of short channel
0x5402	COMB CTRL2	0x08	RW	Bit[7:4]: Not used Bit[3:0]: comb_thre_s1 Threshold2 of short channel
0x5403	COMB CTRL3	0x0A	RW	Bit[7:4]: Not used Bit[3:0]: comb_thre_s2 Threshold3 of short channel
0x5404	COMB CTRL4	0x09	RW	Bit[7:4]: Not used Bit[3:0]: comb_thre_l0 Threshold1 of long channel
0x5405	COMB CTRL5	0x0A	RW	Bit[7:4]: Not used Bit[3:0]: comb_thre_l1 Threshold2 of long channel
0x5406	COMB CTRL6	0x0A	RW	Bit[7:4]: Not used Bit[3:0]: comb_thre_l2 Threshold3 of long channel
0x5407	COMB CTRL7	0x05	RW	Bit[7:4]: Not used Bit[3:0]: comb_uv_thre_s0 UV threshold1 of short channel
0x5408	COMB CTRL8	0x08	RW	Bit[7:4]: Not used Bit[3:0]: comb_uv_thre_s1 UV threshold2 of short channel

table 7-16 combine control registers (sheet 2 of 10)

address	register name	default value	R/W	description
0x5409	COMB CTRL9	0x0A	RW	Bit[7:4]: Not used Bit[3:0]: comb_uv_thre_s2 UV threshold3 of short channel
0x540A	COMB CTRL10	0x09	RW	Bit[7:4]: Not used Bit[3:0]: comb_uv_thre_l0 UV threshold1 of long channel
0x540B	COMB CTRL11	0x0A	RW	Bit[7:4]: Not used Bit[3:0]: comb_uv_thre_l1 UV threshold2 of long channel
0x540C	COMB CTRL12	0x0A	RW	Bit[7:4]: Not used Bit[3:0]: comb_uv_thre_l2 UV threshold3 of long channel
0x540D	COMB CTRL13	0x80	RW	Bit[7:0]: comb_weight00
0x540E	COMB CTRL14	0x80	RW	Bit[7:0]: comb_weight01
0x540F	COMB CTRL15	0x60	RW	Bit[7:0]: comb_weight02
0x5410	COMB CTRL16	0x40	RW	Bit[7:0]: comb_weight03
0x5411	COMB CTRL17	0x80	RW	Bit[7:0]: comb_weight10
0x5412	COMB CTRL18	0x80	RW	Bit[7:0]: comb_weight11
0x5413	COMB CTRL19	0x20	RW	Bit[7:0]: comb_weight12
0x5414	COMB CTRL20	0x10	RW	Bit[7:0]: comb_weight13
0x5415	COMB CTRL21	0x80	RW	Bit[7:0]: comb_weight20
0x5416	COMB CTRL22	0x80	RW	Bit[7:0]: comb_weight21
0x5417	COMB CTRL23	0x00	RW	Bit[7:0]: comb_weight22
0x5418	COMB CTRL24	0x00	RW	Bit[7:0]: comb_weight23
0x5419	COMB CTRL25	0x80	RW	Bit[7:0]: comb_weight30
0x541A	COMB CTRL26	0x80	RW	Bit[7:0]: comb_weight31
0x541B	COMB CTRL27	0x00	RW	Bit[7:0]: comb_weight32
0x541C	COMB CTRL28	0x00	RW	Bit[7:0]: comb_weight33
0x541D	COMB CTRL29	0x80	RW	Bit[7:0]: comb_uv_weight00
0x541E	COMB CTRL30	0x80	RW	Bit[7:0]: comb_uv_weight01
0x541F	COMB CTRL31	0x80	RW	Bit[7:0]: comb_uv_weight02
0x5420	COMB CTRL32	0x80	RW	Bit[7:0]: comb_uv_weight03

table 7-16 combine control registers (sheet 3 of 10)

address	register name	default value	R/W	description
0x5421	COMB_CTRL33	0x80	RW	Bit[7:0]: comb_uv_weight10
0x5422	COMB_CTRL34	0x80	RW	Bit[7:0]: comb_uv_weight11
0x5423	COMB_CTRL35	0x60	RW	Bit[7:0]: comb_uv_weight12
0x5424	COMB_CTRL36	0x40	RW	Bit[7:0]: comb_uv_weight13
0x5425	COMB_CTRL37	0x80	RW	Bit[7:0]: comb_uv_weight20
0x5426	COMB_CTRL38	0x80	RW	Bit[7:0]: comb_uv_weight21
0x5427	COMB_CTRL39	0x00	RW	Bit[7:0]: comb_uv_weight22
0x5428	COMB_CTRL40	0x00	RW	Bit[7:0]: comb_uv_weight23
0x5429	COMB_CTRL41	0x80	RW	Bit[7:0]: comb_uv_weight30
0x542A	COMB_CTRL42	0x80	RW	Bit[7:0]: comb_uv_weight31
0x542B	COMB_CTRL43	0x00	RW	Bit[7:0]: comb_uv_weight32
0x542C	COMB_CTRL44	0x00	RW	Bit[7:0]: comb_uv_weight33
0x542D	COMB_CTRL45	0x3C	RW	Debug Mode for Combine Bit[7:6]: Not used Bit[5:2]: Fixed value for read only register Bit[1]: Debug mode 2 (EOF to VSYNC fixed value, other than zero) Bit[0]: Debug mode 1 (always fixed value)
0xC30C	COMB_CTRL_PT1	–	RW	Bit[7:0]: Combine control point number 1 This register value must be initialized by user and must not be removed from start up sequence. Default value is random.
0xC30D	COMB_CTRL_PT2	–	RW	Bit[7:0]: Combine control point number 2 This register value must be initialized by user and must not be removed from start up sequence. Default value is random.
0xC30E	COMB_CTRL_PT3	–	RW	Bit[7:0]: Combine control point number 3 This register value must be initialized by user and must not be removed from start up sequence. Default value is random.

table 7-16 combine control registers (sheet 4 of 10)

address	register name	default value	R/W	description
				Bit[7:0]: Combine control point number 4
0xC30F	COMB_CTRL_PT4	–	RW	This register value must be initialized by user and must not be removed from start up sequence. Default value is random.
				Bit[7:1]: Not used Bit[0]: Cut black level 0: Disable 1: Enable
0xC4B4	CUT_BL_EN	–	RW	When register value is 0x00, it means function is disabled; all other values mean function is enabled. This register value must be initialized by user and must not be removed from start up sequence. Default value is random.
				Bit[7:1]: Not used Bit[0]: Dark boost auto switch 0: Disable 1: Enable
0xC4B5	DARKBOOST_AUTO_EN	–	RW	When register value is 0x00, it means function is disabled; all other values mean function is enabled. This register value must be initialized by user and must not be removed from start up sequence. Default value is random.
				Bit[7:1]: Not used Bit[0]: Auto low level 0: Disable 1: Enable
0xC4B6	AUTO_LOW_LEVEL_EN	–	RW	When register value is 0x00, it means function is disabled; all other values mean function is enabled. This register value must be initialized by user and must not be removed from start up sequence. Default value is random.
				Bit[7:0]: Max curve gain[15:8]
0xC4BC	MAX_CURVE_GAIN_1	–	RW	When register value is 0x00, it means function is disabled; all other values mean function is enabled. This register value must be initialized by user and must not be removed from start up sequence. Default value is random.
				Bit[7:0]: Max curve gain[7:0]
0xC4BD	MAX_CURVE_GAIN_2	–	RW	This register value will be automatically initialized by sensor after powering up. Default value is random.

table 7-16 combine control registers (sheet 5 of 10)

address	register name	default value	R/W	description
				Bit[7:0]: Manual gamma[15:8]
0xC4BE	MANUAL_GAMMA_1	–	RW	This register value must be initialized by user and must not be removed from start up sequence. Default value is random.
				Bit[7:0]: Manual gamma[7:0]
0xC4BF	MANUAL_GAMMA_2	–	RW	This register value must be initialized by user and must not be removed from start up sequence. Default value is random.
				Bit[7:0]: Dark boost gain threshold 1[15:8]
0xC4C0	DB_GAIN_THRE_11	–	RW	This register value will be automatically initialized by sensor after powering up. Default value is random.
				Bit[7:0]: Dark boost gain threshold 1[7:0]
0xC4C1	DB_GAIN_THRE_12	–	RW	This register value will be automatically initialized by sensor after powering up. Default value is random.
				Bit[7:0]: Dark boost gain threshold 2[15:8]
0xC4C2	DB_GAIN_THRE_21	–	RW	This register value will be automatically initialized by sensor after powering up. Default value is random.
				Bit[7:0]: Dark boost gain threshold 2[7:0]
0xC4C3	DB_GAIN_THRE_22	–	RW	This register value will be automatically initialized by sensor after powering up. Default value is random.
				Dark Boost Amount
0xC4C4	DB_AMT	–	RW	This register value will be automatically initialized by sensor after powering up. Default value is random.
				Min Dark Boost Amount
0xC4C5	DB_AMT_MIN	–	RW	This register value will be automatically initialized by sensor after powering up. Default value is random.
				Max Dark Boost Amount
0xC4C6	DB_AMT_MAX	–	RW	This register value will be automatically initialized by sensor after powering up. Default value is random.
				Combine Error Compensation Step
0xC4C7	ERROR_STEP	–	RW	This register value will be automatically initialized by sensor after powering up. Default value is random.

table 7-16 combine control registers (sheet 6 of 10)

address	register name	default value	R/W	description
0xC4C8	DB_MAX_GAMMA_1	–	RW	Bit[7:0]: Max dark boost gamma[15:8] This register value must be initialized by user and must not be removed from start up sequence. Default value is random.
0xC4C9	DB_MAX_GAMMA_2	–	RW	Bit[7:0]: Max dark boost gamma[7:0] This register value must be initialized by user and must not be removed from start up sequence. Default value is random.
0xC4CA	DARK_TONE_WIDTH_1	–	RW	Bit[7:0]: Dark boost tone width[15:8] This register value must be initialized by user and must not be removed from start up sequence. Default value is random.
0xC4CB	DEBUG MODE	–	–	Debug Mode
0x5A08~ 0x5A97	COMB_RO	–	R	Debug Information for Combine Control Registers
0x5C18	COMB_RO01	–	R	Bit[7:3]: Not used Bit[2:0]: pLocalGainBuf0[10:8]
0x5C19	COMB_RO02	–	R	Bit[7:0]: pLocalGainBuf0[7:0]
0x5C1A	COMB_RO03	–	R	Bit[7:3]: Not used Bit[2:0]: pLocalGainBuf1[10:8]
0x5C1B	COMB_RO04	–	R	Bit[7:0]: pLocalGainBuf1[7:0]
0x5C1C	COMB_RO05	–	R	Bit[7:3]: Not used Bit[2:0]: pLocalGainBuf2[10:8]
0x5C1D	COMB_RO06	–	R	Bit[7:0]: pLocalGainBuf2[7:0]
0x5C1E	COMB_RO07	–	R	Bit[7:3]: Not used Bit[2:0]: pLocalGainBuf3[10:8]
0x5C1F	COMB_RO08	–	R	Bit[7:0]: pLocalGainBuf3[7:0]
0x5C20	COMB_RO09	–	R	Bit[7:3]: Not used Bit[2:0]: pLocalGainBuf4[10:8]
0x5C21	COMB_RO10	–	R	Bit[7:0]: pLocalGainBuf4[7:0]
0x5C22	COMB_RO11	–	R	Bit[7:3]: Not used Bit[2:0]: pLocalGainBuf5[10:8]
0x5C23	COMB_RO12	–	R	Bit[7:0]: pLocalGainBuf5[7:0]
0x5C24	COMB_RO13	–	R	Bit[7:3]: Not used Bit[2:0]: pLocalGainBuf6[10:8]

table 7-16 combine control registers (sheet 7 of 10)

address	register name	default value	R/W	description
0x5C25	COMB_RO14	–	R	Bit[7:0]: pLocalGainBuf6[7:0]
0x5C26	COMB_RO15	–	R	Bit[7:3]: Not used Bit[2:0]: pLocalGainBuf7[10:8]
0x5C27	COMB_RO16	–	R	Bit[7:0]: pLocalGainBuf7[7:0]
0x5C28	COMB_RO17	–	R	Bit[7:3]: Not used Bit[2:0]: pLocalGainBuf8[10:8]
0x5C29	COMB_RO18	–	R	Bit[7:0]: pLocalGainBuf8[7:0]
0x5C2A	COMB_RO19	–	R	Bit[7:3]: Not used Bit[2:0]: pLocalGainBuf9[10:8]
0x5C2B	COMB_RO20	–	R	Bit[7:0]: pLocalGainBuf9[7:0]
0x5C2C	COMB_RO21	–	R	Bit[7:3]: Not used Bit[2:0]: pLocalGainBuf10[10:8]
0x5C2D	COMB_RO22	–	R	Bit[7:0]: pLocalGainBuf10[7:0]
0x5C2E	COMB_RO23	–	R	Bit[7:3]: Not used Bit[2:0]: pLocalGainBuf11[10:8]
0x5C2F	COMB_RO24	–	R	Bit[7:0]: pLocalGainBuf11[7:0]
0x5C30	COMB_RO25	–	R	Bit[7:3]: Not used Bit[2:0]: pLocalGainBuf12[10:8]
0x5C31	COMB_RO26	–	R	Bit[7:0]: pLocalGainBuf12[7:0]
0x5C32	COMB_RO27	–	R	Bit[7:3]: Not used Bit[2:0]: pLocalGainBuf13[10:8]
0x5C33	COMB_RO28	–	R	Bit[7:0]: pLocalGainBuf13[7:0]
0x5C34	COMB_RO29	–	R	Bit[7:3]: Not used Bit[2:0]: pLocalGainBuf14[10:8]
0x5C35	COMB_RO30	–	R	Bit[7:0]: pLocalGainBuf14[7:0]
0x5C36	COMB_RO31	–	R	Bit[7:3]: Not used Bit[2:0]: pLocalGainBuf15[10:8]
0x5C37	COMB_RO32	–	R	Bit[7:0]: pLocalGainBuf15[7:0]
0x5C38	COMB_RO33	–	R	Bit[7:3]: Not used Bit[2:0]: pLocalGainBuf16[10:8]
0x5C39	COMB_RO34	–	R	Bit[7:0]: pLocalGainBuf16[7:0]
0x5C3A	COMB_RO35	–	R	Bit[7:3]: Not used Bit[2:0]: pLocalGainBuf17[10:8]
0x5C3B	COMB_RO36	–	R	Bit[7:0]: pLocalGainBuf17[7:0]

table 7-16 combine control registers (sheet 8 of 10)

address	register name	default value	R/W	description
0x5C3C	COMB_RO37	–	R	Bit[7:3]: Not used Bit[2:0]: pLocalGainBuf18[10:8]
0x5C3D	COMB_RO38	–	R	Bit[7:0]: pLocalGainBuf18[7:0]
0x5C3E	COMB_RO39	–	R	Bit[7:3]: Not used Bit[2:0]: pLocalGainBuf19[10:8]
0x5C3F	COMB_RO40	–	R	Bit[7:0]: pLocalGainBuf19[7:0]
0x5C40	COMB_RO41	–	R	Bit[7:3]: Not used Bit[2:0]: pLocalGainBuf20[10:8]
0x5C41	COMB_RO42	–	R	Bit[7:0]: pLocalGainBuf20[7:0]
0x5C42	COMB_RO43	–	R	Bit[7:3]: Not used Bit[2:0]: pLocalGainBuf21[10:8]
0x5C43	COMB_RO44	–	R	Bit[7:0]: pLocalGainBuf21[7:0]
0x5C44	COMB_RO45	–	R	Bit[7:3]: Not used Bit[2:0]: pLocalGainBuf22[10:8]
0x5C45	COMB_RO46	–	R	Bit[7:0]: pLocalGainBuf22[7:0]
0x5C46	COMB_RO47	–	R	Bit[7:3]: Not used Bit[2:0]: pLocalGainBuf23[10:8]
0x5C47	COMB_RO48	–	R	Bit[7:0]: pLocalGainBuf23[7:0]
0x5C48	COMB_RO49	–	R	Bit[7:3]: Not used Bit[2:0]: pLocalGainBuf24[10:8]
0x5C49	COMB_RO50	–	R	Bit[7:0]: pLocalGainBuf24[7:0]
0x5C4A	COMB_RO51	–	R	Bit[7:6]: Not used Bit[5:0]: AWBLogRatio_R[13:8] Two's complement
0x5C4B	COMB_RO52	–	R	Bit[7:0]: AWBLogRatio_R[7:0] Two's complement
0x5C4C	COMB_RO53	–	R	Bit[7:6]: Not used Bit[5:0]: AWBLogRatio_G[13:8] Two's complement
0x5C4D	COMB_RO54	–	R	Bit[7:0]: AWBLogRatio_G[7:0] Two's complement
0x5C4E	COMB_RO55	–	R	Bit[7:6]: Not used Bit[5:0]: AWBLogRatio_B[13:8] Two's complement
0x5C4F	COMB_RO56	–	R	Bit[7:0]: AWBLogRatio_B[7:0] Two's complement

table 7-16 combine control registers (sheet 9 of 10)

address	register name	default value	R/W	description
0x5C50	NOT USED	–	–	Not Used
0x5C51	COMB_RO58	–	R	Bit[7:1]: Not used Bit[0]: LogBlackX[16] Two's complement
0x5C52	COMB_RO59	–	R	Bit[7:0]: LogBlackX[15:8] Two's complement
0x5C53	COMB_RO60	–	R	Bit[7:0]: LogBlackX[7:0] Two's complement
0x5C54	NOT USED	–	–	Not Used
0x5C55	COMB_RO62	–	R	Bit[7:1]: Not used Bit[0]: LogBlackY[16] Two's complement
0x5C56	COMB_RO63	–	R	Bit[7:0]: LogBlackY[15:8] Two's complement
0x5C57	COMB_RO64	–	R	Bit[7:0]: LogBlackY[7:0] Two's complement
0x5C58	COMB_RO65	–	R	Bit[7:0]: LogYMax[15:8]
0x5C59	COMB_RO66	–	R	Bit[7:0]: LogYMax[7:0]
0x5C5A	COMB_RO67	–	R	Bit[7:0]: LogXMax[15:8]
0x5C5B	COMB_RO68	–	R	Bit[7:0]: LogXMax[7:0]
0x5C5C	COMB_RO69	–	R	Bit[7]: Not used Bit[6:0]: GlobalLogRatio[14:8]
0x5C5D	COMB_RO70	–	R	Bit[7:0]: GlobalLogRatio[7:0]
0x5C5E	COMB_RO71	–	R	Bit[7]: Not used Bit[6:0]: GlobalLogHDRGain[14:8]
0x5C5F	COMB_RO72	–	R	Bit[7:0]: GlobalLogHDRGain[7:0]
0x5C60	COMB_RO73	–	R	Bit[7:2]: Not used Bit[1:0]: GlobalLogHDRGamma[9:8]
0x5C61	COMB_RO74	–	R	Bit[7:0]: GlobalLogHDRGamma[7:0]
0x5C62	COMB_RO75	–	R	Bit[7:2]: Not used Bit[1:0]: nCutBlackLevel[9:8]
0x5C63	COMB_RO76	–	R	Bit[7:0]: nCutBlackLevel[7:0]
0x5C64	COMB_RO77	–	R	Bit[7:0]: nDarkBoostYThre1[15:8]
0x5C65	COMB_RO78	–	R	Bit[7:0]: nDarkBoostYThre1[7:0]

table 7-16 combine control registers (sheet 10 of 10)

address	register name	default value	R/W	description
0x5C66	COMB_RO79	–	R	Bit[7:0]: nDarkBoostYThre2[15:8]
0x5C67	COMB_RO80	–	R	Bit[7:0]: nDarkBoostYThre2[7:0]
0x5C68~ 0x5C69	NOT USED	–	–	Not Used
0x5C6A	COMB_RO83	–	R	Bit[7:0]: nLogE[15:8] Two's complement
0x5C6B	COMB_RO84	–	R	Bit[7:0]: nLogE[7:0] Two's complement
0x5C6C	COMB_RO85	–	–	Not Used
0x5C6D	COMB_RO86	–	R	Bit[7:2]: Not used Bit[1:0]: OutputRange[17:16]
0x5C6E	COMB_RO87	–	R	Bit[7:0]: OutputRange[15:8]
0x5C6F	COMB_RO88	–	R	Bit[7:0]: OutputRange[7:0]

7.17 normalize (NMLZ) control [0x5480 - 0x5A98, 0x5C71 - 0x5C78]

table 7-17 NMLZ control registers (sheet 1 of 2)

address	register name	default value	R/W	description
0x5480	NORM RW00	0x01	RW	Bit[7:6]: Not used Bit[5]: Chip debug Bit[4:0]: Step
0x5481	NORM RW01	0x10	RW	Bit[7]: Not used Bit[6:0]: max_low_level 16 ~ 127
0x5482	NORM RW02	0xF8	RW	Bit[7:0]: min_low_level -128 to -16, complementary code
0x5483	NORM RW03	0x04	RW	Bit[7]: Not used Bit[6:0]: ps_thres[14:8]
0x5484	NORM RW04	0x00	RW	Bit[7:0]: ps_thres[7:0]
0x5485~ 0x5A98	NORM RO	–	R	Debug Information for NMLZ Control
0x5C71	NML_RW02	–	R	Bit[7:6]: Not used Bit[5:0]: nNormalizeGain[21:16]

table 7-17 NMLZ control registers (sheet 2 of 2)

address	register name	default value	R/W	description
0x5C72	NML_RW03	–	R	Bit[7:0]: nNormalizeGain[15:8]
0x5C73	NML_RW04	–	R	Bit[7:0]: nNormalizeGain[7:0]
0x5C74	NOT USED	–	R	Not Used
0x5C75	NML_RW06	–	R	Bit[7:2]: Not used Bit[1:0]: nHDROffset[17:16]
0x5C76	NML_RW07	–	R	Bit[7:0]: nHDROffset[15:8]
0x5C77	NML_RW08	–	R	Bit[7:0]: nHDROffset[7:0]
0x5C78	NML_RW09	–	R	Bit[7:0]: RW_CurLowLevel[7:0] Signed complementary code

7.18 tone mapping (TMAP) [0x5500 - 0x5511, 0xC4E4 - 0xC4F9, 0x5A9C - 0x5CFB]

table 7-18 TMAP control registers (sheet 1 of 10)

address	register name	default value	R/W	description
0x5500	TOMP RW00	0x03	RW	Bit[7:3]: Not used Bit[2:0]: edge_thre 000: 16 001: 32 010: 64 011: 128 100: 256 101: 512
0x5501	TOMP RW01	0x3A	RW	Bit[7:6]: Not used Bit[5]: h_dark_en Bit[4]: uv_dark_en Bit[3:2]: h_dark_thre 00: 16 01: 32 10: 48 11: 64 Bit[1:0]: uv_dark_thre 00: 16 01: 32 10: 48 11: 64

table 7-18 TMAP control registers (sheet 2 of 10)

address	register name	default value	R/W	description
0x5502	TOMP RW02	0x00	RW	Bit[7:1]: Not used Bit[0]: Chip debug
0x5503	TOMP RW03	0x40	RW	Bit[7:0]: Chip debug
0x5504	TOMP RW04	0xC6	RW	Chip Debug
0x5505	TOMP RW05	0x00	RW	Bit[7:4]: Not used Bit[3:0]: Chip debug
0x5506	TOMP RW06	0x00	RW	Bit[7]: Not used Bit[6:0]: Chip debug
0x5507	TOMP RW07	0x40	RW	Bit[7:0]: Chip debug
0x5508	TOMP RW08	0x04	RW	Bit[7]: Not used Bit[6:0]: Chip debug
0x5509	TOMP RW09	0x00	RW	Bit[7:0]: Chip debug
0x550A	TOMP RW10	0x00	RW	Bit[7]: Not used Bit[6:0]: Debug mode
0x550B	TOMP RW11	0x00	RW	Bit[7:0]: Debug mode
0x550C	TOMP RW12	0x00	RW	Bit[7:0]: Debug mode
0x550D	TOMP RW13	0x00	RW	Bit[7:1]: Not used Bit[0]: dbg_sram_freeze
0x550E	TOMP RW14	0x00	RW	Bit[7:0]: dbg_addr
0x550F~ 0x5511	TOMP RO	–	R	Debug Information for TMAP Control
				Contrast Curve 1
0xC4E4	CONTRAST_CURVE_1	–	RW	This register value must be initialized by user and must not be removed from start up sequence. Default value is random.
				Contrast Curve 2
0xC4E5	CONTRAST_CURVE_2	–	RW	This register value must be initialized by user and must not be removed from start up sequence. Default value is random.
				Contrast Curve 3
0xC4E6	CONTRAST_CURVE_3	–	RW	This register value must be initialized by user and must not be removed from start up sequence. Default value is random.

table 7-18 TMAP control registers (sheet 3 of 10)

address	register name	default value	R/W	description
				Contrast Curve 4
0xC4E7	CONTRAST_CURVE_4	–	RW	This register value must be initialized by user and must not be removed from start up sequence. Default value is random.
				Contrast Curve 5
0xC4E8	CONTRAST_CURVE_5	–	RW	This register value must be initialized by user and must not be removed from start up sequence. Default value is random.
				Contrast Curve 6
0xC4E9	CONTRAST_CURVE_6	–	RW	This register value must be initialized by user and must not be removed from start up sequence. Default value is random.
				Contrast Curve 7
0xC4EA	CONTRAST_CURVE_7	–	RW	This register value must be initialized by user and must not be removed from start up sequence. Default value is random.
				Contrast Curve 8
0xC4EB	CONTRAST_CURVE_8	–	RW	This register value must be initialized by user and must not be removed from start up sequence. Default value is random.
				Contrast Curve 9
0xC4EC	CONTRAST_CURVE_9	–	RW	This register value must be initialized by user and must not be removed from start up sequence. Default value is random.
				Contrast Curve 10
0xC4ED	CONTRAST_CURVE_10	–	RW	This register value must be initialized by user and must not be removed from start up sequence. Default value is random.
				Contrast Curve 11
0xC4EE	CONTRAST_CURVE_11	–	RW	This register value must be initialized by user and must not be removed from start up sequence. Default value is random.
				Contrast Curve 12
0xC4EF	CONTRAST_CURVE_12	–	RW	This register value must be initialized by user and must not be removed from start up sequence. Default value is random.

table 7-18 TMAP control registers (sheet 4 of 10)

address	register name	default value	R/W	description
				Contrast Curve 13
0xC4F0	CONTRAST_CURVE_13	–	RW	This register value must be initialized by user and must not be removed from start up sequence. Default value is random.
				Contrast Curve 14
0xC4F1	CONTRAST_CURVE_14	–	RW	This register value must be initialized by user and must not be removed from start up sequence. Default value is random.
				Contrast Curve 15
0xC4F2	CONTRAST_CURVE_15	–	RW	This register value must be initialized by user and must not be removed from start up sequence. Default value is random.
				Curve Adjustment Step
0xC4F3	CURVE_STEP	–	RW	This register value must be initialized by user and must not be removed from start up sequence. Default value is random.
				Bit[7:0]: Curve min dynamic range[15:8]
0xC4F4	CURVE_MIN_DR_1	–	RW	This register value must be initialized by user and must not be removed from start up sequence. Default value is random.
				Bit[7:0]: Curve min dynamic range[7:0]
0xC4F5	CURVE_MIN_DR_2	–	RW	This register value must be initialized by user and must not be removed from start up sequence. Default value is random.
				Bit[7:0]: Curve max dynamic range[15:8]
0xC4F6	CURVE_MAX_DR_1	–	RW	This register value must be initialized by user and must not be removed from start up sequence. Default value is random.
				Bit[7:0]: Curve max dynamic range[7:0]
0xC4F7	CURVE_MAX_DR_2	–	RW	This register value must be initialized by user and must not be removed from start up sequence. Default value is random.
				Min Curve Alpha
0xC4F8	CURVE_MIN_ALPHA	–	RW	This register value must be initialized by user and must not be removed from start up sequence. Default value is random.

table 7-18 TMAP control registers (sheet 5 of 10)

address	register name	default value	R/W	description
				Max Curve Alpha
0xC4F9	CURVE_MAX_ALPHA	–	RW	This register value must be initialized by user and must not be removed from start up sequence. Default value is random.
0x5A9C~ 0x5AAD	TMP_R	–	R	Debug Information for TMAP Control
0x5C7D	TMP_RO02	–	R	Bit[7:2]: Not used Bit[1:0]: pCurveList0[17:16]
0x5C7E	TMP_RO03	–	R	Bit[7:0]: pCurveList0[15:8]
0x5C7F	TMP_RO04	–	R	Bit[7:0]: pCurveList0[7:0]
0x5C80	NOT USED	–	–	Not Used
0x5C81	TMP_RO06	–	R	Bit[7:2]: Not used Bit[1:0]: pCurveList1[17:16]
0x5C82	TMP_RO07	–	R	Bit[7:0]: pCurveList1[15:8]
0x5C83	TMP_RO08	–	R	Bit[7:0]: pCurveList1[7:0]
0x5C84	NOT USED	–	–	Not Used
0x5C85	TMP_RO10	–	R	Bit[7:2]: Not used Bit[1:0]: pCurveList2[17:16]
0x5C86	TMP_RO11	–	R	Bit[7:0]: pCurveList2[15:8]
0x5C87	TMP_RO12	–	R	Bit[7:0]: pCurveList2[7:0]
0x5C88	NOT USED	–	–	Not Used
0x5C89	TMP_RO14	–	R	Bit[7:2]: Not used Bit[1:0]: pCurveList3[17:16]
0x5C8A	TMP_RO15	–	R	Bit[7:0]: pCurveList3[15:8]
0x5C8B	TMP_RO16	–	R	Bit[7:0]: pCurveList3[7:0]
0x5C8C	NOT USED	–	–	Not Used
0x5C8D	TMP_RO18	–	R	Bit[7:2]: Not used Bit[1:0]: pCurveList4[17:16]
0x5C8E	TMP_RO19	–	R	Bit[7:0]: pCurveList4[15:8]
0x5C8F	TMP_RO20	–	R	Bit[7:0]: pCurveList4[7:0]
0x5C90	NOT USED	–	–	Not Used

table 7-18 TMAP control registers (sheet 6 of 10)

address	register name	default value	R/W	description
0x5C91	TMP_RO22	–	R	Bit[7:2]: Not used Bit[1:0]: pCurveList5[17:16]
0x5C92	TMP_RO23	–	R	Bit[7:0]: pCurveList5[15:8]
0x5C93	TMP_RO24	–	R	Bit[7:0]: pCurveList5[7:0]
0x5C94	NOT USED	–	–	Not Used
0x5C95	TMP_RO26	–	R	Bit[7:2]: Not used Bit[1:0]: pCurveList6[17:16]
0x5C96	TMP_RO27	–	R	Bit[7:0]: pCurveList6[15:8]
0x5C97	TMP_RO28	–	R	Bit[7:0]: pCurveList6[7:0]
0x5C98	NOT USED	–	–	Not Used
0x5C99	TMP_RO30	–	R	Bit[7:2]: Not used Bit[1:0]: pCurveList7[17:16]
0x5C9A	TMP_RO31	–	R	Bit[7:0]: pCurveList7[15:8]
0x5C9B	TMP_RO32	–	R	Bit[7:0]: pCurveList7[7:0]
0x5C9C	NOT USED	–	–	Not Used
0x5C9D	TMP_RO34	–	R	Bit[7:2]: Not used Bit[1:0]: pCurveList8[17:16]
0x5C9E	TMP_RO35	–	R	Bit[7:0]: pCurveList8[15:8]
0x5C9F	TMP_RO36	–	R	Bit[7:0]: pCurveList8[7:0]
0x5CA0	NOT USED	–	–	Not Used
0x5CA1	TMP_RO38	–	R	Bit[7:2]: Not used Bit[1:0]: pCurveList9[17:16]
0x5CA2	TMP_RO39	–	R	Bit[7:0]: pCurveList9[15:8]
0x5CA3	TMP_RO40	–	R	Bit[7:0]: pCurveList9[7:0]
0x5CA4	NOT USED	–	–	Not Used
0x5CA5	TMP_RO42	–	R	Bit[7:2]: Not used Bit[1:0]: pCurveList10[17:16]
0x5CA6	TMP_RO43	–	R	Bit[7:0]: pCurveList10[15:8]
0x5CA7	TMP_RO44	–	R	Bit[7:0]: pCurveList10[7:0]
0x5CA8	NOT USED	–	–	Not Used
0x5CA9	TMP_RO46	–	R	Bit[7:2]: Not used Bit[1:0]: pCurveList11[17:16]

table 7-18 TMAP control registers (sheet 7 of 10)

address	register name	default value	R/W	description
0x5CAA	TMP_RO47	–	R	Bit[7:0]: pCurveList11[15:8]
0x5CAB	TMP_RO48	–	R	Bit[7:0]: pCurveList11[7:0]
0x5CAC	NOT USED	–	–	Not Used
0x5CAD	TMP_RO50	–	R	Bit[7:2]: Not used Bit[1:0]: pCurveList12[17:16]
0x5CAE	TMP_RO51	–	R	Bit[7:0]: pCurveList12[15:8]
0x5CAF	TMP_RO52	–	R	Bit[7:0]: pCurveList12[7:0]
0x5CB0	NOT USED	–	–	Not Used
0x5CB1	TMP_RO54	–	R	Bit[7:2]: Not used Bit[1:0]: pCurveList13[17:16]
0x5CB2	TMP_RO55	–	R	Bit[7:0]: pCurveList13[15:8]
0x5CB3	TMP_RO56	–	R	Bit[7:0]: pCurveList13[7:0]
0x5CB4	NOT USED	–	–	Not Used
0x5CB5	TMP_RO58	–	R	Bit[7:2]: Not used Bit[1:0]: pCurveList14[17:16]
0x5CB6	TMP_RO59	–	R	Bit[7:0]: pCurveList14[15:8]
0x5CB7	TMP_RO60	–	R	Bit[7:0]: pCurveList14[7:0]
0x5CB8	NOT USED	–	–	Not Used
0x5CB9	TMP_RO62	–	R	Bit[7:2]: Not used Bit[1:0]: pCurveList15[17:16]
0x5CBA	TMP_RO63	–	R	Bit[7:0]: pCurveList15[15:8]
0x5CBB	TMP_RO64	–	R	Bit[7:0]: pCurveList15[7:0]
0x5CBC	TMP_RO65	–	R	Bit[7:2]: Not used Bit[1:0]: pCurveGainList0[9:8]
0x5CBD	TMP_RO66	–	R	Bit[7:0]: pCurveGainList0[7:0]
0x5CBE	TMP_RO67	–	R	Bit[7:2]: Not used Bit[1:0]: pCurveGainList1[9:8]
0x5CBF	TMP_RO68	–	R	Bit[7:0]: pCurveGainList1[7:0]
0x5CC0	TMP_RO69	–	R	Bit[7:2]: Not used Bit[1:0]: pCurveGainList2[9:8]
0x5CC1	TMP_RO70	–	R	Bit[7:0]: pCurveGainList2[7:0]

table 7-18 TMAP control registers (sheet 8 of 10)

address	register name	default value	R/W	description
0x5CC2	TMP_RO71	–	R	Bit[7:2]: Not used Bit[1:0]: pCurveGainList3[9:8]
0x5CC3	TMP_RO72	–	R	Bit[7:0]: pCurveGainList3[7:0]
0x5CC4	TMP_RO73	–	R	Bit[7:2]: Not used Bit[1:0]: pCurveGainList4[9:8]
0x5CC5	TMP_RO74	–	R	Bit[7:0]: pCurveGainList4[7:0]
0x5CC6	TMP_RO75	–	R	Bit[7:2]: Not used Bit[1:0]: pCurveGainList5[9:8]
0x5CC7	TMP_RO76	–	R	Bit[7:0]: pCurveGainList5[7:0]
0x5CC8	TMP_RO77	–	R	Bit[7:2]: Not used Bit[1:0]: pCurveGainList6[9:8]
0x5CC9	TMP_RO78	–	R	Bit[7:0]: pCurveGainList6[7:0]
0x5CCA	TMP_RO79	–	R	Bit[7:2]: Not used Bit[1:0]: pCurveGainList7[9:8]
0x5CCB	TMP_RO80	–	R	Bit[7:0]: pCurveGainList7[7:0]
0x5CCC	TMP_RO81	–	R	Bit[7:2]: Not used Bit[1:0]: pCurveGainList8[9:8]
0x5CCD	TMP_RO82	–	R	Bit[7:0]: pCurveGainList8[7:0]
0x5CCE	TMP_RO83	–	R	Bit[7:2]: Not used Bit[1:0]: pCurveGainList9[9:8]
0x5CCF	TMP_RO84	–	R	Bit[7:0]: pCurveGainList9[7:0]
0x5CD0	TMP_RO85	–	R	Bit[7:2]: Not used Bit[1:0]: pCurveGainList10[9:8]
0x5CD1	TMP_RO86	–	R	Bit[7:0]: pCurveGainList10[7:0]
0x5CD2	TMP_RO87	–	R	Bit[7:2]: Not used Bit[1:0]: pCurveGainList11[9:8]
0x5CD3	TMP_RO88	–	R	Bit[7:0]: pCurveGainList11[7:0]
0x5CD4	TMP_RO89	–	R	Bit[7:2]: Not used Bit[1:0]: pCurveGainList12[9:8]
0x5CD5	TMP_RO90	–	R	Bit[7:0]: pCurveGainList12[7:0]
0x5CD6	TMP_RO91	–	R	Bit[7:2]: Not used Bit[1:0]: pCurveGainList13[9:8]
0x5CD7	TMP_RO92	–	R	Bit[7:0]: pCurveGainList13[7:0]

table 7-18 TMAP control registers (sheet 9 of 10)

address	register name	default value	R/W	description
0x5CD8	TMP_RO93	–	R	Bit[7:2]: Not used Bit[1:0]: pCurveGainList14[9:8]
0x5CD9	TMP_RO94	–	R	Bit[7:0]: pCurveGainList14[7:0]
0x5CDA	TMP_RO95	–	R	Bit[7:2]: Not used Bit[1:0]: pCurveGainList15[9:8]
0x5CDB	TMP_RO96	–	R	Bit[7:0]: pCurveGainList15[7:0]
0x5CDC	TMP_RO97	–	R	Bit[7:0]: pCurveSegAList0[7:0]
0x5CDD	TMP_RO98	–	R	Bit[7:0]: pCurveSegAList1[7:0]
0x5CDE	TMP_RO99	–	R	Bit[7:0]: pCurveSegAList2[7:0]
0x5CDF	TMP_RO100	–	R	Bit[7:0]: pCurveSegAList3[7:0]
0x5CE0	TMP_RO101	–	R	Bit[7:0]: pCurveSegAList4[7:0]
0x5CE1	TMP_RO102	–	R	Bit[7:0]: pCurveSegAList5[7:0]
0x5CE2	TMP_RO103	–	R	Bit[7:0]: pCurveSegAList6[7:0]
0x5CE3	TMP_RO104	–	R	Bit[7:0]: pCurveSegAList7[7:0]
0x5CE4	TMP_RO105	–	R	Bit[7:0]: pCurveSegAList8[7:0]
0x5CE5	TMP_RO106	–	R	Bit[7:0]: pCurveSegAList9[7:0]
0x5CE6	TMP_RO107	–	R	Bit[7:0]: pCurveSegAList10[7:0]
0x5CE7	TMP_RO108	–	R	Bit[7:0]: pCurveSegAList11[7:0]
0x5CE8	TMP_RO109	–	R	Bit[7:0]: pCurveSegAList12[7:0]
0x5CE9	TMP_RO110	–	R	Bit[7:0]: pCurveSegAList13[7:0]
0x5CEA	TMP_RO111	–	R	Bit[7:0]: pCurveSegAList14[7:0]
0x5CEB	TMP_RO112	–	R	Bit[7:0]: pCurveSegAList15[7:0]
0x5CEC	TMP_RO113	–	R	Bit[7:5]: Not used Bit[4:0]: pCurveSegBList0[4:0]
0x5CED	TMP_RO114	–	R	Bit[7:5]: Not used Bit[4:0]: pCurveSegBList1[4:0]
0x5CEE	TMP_RO115	–	R	Bit[7:5]: Not used Bit[4:0]: pCurveSegBList2[4:0]
0x5CEF	TMP_RO116	–	R	Bit[7:5]: Not used Bit[4:0]: pCurveSegBList3[4:0]
0x5CF0	TMP_RO117	–	R	Bit[7:5]: Not used Bit[4:0]: pCurveSegBList4[4:0]

table 7-18 TMAP control registers (sheet 10 of 10)

address	register name	default value	R/W	description
0x5CF1	TMP_RO118	–	R	Bit[7:5]: Not used Bit[4:0]: pCurveSegBList5[4:0]
0x5CF2	TMP_RO119	–	R	Bit[7:5]: Not used Bit[4:0]: pCurveSegBList6[4:0]
0x5CF3	TMP_RO120	–	R	Bit[7:5]: Not used Bit[4:0]: pCurveSegBList7[4:0]
0x5CF4	TMP_RO121	–	R	Bit[7:5]: Not used Bit[4:0]: pCurveSegBList8[4:0]
0x5CF5	TMP_RO122	–	R	Bit[7:5]: Not used Bit[4:0]: pCurveSegBList9[4:0]
0x5CF6	TMP_RO123	–	R	Bit[7:5]: Not used Bit[4:0]: pCurveSegBList10[4:0]
0x5CF7	TMP_RO124	–	R	Bit[7:5]: Not used Bit[4:0]: pCurveSegBList11[4:0]
0x5CF8	TMP_RO125	–	R	Bit[7:5]: Not used Bit[4:0]: pCurveSegBList12[4:0]
0x5CF9	TMP_RO126	–	R	Bit[7:5]: Not used Bit[4:0]: pCurveSegBList13[4:0]
0x5CFA	TMP_RO127	–	R	Bit[7:5]: Not used Bit[4:0]: pCurveSegBList14[4:0]
0x5CFB	TMP_RO128	–	R	Bit[7:5]: Not used Bit[4:0]: pCurveSegBList15[4:0]

7.19 frame counter (FC) control [0x4200 - 0x4203]

table 7-19 FC control registers (sheet 1 of 2)

address	register name	default value	R/W	description
0x4200	FC_R0	0x00	RW	Bit[7:3]: Not used Bit[2]: fcnt_eof_sel Bit[1]: fcnt_mask_dis Bit[0]: fcnt_reset
0x4201	FC_R1	0x00	RW	Bit[7:4]: Not used Bit[3:0]: frame_on_number
0x4202	FC_R2	0x00	RW	Bit[7:4]: Not used Bit[3:0]: frame_off_number

table 7-19 FC control registers (sheet 2 of 2)

address	register name	default value	R/W	description
0x4203	FC_R3	0x00	RW	Bit[7]: Not used Bit[6]: rblue_mask_dis Bit[5]: data_mask_dis Bit[4]: valid_mask_dis Bit[3]: href_mask_dis Bit[2]: eof_mask_dis Bit[1]: sof_mask_dis Bit[0]: all_mask_dis

7.20 format control [0x4300, 0x4302 - 0x4309]

table 7-20 format control registers

address	register name	default value	R/W	description
0x4300	FORMAT_CTRL00	0xF8	RW	Bit[7:4]: Output format select 0x3: YUV mode 0xF: RAW mode Others: Not allowed Bit[3:0]: pix_order_ctrl 1000: YUYV 1001: YVYU 1010: UYVY 1011: VYUY
0x4302	FORMAT_YMAX	0x03	RW	Bit[7:2]: Not used Bit[1:0]: Ymax[9:8]
0x4303	FORMAT_YMAX	0xFF	RW	Bit[7:0]: Ymax[7:0]
0x4304	FORMAT_YMIN	0x00	RW	Bit[7:2]: Not used Bit[1:0]: Ymin[9:8]
0x4305	FORMAT_YMIN	0x00	RW	Bit[7:0]: Ymin[7:0]
0x4306	FORMAT_UMAX	0x03	RW	Bit[7:2]: Not used Bit[1:0]: Umax[9:8]
0x4307	FORMAT_UMAX	0xFF	RW	Bit[7:0]: Umax[7:0]
0x4308	FORMAT_UMIN	0x00	RW	Bit[7:2]: Not used Bit[1:0]: Umin[9:8]
0x4309	FORMAT_UMIN	0x00	RW	Bit[7:0]: Umin[7:0]

7.21 VFIFO control [0x4600 - 0x4603, 0x4605 - 0x4613, 0x4620 - 0x4639]

table 7-21 VFIFO control registers (sheet 1 of 3)

address	register name	default value	R/W	description
0x4600	VFIFO_AFIFO_SRAM_CTRL	0x04	RW	Bit[7:4]: Not used Bit[3]: r_fi_pt VFIFO bypass Bit[2]: r_16bitin 16-bit data into AFIFO Bit[1]: r_sram_pt Bit[0]: r_sram_nofrst
0x4601	DEBUG MODE	–	–	Debug Mode
0x4602	VFIFO_FIRST1_POSITION	0x00	RW	Bit[7:0]: r_first_pos_high
0x4603	VFIFO_FIRST1_POSITION	0x00	RW	Bit[7:0]: r_first_pos_low
0x4605	VFIFO_LLEN_FIRS1_SEL	0x08	RW	Bit[7:4]: Not used Bit[3]: r_8b_yuv422 0: 10-bit YUV422 mode 1: 8-bit YUV422 mode Bit[2]: Line length select 0: Auto mode 1: From registers 0x4606, 0x4607 Bit[1:0]: r_first_sel in readout module
0x4606	VFIFO_LINE_LENGTH_MAN	0x00	RW	Bit[7:0]: Manual set line length[15:8]
0x4607	VFIFO_LINE_LENGTH_MAN	0x00	RW	Bit[7:0]: Manual set line length[7:0]
0x4608	VFIFO_READ_START	0x00	RW	Bit[7:0]: Read start[15:8]
0x4609	VFIFO_READ_START	0x08	RW	Bit[7:0]: Read start[7:0]
0x460A	VFIFO_HSYNC_START_POSITION	0x00	RW	Bit[7:0]: r_hsync_st[15:8]
0x460B	VFIFO_HSYNC_START_POSITION	0xBF	RW	Bit[7:0]: r_hsync_st[7:0]
0x460C	VFIFO_HSYNC_CTRL	0x00	RW	Bit[7:4]: HSYNC header width Bit[3:0]: HSYNC trail width
0x460D	DEBUG MODE	–	–	Debug Mode

table 7-21 VFIFO control registers (sheet 2 of 3)

address	register name	default value	R/W	description
0x460E	VFIFO_EMBD_LINE_CTRL	0x08	RW	Bit[7:4]: Not used Bit[3]: r_sof_clr_ram default 1 Bit[2]: r_st_mod 0: PCLK cycles trigger (default) 1: Byte size trigger Bit[1]: Debug mode Bit[0]: r_embd_en Embedded line mode enable
0x460F	VFIFO_EMBD_LINE_NUM	0x01	RW	Bit[7:0]: Embedded line amount
0x4610	EMB_ST_PCNT_H	0x00	RW	High Byte of Embedded Line Pcnt Start Point
0x4611	EMB_ST_PCNT_L	0x01	RW	Low Byte of Embedded Line Pcnt Start Point
0x4612	EMB_ST_LCNT_H	0x00	RW	High Byte of Embedded Line Lcnt Start Point
0x4613	EMB_ST_LCNT_L	0x01	RW	Low Byte of Embedded Line Lcnt Start Point
0x4620	ROI_CTRL0	0x0E	RW	Bit[7]: r_roi_sync_byp Bit[6]: r_fr_comp ROI output 8-bit data Front comp 2-bit 0 or back Bit[5]: r_full_dat_mod Bit[4]: Not used Bit[3]: r_roi_en_3 Bit[2]: r_roi_en_2 Bit[1]: r_roi_en_1 Bit[0]: r_roi_func_e
0x4621	ROI_CTRL1	0x31	RW	Bit[7]: Not used Bit[6:4]: r_sc_fsz_delay Bit[3:0]: roi_sync_cod_stv Sync code start
0x4622	ROI_XOFFS_1	0x00	RW	Window 1 Xoffset High Byte
0x4623	ROI_XOFFS_1	0x00	RW	Window 1 Xoffset Low Byte
0x4624	ROI_YOFFS_1	0x00	RW	Window 1 Yoffset High Byte
0x4625	ROI_YOFFS_1	0x00	RW	Window 1 Yoffset Low Byte
0x4626	ROI_XOFFS_2	0x02	RW	Window 2 Xoffset High Byte
0x4627	ROI_XOFFS_2	0x4E	RW	Window 2 Xoffset Low Byte
0x4628	ROI_YOFFS_2	0x01	RW	Window 2 Yoffset High Byte
0x4629	ROI_YOFFS_2	0x5E	RW	Window 2 Yoffset Low Byte
0x462A	ROI_XOFFS_3	0x04	RW	Window 3 Xoffset High Byte

table 7-21 VFIFO control registers (sheet 3 of 3)

address	register name	default value	R/W	description
0x462B	ROI_XOFFS_3	0x9C	RW	Window 3 Xoffset Low Byte
0x462C	ROI_YOFFS_3	0x02	RW	Window 3 Yoffset High Byte
0x462D	ROI_YOFFS_3	0xBC	RW	Window 3 Yoffset Low Byte
0x462E	ROI_HSIZE1_H	0x00	RW	Bit[7:1]: Not used Bit[0]: Window 1 hsize[8]
0x462F	ROI_HSIZE1_L	0x64	RW	Bit[7:0]: Window 1 hsize[7:0]
0x4630	ROI_VSIZE1_H	0x00	RW	Bit[7:2]: Not used Bit[1:0]: roi_vsize1[9:8]
0x4631	ROI_VSIZE1_L	0x64	RW	Bit[7:0]: roi_vsize1[7:0]
0x4632	ROI_HSIZE2_H	0x00	RW	Bit[7:1]: Not used Bit[0]: roi_hsize2[8]
0x4633	ROI_HSIZE2_L	0x64	RW	Bit[7:0]: roi_hsize2[7:0]
0x4634	ROI_VSIZE2_H	0x00	RW	Bit[7:2]: Not used Bit[1:0]: roi_vsize2[9:8]
0x4635	ROI_VSIZE2_L	0x64	RW	Bit[7:0]: roi_vsize2[7:0]
0x4636	ROI_HSIZE3_H	0x00	RW	Bit[7:1]: Not used Bit[0]: roi_hsize3[8]
0x4637	ROI_HSIZE3_L	0x64	RW	Bit[7:0]: roi_hsize3[7:0]
0x4638	ROI_VSIZE3_H	0x00	RW	Bit[7:2]: Not used Bit[1:0]: roi_vsize3[9:8]
0x4639	ROI_VSIZE3_L	0x64	RW	Bit[7:0]: roi_vsize3[7:0]

7.22 digital video port (DVP) control [0x4700 - 0x470D]

table 7-22 DVP control registers (sheet 1 of 4)

address	register name	default value	R/W	description
0x4700	DVP_MOD_SEL	0x04	RW	Bit[7:4]: Not used Bit[3]: CCIR v select Bit[2]: CCIR f value Bit[1]: CCIR656 mode enable Bit[0]: HSYNC mode enable
0x4701	DVP_VSYNC_WIDTH	0x01	RW	VSYNC Length, Line Count

table 7-22 DVP control registers (sheet 2 of 4)

address	register name	default value	R/W	description
0x4702	DVP_HSYVSY_NEG_WIDTH	0x00	RW	VSYNC Length, Pixel Count High Byte
0x4703	DVP_HSYVSY_NEG_WIDTH	0x01	RW	VSYNC Length, Pixel Count Low Byte
0x4704	DVP_VSYNC_MODE	0x00	RW	Bit[7:4]: Not used Bit[3:2]: r_vsyncout_sel Bit[1]: r_vsync3_mod Bit[0]: r_vsync2_mod
0x4705	DVP_EOF_VSYNC_DELAY	0x00	RW	SOF/EOF Negative Edge to VSYNC Positive Edge High Byte
0x4706	DVP_EOF_VSYNC_DELAY	0x00	RW	SOF/EOF Negative Edge to VSYNC Positive Edge Middle Byte
0x4707	DVP_EOF_VSYNC_DELAY	0x00	RW	SOF/EOF Negative Edge to VSYNC Positive Edge Low Byte
0x4708	DVP_POL_CTRL	0x01	RW	Bit[7]: Debug mode Bit[6]: Not used Bit[5]: VSYNC gate clock enable Bit[4]: HREF gate clock enable Bit[3]: No first for FIFO Bit[2]: HREF polarity Bit[1]: VSYNC polarity Bit[0]: PCLK polarity / PCLK gate low enable

Renesas Confidential for
only Electronics

table 7-22 DVP control registers (sheet 3 of 4)

address	register name	default value	R/W	description
0x4709	DVP_MOTO_ORDER	0x00	RW	<p>Bit[7]: Debug control</p> <p>Bit[6:4]: Data bit swap</p> <p>000: Data[9:0] outputs through pin D[9:0]</p> <p>001: Data[0:9] outputs through pin D[9:0]</p> <p>010: {Data[2:9], Data[1:0]} outputs through pin D[9:0]</p> <p>011: {Data[7:0], Data[9:8]} outputs through pin D[9:0]</p> <p>100: {Data[9:8], Data[0:7]} outputs through pin D[9:0]</p> <p>101: {Data[9], Data[0:8]} outputs through pin D[9:0]</p> <p>110: {Data[1:9], Data[0]} outputs through pin D[9:0]</p> <p>111: {Data[8:0], Data[9]} outputs through pin D[9:0]</p> <p>Bit[3]: Walking one pattern option</p> <p>0: Normal working one pattern</p> <p>1: Repeat each data one time in walking one pattern. e.g., 8-bit pattern changes to 0x00 -> 0x00 -> 0x01 -> 0x01 -> 0x02 -> 0x02 -> 0x04 -> 0x04 -> 0x08 -> 0x08 -> 0x10 -> 0x10 -> 0x20 -> 0x20 -> 0x40 -> 0x40 -> 0x80 -> 0x80 -> 0xFF -> 0xFF</p> <p>Bit[2:1]: Walking one pattern selection</p> <p>00: Debug option</p> <p>01: 8-bit walking one pattern for 8 most significant pins: 0x00 -> 0x01 -> 0x02 -> 0x04 -> 0x08 -> 0x10 -> 0x20 -> 0x40 -> 0x80 -> 0xFF</p>

table 7-22 DVP control registers (sheet 4 of 4)

address	register name	default value	R/W	description
				10: 10-bit walking one pattern for 10 data pins 0x000 -> 0x001 -> 0x002 -> 0x004 -> 0x008 -> 0x010 -> 0x020 -> 0x040 -> 0x080 -> 0x100 -> 0x200 -> 0x3FF 11: Debug option Bit[0]: Walking one test pattern enable 0: Disable 1: Enable
0x470A	DVP_BYP_SEL	0x00	RW	Bypass Enable High Byte
0x470B	DVP_BYP_SEL	0x00	RW	Bypass Enable Low Byte
0x470C	DVP_BYPASS	0x00	RW	Bit[7:5]: Not used Bit[4]: Debug mode Bit[3:0]: bypass_sel
0x470D	DVP_ROI_HREF_SEL	0x00	RW	Bit[7:3]: Not used Bit[2:0]: ROI HREF output select 000: Combine HREF out via dvp_href_o 001: 1/2 sc HREF out via dvp_href_o 010: ROI window 1 out via dvp_href_o 011: ROI window 2 out via dvp_href_o 100: ROI window 3 out via dvp_href_o

7.23 temperature sensor [0x6700 - 0x6719, 0x3827, 0x6720 - 0x6721]

table 7-23 temperature sensor control (TPM) (sheet 1 of 2)

address	register name	default value	R/W	description
0x6700	TPM_CTRL0	0x01	RW	TPM_SLOPE0
0x6701	TPM_CTRL1	0xDE	RW	TPM_SLOPE1
0x6702	TPM_CTRL2	0xDE	RW	TPM_OFFSET0

table 7-23 temperature sensor control (TPM) (sheet 2 of 2)

address	register name	default value	R/W	description
0x6703	TPM_CTRL3	0xDE	RW	TPM_OFFSET1
0x6704	TPM_CTRL4	0xDE	RW	TPM_OFFSET2
0x6705	TPM_CTRL5	0xDE	RW	TPM_OFFSET3
0x6706	TPM_CTRL6	0x71	RW	Bit[7:4]: Chip debug Bit[3:0]: Module clock divider
0x6707	TPM_STALL	0x00	RW	Chip Debug
0x6708~ 0x670F	RSVD	-	-	Reserved
0x6710~ 0x6714	TPM_DB_NUM	-	R	Debug Information for TPM Control
0x6715	TPM_DEBUG	-	R	Debug Mode
0x6716	TPM_DB_NUM	-	R	Debug Information for TPM Control
0x6717	TPM_DEBUG	-	R	Debug Mode
0x6718	TPM_DB_NUM	-	R	Debug Information for TPM Control
0x6719	TPM_DEBUG	-	R	Debug Mode
0x3827	TEMPERATURE	-	R	If 0x3827 < 192, temperature = 0x3829 If 0x3827 ≥ 192, temperature = -(256-0x3827)
0x6720~ 0x6721	TPM_DB_NUM	-	R	Debug Information for TPM Control

7.24 embedded line control [0x6800 - 0x6807]

table 7-24 embedded line control (EMB) registers (sheet 1 of 2)

address	register name	default value	R/W	description
0x6800	EMB_LINE_EN	0x00	RW	Bit[7:1]: Not used Bit[0]: emb_line enable
0x6801	EMB_LINE_TAG	0xDA	RW	Bit[7:0]: emb_line tag[9:2]
0x6802	EMB_LINE_TAG	0x01	RW	Bit[7:2]: Not used Bit[1:0]: emb_line tag[1:0]
0x6803	EMB_LINE_SOF_CTRL	0x11	RW	Bit[7:4]: s2h_width Bit[3:0]: sof_width

table 7-24 embedded line control (EMB) registers (sheet 2 of 2)

address	register name	default value	R/W	description
0x6804	EMB_SIZE_MANU_EN	0x00	RW	Bit[7:1]: Not used Bit[0]: emb_size manual enable
0x6805	EMB_SIZE_MANU	0x04	RW	Bit[7:4]: Not used Bit[3:0]: emb_size[11:8]
0x6806	EMB_SIZE_MANU	0x00	RW	Bit[7:0]: emb_size[7:0]
0x6807	EMB_MASK_EN	0x01	RW	Bit[7:1]: Not used Bit[0]: emb_line mask enable

7.25 group writer [0x6F00, 0x6F04 ~ 0x6F1F]

table 7-25 group writer registers (sheet 1 of 2)

address	register name	default value	R/W	description
0x6F00	GROUP WRITER COMMAND	0x00	RW	Bit[7:6]: Operation code 00: Group record end 01: Group launch (only once) 10: Group launch (ABC mode) 11: Group record start In ABC mode, group0 is for frame A, group1 is for frame B and group2 is for frame C. Three groups launch periodically. Bit[5:4]: Group ID Bit[3:2]: Chip debug Bit[1:0]: Group write function enable, must be 2'b11
0x6F04	PARI_ADDR_MIN	0x00	RW	Debug Control
0x6F05	PARI_ADDR_MIN	0x06	RW	Debug Control
0x6F06	PARI_ADDR_MIN	0x00	RW	Group Write Command Register Address, Must Be 0x6F
0x6F07	PARI_ADDR_MIN	0x00	RW	Group Write Command Register Address, Must Be 0x00
0x6F08	PARI_ADDR_MAX	0x00	RW	Debug Control
0x6F09	PARI_ADDR_MAX	0x06	RW	Debug Control

table 7-25 group writer registers (sheet 2 of 2)

address	register name	default value	R/W	description
0x6F0A	PARI_ADDR_MAX	0x6D	RW	Group Write Command Register Address, Must Be 0x6F
0x6F0B	PARI_ADDR_MAX	0xFF	RW	Group Write Command Register Address, Must Be 0x00
0x6F0C~ 0x6F1F	PARI_MASTER_SEL	–	RW	Debug Control

7.26 macro-code [0xD000 - 0xDFFF]

table 7-26 macro-code registers

address	register name	default value	R/W	description
0xD000~ 0xDFFF	MACRO-CODE REGISTERS	–	–	Macro-code Registers Can not be deleted. Sensor functions are combined with such settings

Confidential for
Renesas Electronics
only

8 operating specifications

8.1 absolute maximum ratings

table 8-1 absolute maximum ratings

parameter		absolute maximum rating ^a
ambient storage temperature		-50°C to +125°C
supply voltage (with respect to ground)	V_{DD-A}	4.5V
	V_{DD-IO}	4.5V
electro-static discharge (ESD)	human body model	2000V
	machine model	200V
all input/output voltages (with respect to ground)		-0.3V to $V_{DD-IO} + 1V$
I/O current on any input or output pin		± 200 mA
peak solder temperature (10 second dwell time)		245°C

- a. exceeding the absolute maximum ratings shown above invalidates all AC and DC electrical specifications and may result in permanent damage to the device. Exposure to absolute maximum rated conditions for extended periods may affect device reliability.

8.2 functional temperature

table 8-2 functional temperature

parameter	range
operating temperature ^a	-40°C to +105°C sensor ambient temperature

- a. sensor functions in the operating range; however, some image quality changes may be noticed at the temperature extremes

8.3 DC characteristics

table 8-3 DC characteristics ($-30^{\circ}\text{C} < T_J < 115^{\circ}\text{C}$)

symbol	parameter	min	typ	max	unit
supply					
V_{DD-A}	supply voltage (analog)	3.14	3.3	3.47	V
V_{DD-IO}	supply voltage (digital I/O)	1.7	1.8	3.47	V
I_{DD-A}	active (operating) current		60	85	mA
I_{DD-D}			170	240	mA
I_{DD-IO}			30 ^a		mA
$I_{DDS-PWDN-A}$	standby current ^b		5		μA
$I_{DDS-PWDN-D}$			270		μA
$I_{DDS-PWDN-IO}$			10		μA
digital inputs (typical conditions: AVDD = 3.3V, DOVDD = 1.8V)					
V_{IL}	input voltage LOW			0.54	V
V_{IH}	input voltage HIGH	1.26			V
C_{IN}	input capacitor			10	pF
digital outputs (standard loading 25 pF)					
V_{OH}	output voltage HIGH	1.62			V
V_{OL}	output voltage LOW			0.18	V
serial interface inputs					
V_{IL}^c	SIOC and SIOD	-0.5	0.0	0.54	V
V_{IH}^c	SIOC and SIOD	1.26	1.8	2.3	V

- a. varies with loading
 b. standby current based on room temperature
 c. based on DOVDD = 1.8V; minimum input voltage high = $0.7 \times \text{DOVDD}$; maximum input voltage low = $0.3 \times \text{DOVDD}$; output voltage high = $0.9 \times \text{DOVDD}$; output voltage low = $0.1 \times \text{DOVDD}$.

8.4 AC characteristics

table 8-4 AC characteristics ($T_A = 25^\circ\text{C}$, $V_{DD-A} = 3.3\text{V}$, $V_{DD-I/O} = 1.8\text{V}$)

symbol	parameter	min	typ	max	unit
ADC parameters					
B	analog bandwidth		48		MHz
DLE	DC differential linearity error		<0.5		LSB
ILE	DC integral linearity error		<0.5		LSB
	settling time for software reset			<1	ms
	settling time for resolution mode change			<1	ms
	settling time for register setting			<300	ms

table 8-5 timing characteristics

symbol	parameter	min	typ	max	unit
oscillator and clock input					
f_{osc}	frequency (XVCLK)		24		MHz
t_r , t_f	clock input rise/fall time			5 (10^3)	ns

a. if using the internal PLL

Confidential for
Renesas Electronics
only

9 mechanical specifications

9.1 physical specifications

figure 9-1 package specifications

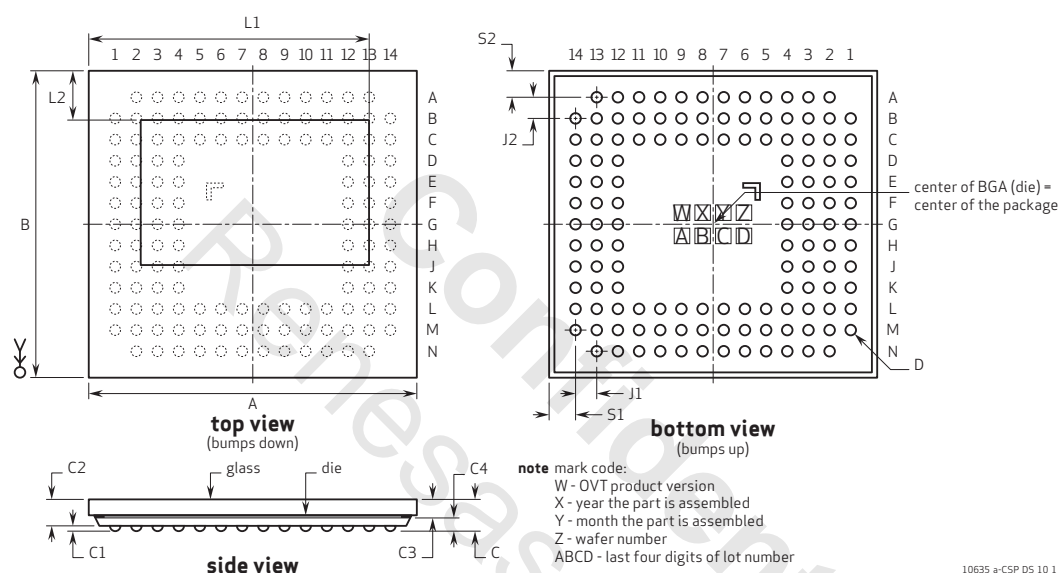

table 9-1 package dimensions (sheet 1 of 2)

parameter	symbol	min	typ	max	unit
package body dimension x	A	7770	7795	7820	μm
package body dimension y	B	7120	7145	7170	μm
package height	C	690	750	810	μm
ball height	C1	100	130	160	μm
package body thickness	C2	575	620	665	μm
thickness of glass surface to wafer	C3	425	445	465	μm
image plane height	C4	250	305	360	μm
ball diameter	D	220	250	280	μm
total pin count	N		129		
pin count x-axis	N1		14		
pin count y-axis	N2		13		

table 9-1 package dimensions (sheet 2 of 2)

parameter	symbol	min	typ	max	unit
pins pitch x-axis	J1		510		μm
pins pitch y-axis	J2		500		μm
first pixel to package edge dimension A	L1	6667.7	6702.7	6737.7	μm
first pixel to package edge dimension B	L2	1068.1	1103.1	1138.1	μm
edge-to-pin center distance along x	S1	553	583	613	μm
edge-to-pin center distance along y	S2	543	573	603	μm
air gap between die and glass		40	45	50	μm
tilt between die and glass				0.2	degree
die rotation				0.1	degree

Renesas Confidential for
only
Electronics

9.2 IR reflow specifications

figure 9-2 IR reflow ramp rate requirements

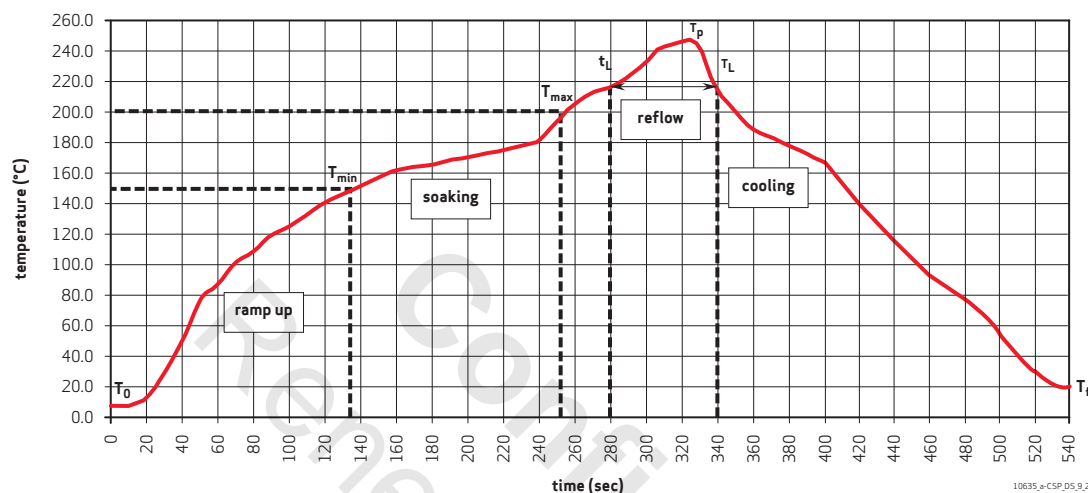

note

The OV10635/OV10135 uses a lead free package.

table 9-2 reflow conditions^{ab}

zone	description	exposure
ramp up A (T_0 to T_{min})	heating from room temperature to 150°C	temperature slope $\leq 3^\circ\text{C}$ per second
soaking	heating from 150°C to 200°C	90 ~ 150 seconds
ramp up B (t_L to T_P)	heating from 217°C to 245°C	temperature slope $\leq 3^\circ\text{C}$ per second
peak temperature	maximum temperature in SMT	245°C +0/-5°C (duration max 30 sec)
reflow (t_L to T_L)	temperature higher than 217°C	30 ~ 120 seconds
ramp down A (T_P to T_L)	cooling from 245°C to 217°C	temperature slope $\leq 3^\circ\text{C}$ per second
ramp down B (T_L to T_f)	cooling from 217°C to room temperature	temperature slope $\leq 2^\circ\text{C}$ per second
T_0 to T_P	room temperature to peak temperature	≤ 8 minutes

- maximum number of reflow cycles = 3
- N₂ gas reflow or control O₂ gas PPM<500 as recommendation



note

OmniVision recommends a-CSP packages use underfill as part of camera assembly process.

Confidential for
Renesas Electronics
only

10 optical specifications

10.1 sensor array center

figure 10-1 sensor array center

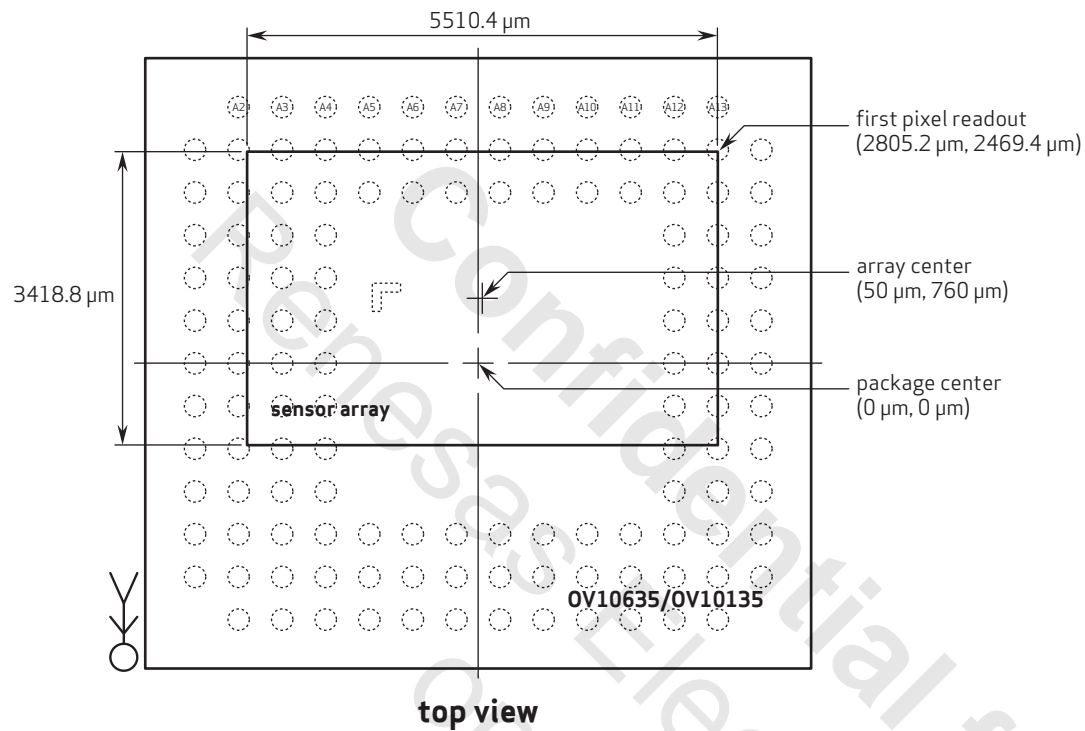

note 1 this drawing is not to scale and is for reference only.

note 2 as most optical assemblies invert and mirror the image, the chip is typically mounted with pin A2 to A13 oriented down on the PCB.

10635_a-CSP_DS_10_1

10.2 lens chief ray angle (CRA)

figure 10-2 chief ray angle (CRA)

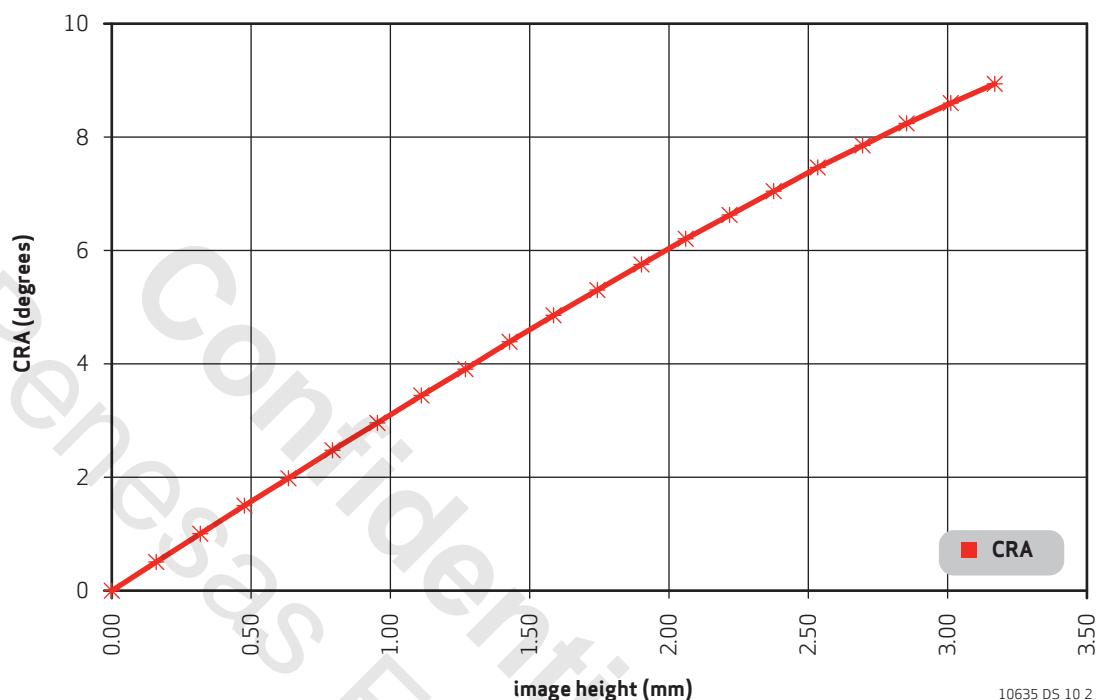

table 10-1 CRA versus image height plot (sheet 1 of 2)

field (%)	image height (mm)	CRA (degrees)
0.00	0.000	0.0
0.05	0.158	0.5
0.10	0.317	1.0
0.15	0.475	1.5
0.20	0.634	2.0
0.25	0.792	2.5
0.30	0.951	3.0
0.35	1.109	3.4
0.40	1.268	3.9
0.45	1.426	4.4

table 10-1 CRA versus image height plot (sheet 2 of 2)

field (%)	image height (mm)	CRA (degrees)
0.50	1.585	4.9
0.55	1.743	5.3
0.60	1.902	5.8
0.65	2.060	6.2
0.70	2.219	6.6
0.75	2.377	7.1
0.80	2.536	7.5
0.85	2.694	7.9
0.90	2.853	8.2
0.95	3.011	8.6
1.00	3.170	9.0

Renesas Confidential for
only
Electronics

10.3 spectrum response curve

Stray infrared light can affect image quality in various ways, from color crosstalk to internal reflections from metal surfaces. To reduce these artifacts, OmniVision recommends an IR-cut filter that maintains near 0% transmission from 700nm to 1200nm. The camera application, acceptable artifacts, and packaging type will dictate the exact IR-cut specifications. For further assistance, contact your regional OmniVision FAE.

figure 10-3 spectrum response curve diagram

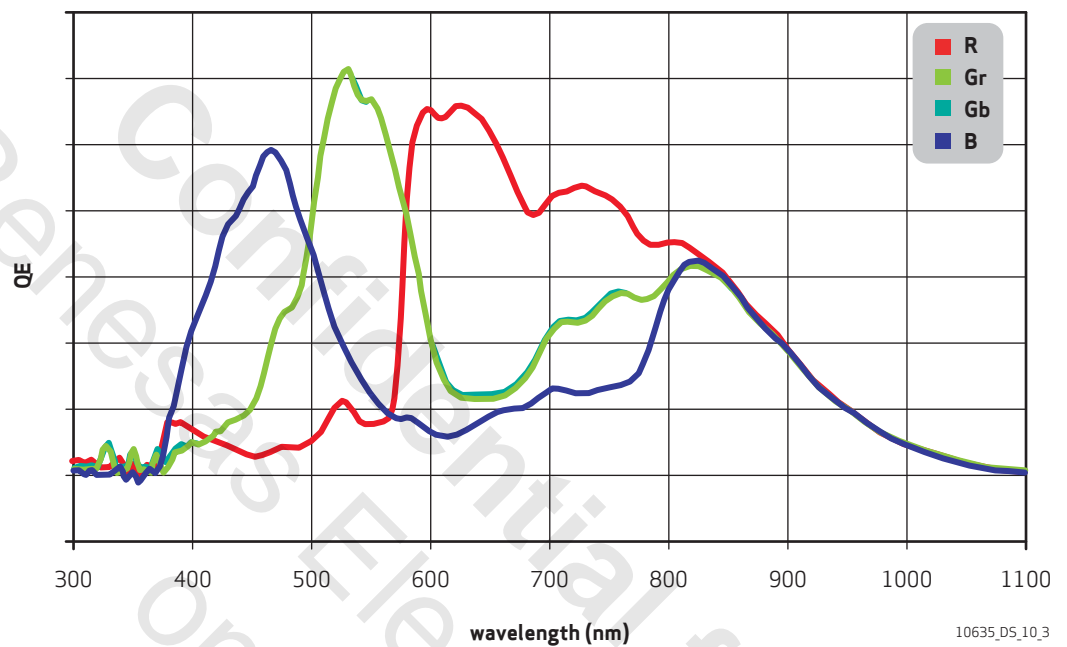

10635_DS_10_3

revision history

version 1.0 02.02.2012

- initial release

version 1.1 02.27.2012

- in ordering information, updated ordering part number information
- in features, added two notes "The OV10635/OV10135 is qualified to AEC-Q100 grade-2 specifications" and "To reduce image artifacts from Infrared light, and provide the best image quality, OmniVision recommends an IR cut filter"
- in key specifications, updated temperature range section by removing stable image, removing the "not guaranteed until AEC-Q100 qualification is completed" comment and changing the operating temperature from "-30°C to 115°C junction temperature" changed to "-40°C to 105°C junction temperature (operating junction temperatures above +60°C may result in degraded image quality)"
- in table 1-1, updated signal description of pin number C13 (VH) by removing "(requires a 0.1 μ F capacitor between VH and AGND)"
- in table 1-1, updated signal descriptions by adding the note, "Internal reference voltages require a 0.1 μ F capacitor to AGND", to pins C12 (VF), C13 (VH), A13 (VF4)
- in chapter 1, added table 1-2
- in chapter 2, updated section 2.1
- in section 2.3, added the following sentence "For further information on the registers affecting windowing, cropping, and skipping (subsampling), see section 4-3"
- in table 2-1, removed format "any size" and changed format "600 x 400" resolution to "640 x 400"
- in chapter 4, updated section 4.3
- in chapter 4, updated section 4.4
- in section 4.4.1 and section 4.4.2, modified paragraphs
- in chapter 4, updated figure 4-9
- in chapter 4, rewrote the description of section 4.5.1 and section 4.5.2
- in chapter 4, deleted section 4.5.3
- in chapter 4, modified section 4.5.3
- in chapter 5, modified section 5.1
- in chapter 5, modified section 5.2 and figure 5-1
- in chapter 5, modified section 5.3
- in chapter 5, deleted section 5.3.3 and added it to section 5.3.2
- in chapter 5, added figure 5-4
- in chapter 5, modified section 5.6
- in chapter 5, modified section 5.7
- in chapter 5, modified section 5.8
- in table 7-15, changed to low level filter (LLF) control
- in table 7-17, changed to normalize (NMLZ) control

- in table 7-18, changed to tone mapping (TMAP) control
- in table 7-9, changed to frame counter (FC) control
- in table 8-2, deleted stable image temperature

version 1.2 **03.23.2012**

- in table 1-1, added a row for pin C4
- updated figure 2-1
- in table 2-1, changed name of fourth column to "methodology"
- in section 10.3, added descriptive paragraph before figure 10-3

version 1.21 **03.28.2012**

- in key specifications, changed operating temperature from "-40°C to 105°C junction temperature..." to "-40°C to +105°C sensor ambient..."
- in table 4-1, added table footnote a
- in section 4.3, changed "This cropping..." to "Windowing..." in third sentence of section description
- in chapter 5, updated figure 5-1
- in table 8-2, changed operating temperature from "-40°C to +115°C junction temperature" to "-40°C to +105°C sensor ambient"

version 2.0 **05.22.2012**

- changed datasheet from preliminary specification to product specification
- in table 6-4, replaced all TBDs, changed t_{CKNVS} typical value from "1.5" to "0.5", t_{CKNVS} typical value from "1.5" to "1", t_{CKNHRR} typical value from "1" to "0", and t_{CKNHRR} typical value from "1" to "-0.5"

version 2.01 **06.29.2012**

- in table 5-2 and table 7-9, changed description of register bit 0x5080[5] from "Bit[5]: Auto LENC switch enable, 0: LENC gain adjust according to sensor gain; 1: LENC gain is fix to 'd16" to "Bit[5]: Auto LENC switch enable, 0: LENC gain is fixed; 1: LENC gain adjusts according to sensor gain"
- in table 7-4, removed row for 0x3823 and added row for registers 0x3848~0x3849 with description "Frame Counter for Debug"
- in section 9.2, replaced figure 9-2 and table 9-2

version 2.1 **02.04.2013**

- in section 9.1, added parameters to table 9-1 for first pixel to package edge dimension A, first pixel to package edge dimension B, air gap between die and glass, tilt between die and glass, and die rotation
- in section 9.2, updated figure 9-2 and replaced table 9-2 with new table

version 2.11 04.23.2013

- in table 1-2, changed all conditions for GPIO0, GPIO1, GPIO2, and GPIO3 to "input"
- in table 2-3, changed values in note b from "10%" to "30%" and "90%" to "70%"
- in table 8-1, added parameter for ambient storage temperature

version 2.12 05.07.2013

- in chapter 6, updated figure 6-1

version 2.13 05.22.2013

- in chapter 6, updated figure 6-1

version 2.14 02.19.2014

- in section 4.2, replaced last four sentences of the section description with "The analog test pattern is a color bar overlaid on an image, which can be enabled by register 0x370A[2]... ", added new paragraph to end of section description and removed table 4-2
- in table 4-6, changed bit descriptions for registers 0x562C and 0x562D from "...Long Exposure Sub-pixel" to "...Short Exposure Sub-pixel"
- in table 7-7, changed bit descriptions for registers 0x562A, 0x562B, from "... Short Exposure Sub-pixel" to "... Long Exposure Sub-pixel" and 0x562C, 0x562D from "...Long Exposure Sub-pixel" to "...Short Exposure Sub-pixel"

version 2.15 04.09.2014

- in table 7-2, changed bit description for register 0x4709 to "Bit[7]:Debug control; Bit[6:4]:Data bit swap..."

version 2.16 04.23.2014

- in chapter 7, removed table 7-25
- in table 8-3, added "minimum input voltage high = $0.7 \times \text{DOVDD}$; maximum input voltage low = $0.3 \times \text{DOVDD}$; output voltage high = $0.9 \times \text{DOVDD}$; output voltage low = $0.1 \times \text{DOVDD}$ " to table footnote c

version 2.17 11.11.2014

- in section 2.5, added "PLL adjustment should be applied while the sensor..." to end of section description

version 2.2 **01.09.2015**

- in chapter 6, replaced section 6.1 with new information

version 2.3 **06.04.2015**

- in key specifications, added sidebar note
- in table 4-3, added bit description for register 0x3621[2:0]
- in table 4-5, added bit description for register 0x3621[2:0]
- in table 4-6, changed default value to "-" and added register value information to end of bit description for registers 0xC2F0~0xC30A, 0xC450, 0xC452~0xC454, 0xC456~0xC45C, 0xC45E~0xC462, 0xC464~0xC479, 0xC47C~0xC490, 0xC492~0xC493, 0xC498~0xC499, 0xC49A~0xC4AD, 0xC4B1~0xC4B3, 0xC514~0xC515, and 0xC518~0xC519
- in table 5-3, changed default value to "-" and added register value information to end of bit description for register 0xC4B8
- in table 5-7, changed default value to "-" and added register value information to end of bit description for registers 0xC2E6~0xC2E7
- in table 5-10, changed default value to "-" and added register value information to end of bit description for registers 0xC318~0xC347
- in table 5-11, changed default value to "-" and added register value information to end of bit description for registers 0xC314~0xC317
- in table 5-12, changed default value to "-" and added register value information to end of bit description for registers 0xC4B4~0xC4B6, 0xC4BC~0xC4C6, and 0xC4C8~0xC4CB
- in table 5-14, changed default value to "-" and added register value information to end of bit description for registers 0xC4E4~0xC4F9
- in section 7, changed "...the low 3 bits can..." to "...the low 3 bits come..." in section description and added "In order to guarantee reasonable performance,..." to end of section description
- in table 7-4, added register 0x382B and added bit description for register 0x3824[6]
- in table 7-6, changed default value to "-" and added register value information to end of bit description for registers 0xC4B7, 0xC4E0~0xC4E3, and 0xC4FA~0xC50F
- in table 7-7, changed default value to "-" and added register value information to end of bit description for registers 0xC2F0~0xC30A, 0xC450, 0xC452~0xC454, 0xC456~0xC45C, 0xC45E~0xC462, 0xC464~0xC479, 0xC47C~0xC490, 0xC492~0xC493, 0xC498~0xC499, 0xC49A~0xC4AD, 0xC4B1~0xC4B3, 0xC514~0xC515, and 0xC518~0xC519
- in table 7-11, changed default value to "-" and added register value information to end of bit description for registers 0xC4B8~0xC4BA and 0xC4CC~0xC4D1
- in table 7-14, changed default value to "-" and added register value information to end of bit description for registers 0xC318~0xC347
- in table 7-16, changed default value to "-" and added register value information to end of bit description for registers 0xC30C~0xC30E, 0xC30F, 0xC4B4~0xC4B6, and 0xC4BC~0xC4CB
- in table 7-18, changed default value to "-" and added register value information to end of bit description for registers 0xC4E4~0xC4F9
- in section 7, added section 7.26
- in table 9-1, changed tilt between die and glass value from 0.12 to 0.2 and die rotation value from 0.2 to 0.1

version 2.4

11.06.2015

- in section 4.3, added "VTS is adjusted by registers (0x6E42[7:0], 0x6E43[7:0]). The reference initialization settings must be used for these two registers to be valid." to end of section description
- in table 4-6, added register 0xC2ED
- in table 7-7, added register 0xC2ED

Confidential for
Renesas Electronics
only

Confidential for
Renesas Electronics
only

defining the future of digital imaging™

Confidential for
Renesas Electronics only

OmniVision Technologies, Inc.

UNITED STATES

4275 Burton Drive
Santa Clara, CA 95054

tel: +1 408 567 3000
fax: +1 408 567 3001
email: sales@ovt.com

UNITED KINGDOM

Hook, Hampshire +44 1256 744 610

GERMANY

Munich +49 89 63 81 99 88

INDIA

Bangalore +91 80 4112 8966

CHINA

Beijing + 86 10 6580 1690
Shanghai + 86 21 6175 9888
+86 21 5774 9288
Shenzhen + 86 755 8384 9733

JAPAN

Yokohama +81 45 478 7977
Kyoto +81 75 708 5352

KOREA

Seoul + 82 2 3472 3769

SINGAPORE +65 6933 1933

TAIWAN

Taipei +886 2 2657 9800
Hsin-chu +886 3 5656688