

Wayland & V4l2 performance proposal - V4l2 dma cache maintenance optimization

12/07/2016
KURO.

OPEN SOURCE DEVELOPMENT CENTER SECTION 3
RENESAS ELECTRONICS CORPORATION

AGENDA

- V4I2 performance proposal using wayland compositor
 - Introduction: About Wayland/Weston and V4I2
 - Performance target and issue
 - Our investigate result, and approaches (for local patch).

- Appendix
 - Show another requests for long term or middle term .
- Appendix 2
 - Introduce customer's requirement, and HW data flow.

Introduction

- About Weston (Wayland compositor) & V4I2

- **Weston** is Window system.
- **Weston** is SW architecture as compositor.
 - It compose output surface from some input buffers.
 - It has rendering component, called “renderer”.
 - Weston can select one “renderer” to use HW resource.
- The figure shows typical renderers.

1. gl-renderer (GPU): OpenGL ES API, it is default renderer.

Name	HW	API	Remarks
gl-renderer	GPU	OpenGL/ES 2.0	Default renderer
pixman-renderer	CPU	Pixman library	For reference SW
v4l2-renderer	VSP	V4I2	Renesas Original SW

– http://events.linuxfoundation.org/sites/events/files/slides/ais2015_wayland.pdf

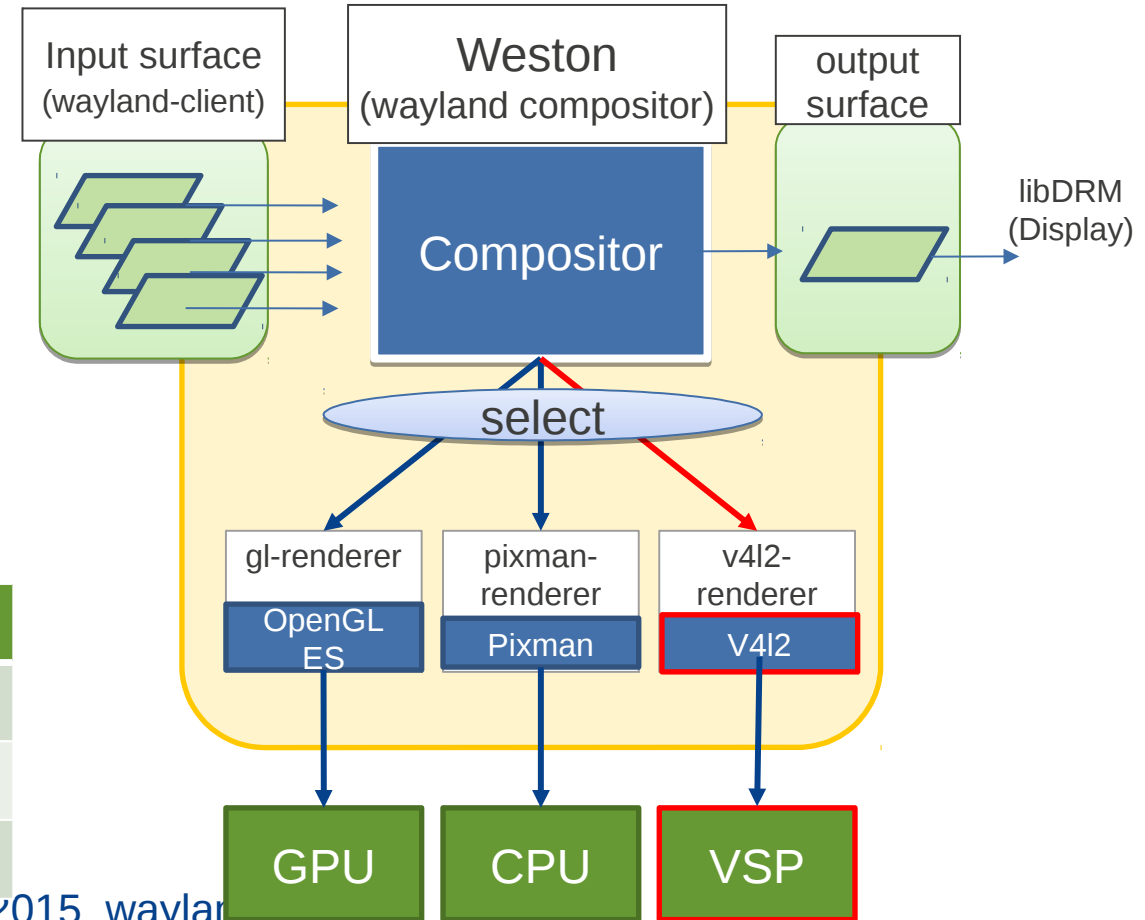

Why does we develop v4l2-renderer?

- GPU Offloading
 - Most of IVI Applications require high Graphics resource.
 - 3D Navigation System, HMI, 3D effect, etc.
 - User want to use GPU for more advanced UI, rather than a simple window composition.

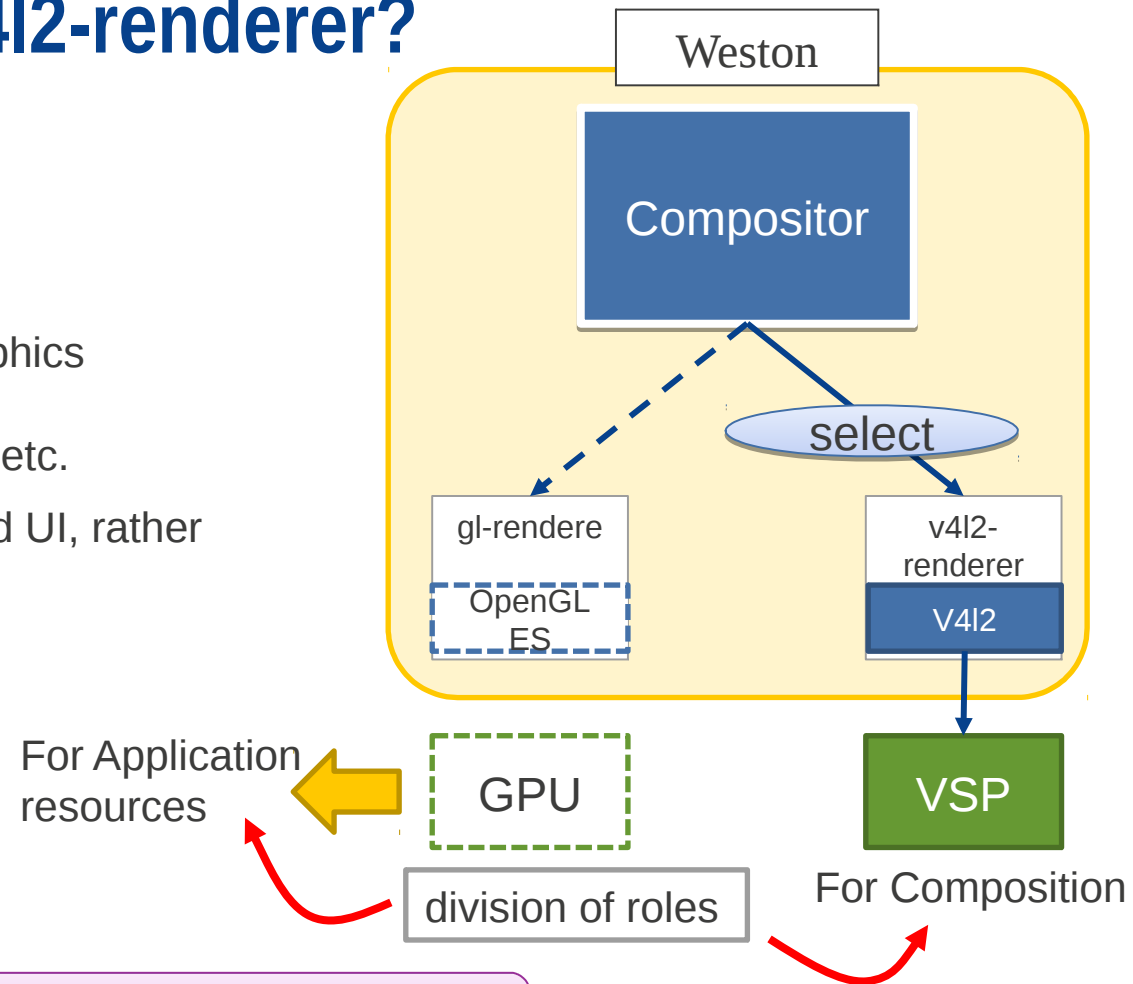

We use VSP to compose in order to reduce Total performance cost.

Performance TARGET and issue

- Target : It must complete within 1vsync, i.e. within 16.6ms.

However,

- HW processing time for composition increase in proportion to resolution. (Full HD size : about 8000us.)
- VSP has only 5 inputs (Gen2 vsp has 4 inputs).
 - When the number of surface is over 5, VSP composition should takes twice or over. When there is 8 surface images,
 - 1st : 5 surface is composed.
 - 2nd : 3 surface and one output buffer.
- Not only HW over head, but also SW overhead should be reduced.
(Panasonic said "100us or less") $\leq 1\%$ of 16.6ms

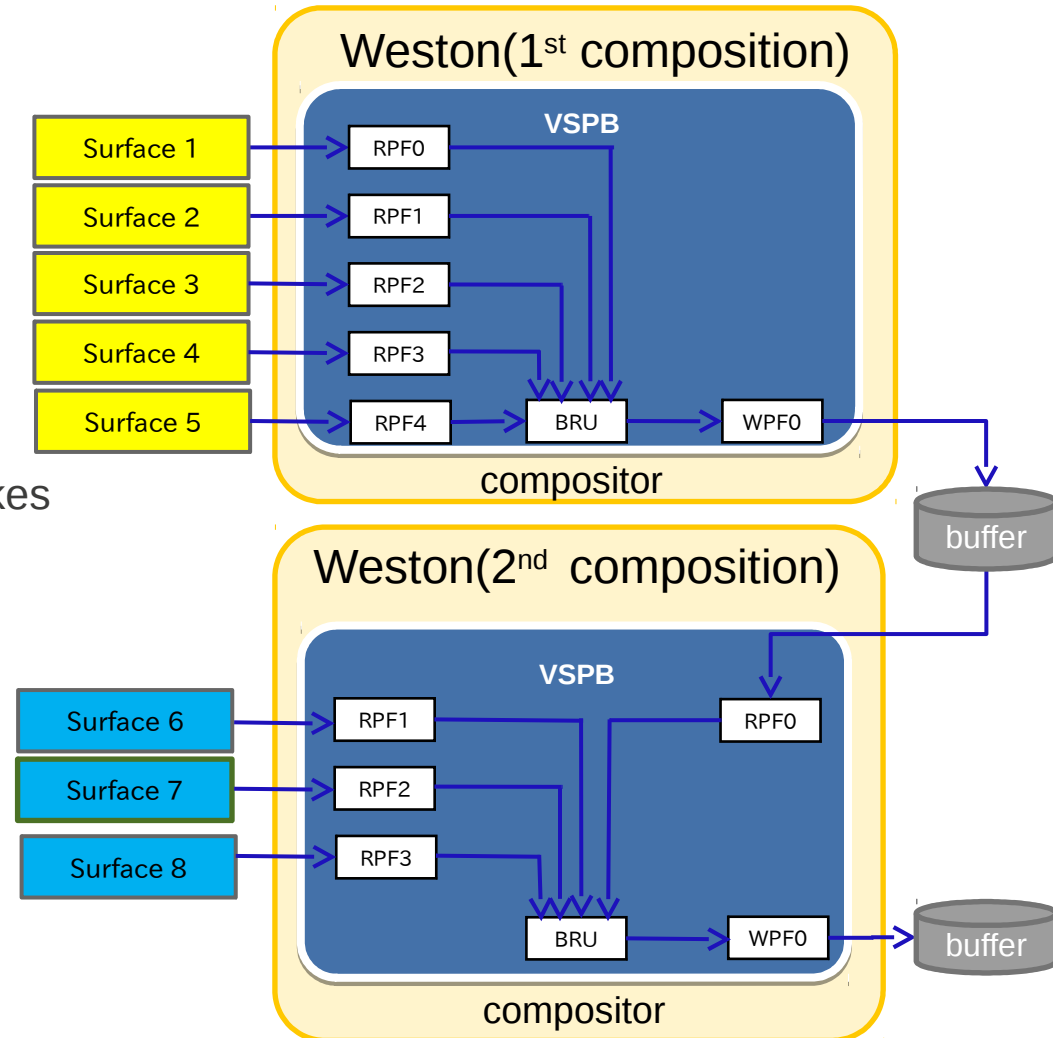

Example (Timing Chart) : problems

- There is extra process time except HW.
In out investigation, it is cased QBUF/DQBUF. It takes long time.

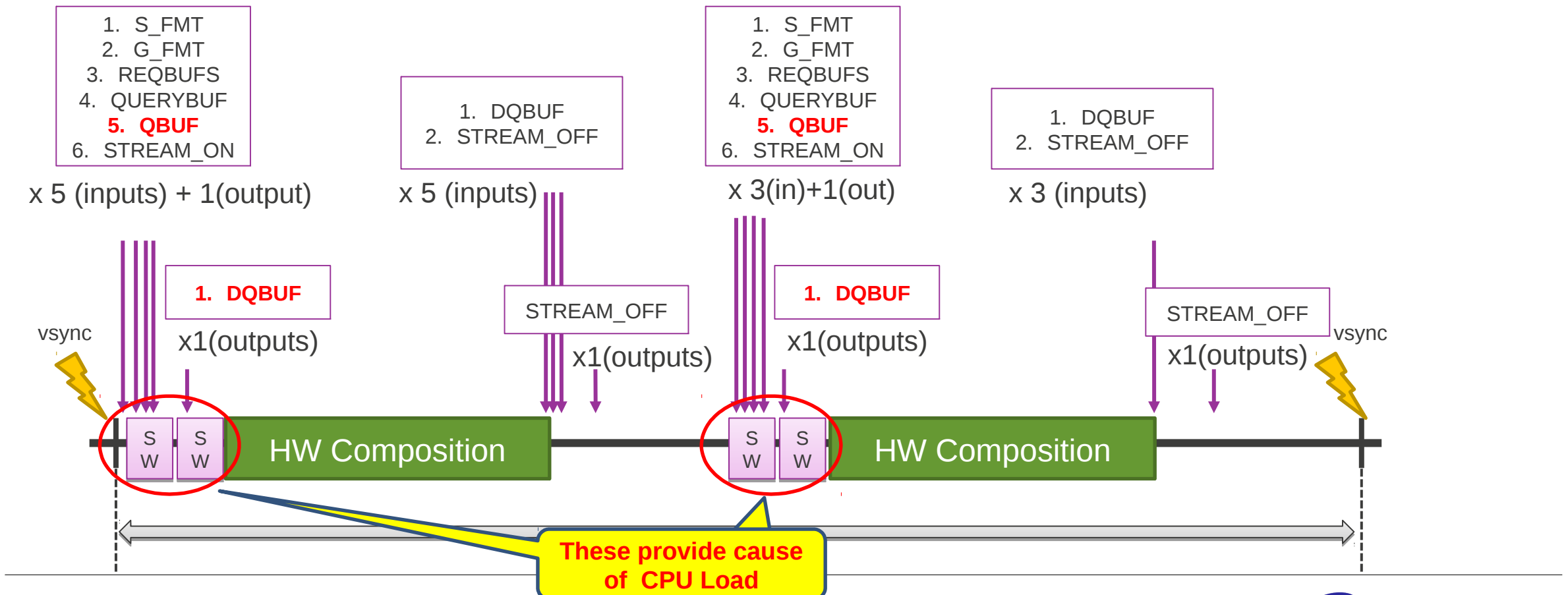

Why this CPU load is problem?

- We found out V4l2 CPU load is caused CPU cache flush process. But, this memory area is non-cached.

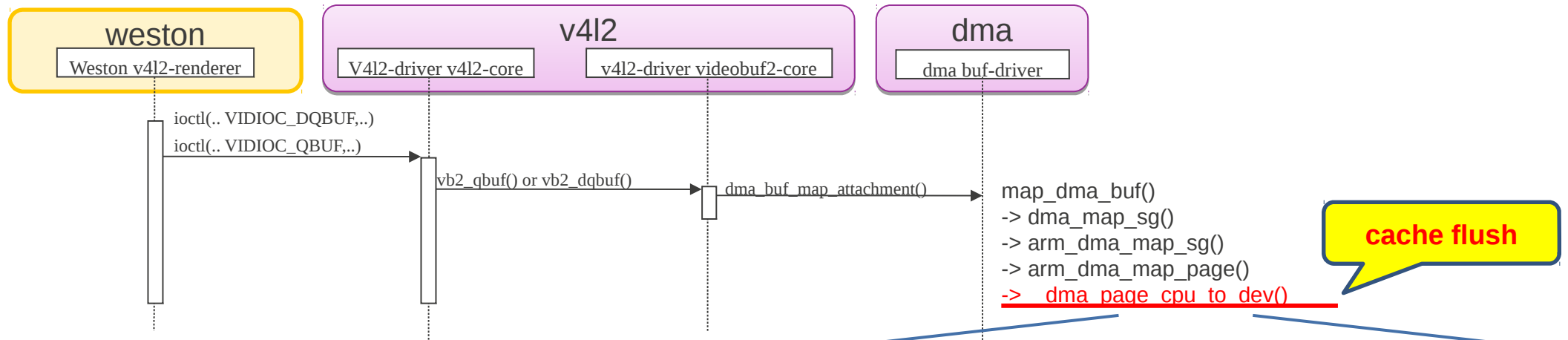

- Another case :
 - 800x480:100µs/oneQBUF
 - 1280x480:160µs/one QBUF.

=> The progress time increases in proportion to display resolution.
In 4K display case, it will take 7ms over only this CPU load.

CPU load:	Time(us)	
QBUF(RPF: input)	600us + other	Full HD display and other input surfaces. e.g.) 250x250 surface takes 20us
QBUF(WPF:output)	600us	Full HD display
DQBUF(WPF:output)	600us	Full HD display
Total	1.8ms over	

Modification overview in Gen2 (It is just for customer's patch)

It shows the block diagram in our Gen2 solution. Please refer the attached patch file (skip_cache_mainte_v4l2.patch)

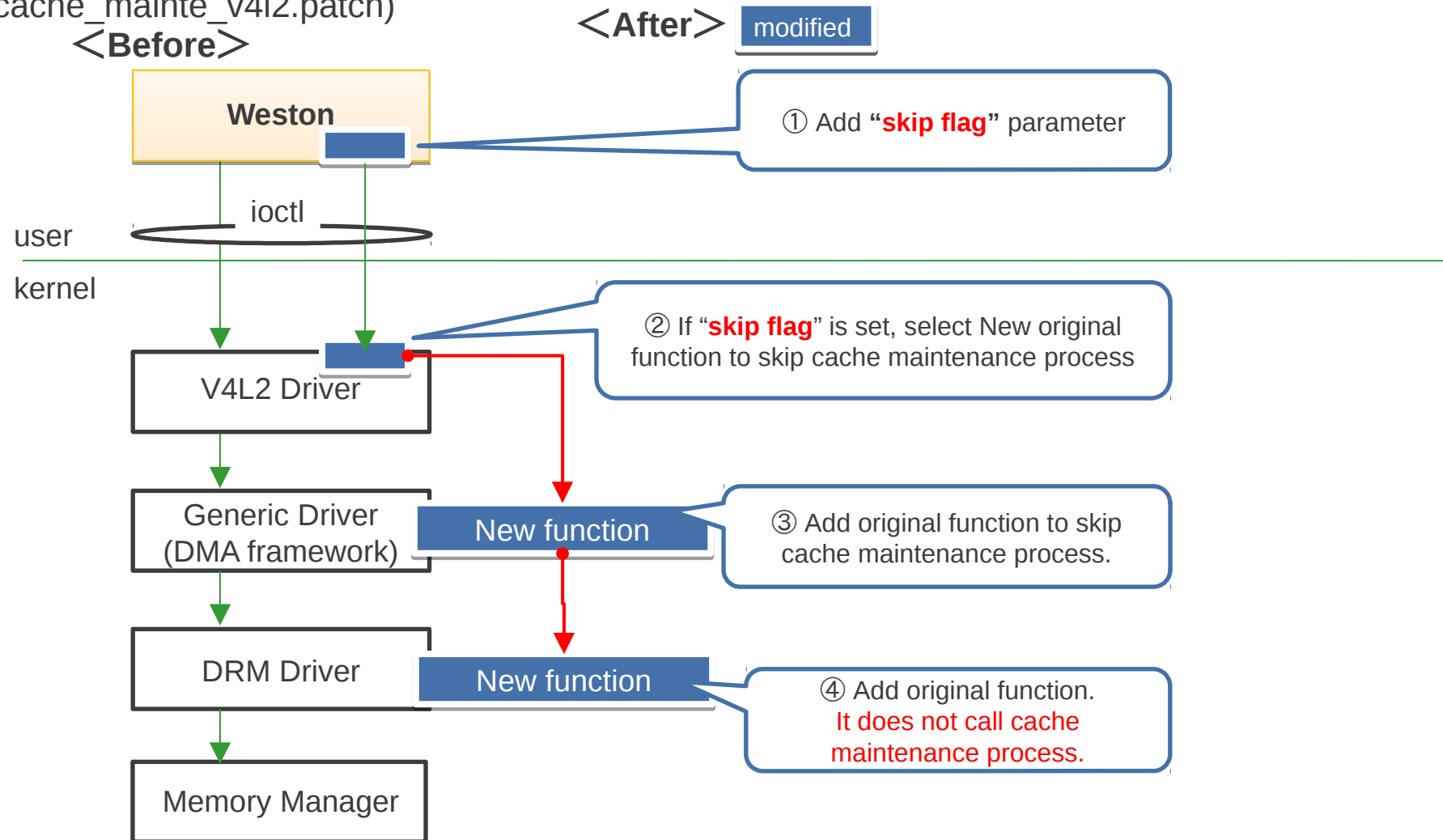

Conclusion

- We investigate and resolved in Gen2. We confirmed that It is effective.
- However, the patch is released for only 1 customer. Neither renesas BSP nor upstream.
- It is related for v4l2 framework and v4l2 interface, not related platform driver (vsp1), so that we have requested for you.

Appendix

- Another Request For Media

図を追加

Background of many requests for VSPs



SW component for Gen2 (VSP-D / VSP-S / FDP)

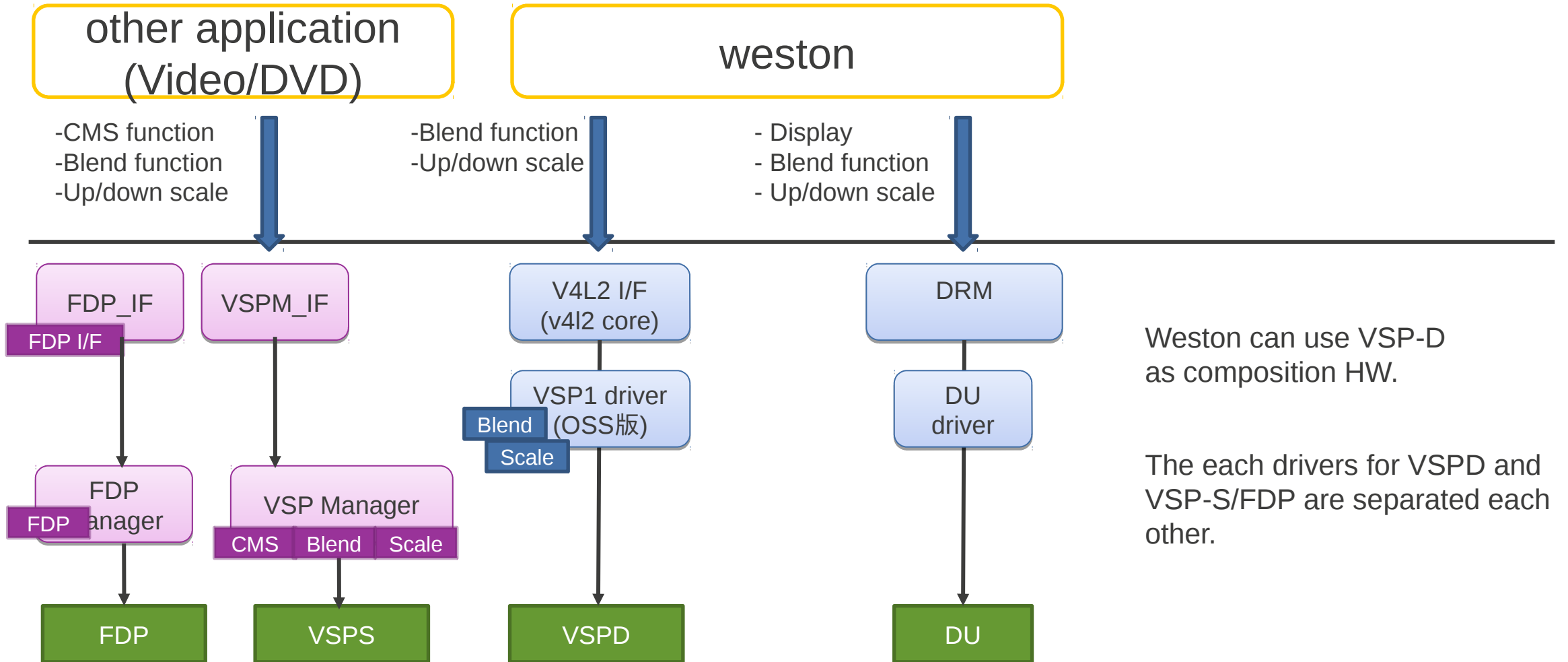

Current Renesas BSP component in Gen3

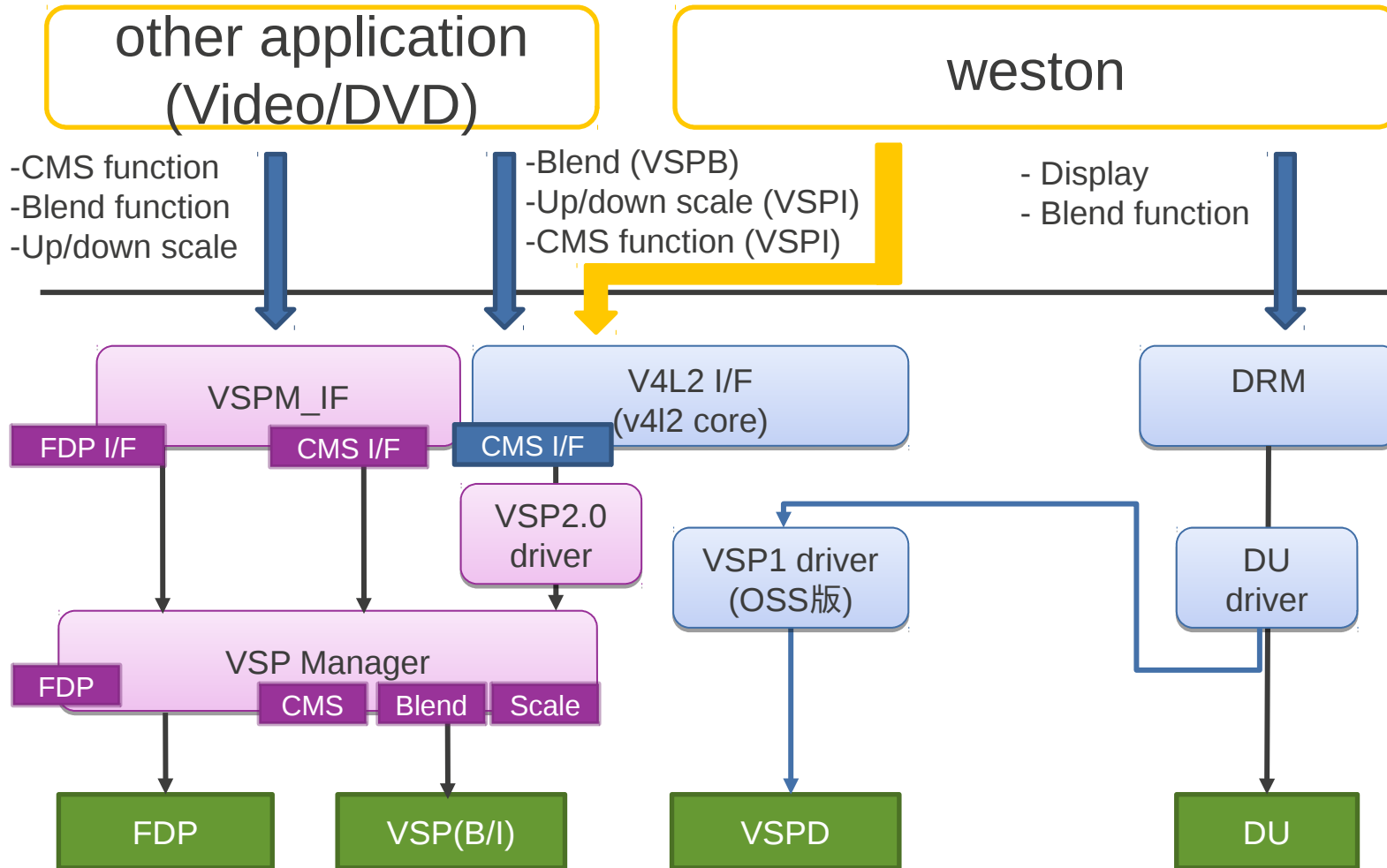

[Gen3]
VSPD should be used for Display together with DU, and it is controlled by libdrm.
Then, all of application need to share VSPB or VSPI.

- ① Most of application/Library use VSPM_IF. Because it should keep compatible Gen2 API, and some functions are supported.
- ② CMS library what is Renesas proprietary library use v4l2 API, step by step
- ③ Weston use v4l2 to blend by VSPB.

There are two types of I/F, VSPM_IF and V4l2 I/F. We should unify I/F to V4l2 in order to upstream for v4l2-rendere.

Finally Gen3 platform propose

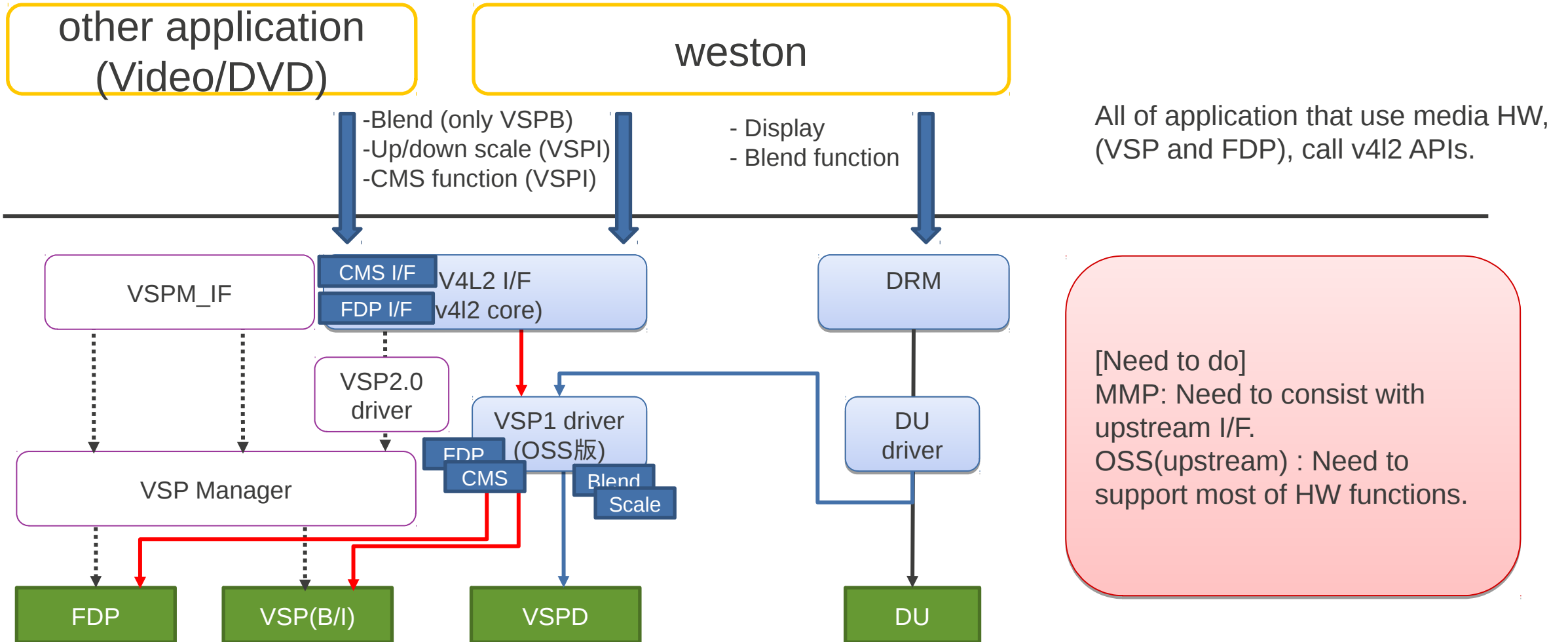

FUTURE REQUEST (SHORT /MIDDLE TERM)

Problem/request	Term	Category	Priority	Status/remarks
To be fix VSP CMS I/F	on going	New function	High	Already requested.
FDP driver	on going	New driver	Middle	Already requested.
UDS/WPF Image Partition	Short/Middle term	Function expand	High	Already requested.
Request API	Short/Middle term	Performance	High	Already requested.
New I/F for Virtual Input (RPF via V4I2&libDRM)	Short/Middle term	Function expand (Add I/F) (based on Customer Use-case)	Middle	Not yet request.
Up/down scale video surface during stream-on.	Short/Middle term	Customer Use-case. (based on Customer Use-case)	Middle	Not yet request
FCP Lossless (VSP(WPF) + FCPV)	Short/Middle term	Function expand (Add I/F)	Low	Low priority.
FCP Lossless (FDP + FCPC)	Short/Middle term	Function expand (Add I/F)	Low	Low priority.

FUTURE REQUEST (LONG TERM)

Problem/request	Term	Category	Priority	Remarks
Dma-cache reduce	Middle	Performance	Middle	Already requested.
Change the proper media_device_info value	Middle	Function expand	Middle	driver, model, bus_info etc. string is not proper.
VSPD Write-back	Middle	Function expand	Low	BSP has improved already. To be upstream
H3 ES2.0 and M3N /E3 VSPD-DU	Middle term	New SoC	Middle	BSP will improve at first in Japan. To be upstream soon.
Compatible support format between VIN and VSP.	Middle term	System/Customer Use-case	Middle	Complete today
Multi process	Long term	System/Customer Use-case	High	Already discuss at Nov/2015.

www.renesas.com